

CONSTRUCTION AND TECHNICAL SPECIFICATIONS

FOR

GLENDALE FIRE STATION



PREPARED FOR:

WALTON COUNTY

PREPARED BY:



February 2024

PROJECT #: 50150622

TABLE OF CONTENTS FOR GLENDALE FIRE STATION

| <u>BIDDING AND CONTRACT DOCUMENTS</u> | | | <u>PAGES</u> |
|--|--------------------------|------------------------------|---------------------|
| Document No. 1 | Section 00015 | Project Overview | 1 |
| Document No. 2 | Section 00030 | Bid Form | 1-3 |
| Document No. 3 | Section 00100 | Change Order | 1-2 |
| Document No. 4 | Section 00110 | General Conditions | 1-15 |
| <u>GENERAL REQUIREMENTS</u> | | | <u>PAGES</u> |
| Document No. 1 | Section 01030 | Alternates | 1 |
| Document No. 2 | Section 01090 | Definitions and Standards | 1-4 |
| Document No. 3 | Section 01155 | Schedules, Reports, Payments | 1-2 |
| Document No. 4 | Section 01205 | Procedures and Controls | 1-4 |
| Document No. 5 | Section 01340 | Submittals | 1-2 |
| Document No. 6 | Section 01605 | Products and Substitutions | 1-4 |
| Document No. 7 | Section 01705 | Project Closeout | 1-4 |
| <u>SITWORK</u> | | | <u>PAGES</u> |
| Document No. 1 | Section 02110 | Site Clearing | 1-3 |
| Document No. 2 | Section 02200 | Earthwork | 1-8 |
| Document No. 3 | Section 02210 | Grassing | 1-4 |
| Document No. 4 | Section 02211 | Sodding | 1-3 |
| Document No. 5 | Section 02800 | Irrigation | 1-5 |
| Document No. 6 | Section 02830 | Chain Link Fencing and Gates | 1-5 |

| <u>ASPHALT</u> | | | <u>PAGES</u> |
|------------------------|---------------|--|---------------------|
| Document No. 1 | Section 02500 | Paving Quality Control System | 1 |
| Document No. 2 | Section 02505 | Paving Construction Details and Materials | 1 |
| Document No. 3 | Section 02510 | General Construction Requirements for Asphalt Testing | 1-11 |
| Document No. 4 | Section 02516 | Limerock Base Course | 1-3 |
| Document No. 5 | Section 02518 | Painting Traffic Stripes | 1-4 |
| Document No. 6 | Section 02519 | Sand-Clay Base | 1-3 |
| Document No. 7 | Section 02520 | Asphalt Testing | 1-2 |
| <u>CONCRETE</u> | | | <u>PAGES</u> |
| Document No. 1 | Section 03310 | Concrete Work | 1-15 |
| Document No. 2 | Section 03390 | Curing, Sealing, and Hardening Concrete Floors | 1-3 |
| <u>BUILDING</u> | | | <u>PAGES</u> |
| Document No. 1 | Section 05120 | Structural Steel | 1-11 |
| Document No. 2 | Section 05400 | Cold-Formed Metal Framing | 1-9 |
| Document No. 3 | Section 05500 | Metal Fabrication | 1-9 |
| Document No. 4 | Section 06100 | Rough Carpentry | 1-7 |
| Document No. 5 | Section 06402 | Interior Architectural Woodwork | 1-9 |
| Document No. 6 | Section 07210 | Building Insulation | 1-5 |
| Document No. 7 | Section 07620 | Sheet Metal Flashing and Trim | 1-6 |
| Document No. 8 | Section 07901 | Joint Sealants | 1-11 |
| Document No. 9 | Section 07910 | Joint Firestopping | 1-9 |

| | | | |
|--------------------------|---------------|--|---------------------|
| Document No. 10 | Section 07920 | Penetration Firestopping | 1-7 |
| Document No. 11 | Section 07930 | Water Repellents | 1-8 |
| Document No. 12 | Section 08110 | Steel Doors and Frames | 1-6 |
| Document No. 13 | Section 08210 | Wood Doors | 1-4 |
| Document No. 14 | Section 08360 | Sectional Overhead Doors | 1-5 |
| Document No. 15 | Section 08400 | Glass, Glazing and Aluminum Windows | 1-8 |
| Document No. 16 | Section 08710 | Door Hardware | 1-13 |
| Document No. 17 | Section 09255 | Gypsum Board Assemblies | 1-15 |
| Document No. 18 | Section 09310 | Ceramic Tile | 1-10 |
| Document No. 19 | Section 09670 | Fluid Applied Resinous Floorings | 1-5 |
| Document No. 20 | Section 09900 | Painting | 1-12 |
| Document No. 21 | Section 09910 | Light Commercial / Residential Painting | 1-7 |
| Document No. 22 | Section 10810 | Toiletry Accessories | 1-2 |
| Document No. 23 | Section 12300 | Fire Extinguishers, Cabinets and Accessories | 1-4 |
| Document No. 24 | Section 12366 | Solid Surface Countertops | 1-6 |
| Document No. 25 | Section 12370 | Wood Cabinets | 1-6 |
| Document No. 26 | Section 12375 | Wood Veneer Cabinets | 1-9 |
| <u>PEMB</u> | | | <u>PAGES</u> |
| Document No.1 | Section 13000 | Metal Building Systems | 1-15 |
| <u>MECHANICAL</u> | | | <u>PAGES</u> |
| Document No. 1 | Section 15010 | Basic Mechanical Requirements | 1-3 |
| Document No. 2 | Section 15051 | Mechanical Related Work | 1-2 |
| Document No. 3 | Section 15060 | Pipe and Pipe Fittings | 1-6 |

| | | | |
|----------------|---------------|---------------------------------|-----|
| Document No. 4 | Section 15065 | Gravity Sanitary Sewage Systems | 1-4 |
| Document No. 5 | Section 15100 | Valves and Gates | 1-9 |
| Document No. 6 | Section 15120 | Piping Specialties | 1-3 |

STORMWATER CONVEYANCE

PAGES

| | | | |
|----------------|----------------|-----------------------|-----|
| Document No. 1 | Section 334200 | Stormwater Conveyance | 1-9 |
|----------------|----------------|-----------------------|-----|

APPENDICIES

| | |
|------------|---|
| APPENDIX A | General Vicinity Map and Location Maps |
| APPENDIX B | Geotechnical Report |
| APPENDIX C | Roof Panel Installation Guide |
| APPENDIX D | 10-2 Self Certification for Stormawater |
| APPENDIX E | Septic Permit |
| APPENDIX F | Water Storage Tank Pad Detail |

TECHNICAL SPECIFICATIONS FOR GLENDALE FIRE STATION SECTION 00015-PROJECT OVERVIEW

The project includes the construction of a new 8,120-sf pre-fabricated / engineered steel and wood construction fire station for Walton County Fire Rescue. Project scope includes mechanical, electrical, plumbing, building construction, and site work. The project site is located northeast of the intersection of SR-83 and County Highway 2, located in Glendale, Walton County, Florida. The property is approximately 7.58 acres and is identified by parcel # 27-5N-19-21000-001-0040 based on Walton County Property Appraiser data. The existing site is currently undeveloped. Water and sewer are currently not available to the site. **Please refer to the bidding and contract specifications for more information.**

CHANGE ORDER

Order No. _____

Date: _____

Agreement Date: _____

Name of Project: _____

Owner: _____

Contractor: _____

The following changes are hereby made to the Contract Documents:

Justification:

ORIGINAL Contract Price: _____

PREVIOUS CHANGES to Contract Price: _____

Current Contract Price adjusted by PREVIOUS Change Order: _____

The Contract Price due to this Change Order will be (INCREASED) (DECREASED)

By: _____

The NEW Contract Price including THIS Change Order will be: _____

Change CONTRACT TIME:

The CONTRACT TIME will be (INCREASED) (DECREASED) by: _____

calendar days.

The DATE FOR COMPLETION of all work will be _____
(Date)

Approvals Required:

Owner: _____

Contractor: _____

Engineer: _____

**TECHNICAL SPECIFICATIONS FOR GLENDALE FIRE STATION
SECTION 00110-GENERAL CONDITIONS**

1. Definitions
2. Additional Instructions and Detail Drawings
3. Schedules, Reports, and Records
4. Drawings and Specifications
5. Shop Drawings
6. Materials, Services, and Facilities
7. Inspection and Testing
8. Substitutions
9. Patents
10. Surveys, Permits, Regulations
11. Protection of Work, Property, Persons
12. Supervision by Contractor
13. Changes in the Work
14. Changes in Contract Price
15. Time for Completion and Liquidated Damages
16. Correction of Work
17. Subsurface Conditions
18. Suspension of Work, Termination, and Delay
19. Assignments
20. Indemnification
21. Separate Contracts
22. Subcontracting
23. Engineer's Authority
24. Land and Rights-of-Way
25. Guarantee
26. Arbitration (Not Applicable)
27. Taxes

1. DEFINITIONS

1.1 Wherever used in the Contract Documents, the following terms shall have the meanings indicated and shall be applicable to both the singular and plural thereof:

1.2 **ADDENDA** - Written or graphic instruments issued prior to the execution of the Agreement which modify or interpret the **CONTRACT DOCUMENTS, DRAWINGS and SPECIFICATIONS**, by additions, deletions, clarifications, or corrections.

1.3 **BID** - The offer or proposal of the **BIDDER** submitted on the prescribed form setting forth the prices for the **WORK** to be performed.

1.4 **BIDDER** - Any person, firm, or corporation submitting a **BID** for the **WORK**.

1.5 BONDS - Bid, Performance, and Payment Bonds and other instruments of surety, furnished by the CONTRACTOR and the CONTRACTOR'S surety in accordance with the CONTRACT DOCUMENTS.

1.6 CHANGE ORDER - A written order to the CONTRACTOR authorizing an addition, deletion, or revision in the WORK within the general scope of the CONTRACT DOCUMENTS, or authorizing an adjustment in the CONTRACT PRICE or CONTRACT TIME.

1.7 CONTRACT DOCUMENTS - The contract, including Advertisement for BIDS, Information for BIDDERS, BID, BID BOND, Agreement, Payment BOND, Performance BOND, NOTICE OF AWARD, NOTICE TO PROCEED, CHANGE ORDER, DRAWINGS, SPECIFICATIONS, and ADDENDA.

1.8 CONTRACT PRICE - The total monies payable to the CONTRACTOR under the terms and conditions of the CONTRACT DOCUMENTS.

1.9 CONTRACT TIME - The number of calendar days stated in the CONTRACT DOCUMENTS for the completion of the WORK.

1.10 CONTRACTOR - The person, firm or corporation with whom the OWNERS has executed the Agreement.

1.11 DRAWINGS - The parts of the CONTRACT DOCUMENTS which show the characteristics and scope of the WORK to be performed and which have been prepared or approved by the ENGINEER.

1.12 ENGINEER - The person, firm, or corporation named as such in the CONTRACT DOCUMENTS.

1.13 FIELD ORDER - A written order effecting a change in the WORK not involving an adjustment in the CONTRACT PRICE or an extension of the CONTRACT TIME, issued by the ENGINEER to the CONTRACTOR during construction.

1.14 NOTICE OF AWARD - The written notice of the acceptance of the BID from the OWNERS to the successful BIDDER.

1.15 NOTICE TO PROCEED - Written communication issued by the OWNERS to the CONTRACTOR authorizing him/her to proceed with the WORK and establishing the date for commencement of the WORK.

1.16 OWNERS - A public or quasi-public body or authority, corporation, association, partnership, or an individual for whom the WORK is to be performed.

1.17 PROJECT - The undertaking to be performed as provided in the CONTRACT DOCUMENTS.

1.18 RESIDENT PROJECT REPRESENTATIVE - The authorized representative of the OWNERS who is assigned to the PROJECT site or any part thereof.

1.19 SHOP DRAWINGS - All drawings, diagrams, illustrations, brochures, schedules and other data which are prepared by the CONTRACTOR, a SUBCONTRACTOR, manufacturer, SUPPLIER or distributor, which illustrate how specific portions of the WORK shall be fabricated or installed.

1.20 SPECIFICATIONS - A part of the CONTRACT DOCUMENTS consisting of written descriptions of a technical nature of materials, equipment, construction systems, standards and workmanship.

1.21 SUBCONTRACTOR - An individual, firm, or corporation having a direct contract with CONTRACTOR or with any other SUBCONTRACTOR for the performance of a part of the WORK at the site.

1.22 SUBSTANTIAL COMPLETION - That date certified by the ENGINEER when the construction of the PROJECT or a specified part thereof is sufficiently completed, in accordance with the CONTRACT DOCUMENTS, so that the PROJECT or specified part can be utilized for the purposes for which it is intended.

1.23 SUPPLEMENTAL GENERAL CONDITIONS - Modifications to General Conditions required by a State agency for participation in the PROJECT and approved by the agency in writing prior to inclusion in the CONTRACT DOCUMENTS, or such requirements that may be imposed by applicable state laws or by the OWNERS' governing regulations.

1.24 SUPPLIER - Any person or organization who supplies materials or equipment for the WORK, including that fabricated to a special design, but who does not perform labor at the site.

1.25 WORK - All labor necessary to produce the construction required by the CONTRACT DOCUMENTS, and all materials and equipment incorporated or to be incorporated in the PROJECT.

1.26 WRITTEN NOTICE - Any notice to any party of the Agreement relative to any part of this Agreement in writing and considered delivered and the service thereof completed, when posted by certified or registered mail to the said party at their last given address, or delivered in person to said party or their authorized representative on the WORK.

2. ADDITIONAL INSTRUCTION AND DETAIL DRAWINGS

2.1 The CONTRACTOR may be furnished additional instructions and detail drawings, by the ENGINEER, as necessary to carry out the WORK required by the CONTRACT DOCUMENTS.

2.2 The additional drawings and instructions thus supplied will become a part of the CONTRACT DOCUMENTS. The CONTRACTOR shall carry out the WORK in accordance with the additional detail drawings and instructions.

3. SCHEDULES, REPORTS AND RECORDS

3.1 The CONTRACTOR shall submit to the OWNERS such schedule of quantities and costs, progress schedules, payrolls, reports, estimates, records and other data where applicable as are required by the CONTRACT DOCUMENTS for the WORK to be performed.

3.2 Prior to the first partial estimate the CONTRACTOR shall submit construction progress schedules showing the order in which the CONTRACTOR proposes to carry on the WORK, including dates at which the various parts of the WORK will be started, estimated date of completion of each part and, as applicable:

3.2.1 The dates at which special detail drawings will be required; and

3.2.2 Respective dates for submission of SHOP DRAWINGS, the beginning of manufacture, the testing and the installation of materials, supplies and equipment.

3.3 The CONTRACTOR shall also submit a schedule of payments that the CONTRACTOR anticipates will be earned during the course of the WORK.

4. DRAWINGS AND SPECIFICATIONS

4.1 The intent of the DRAWINGS and SPECIFICATIONS is that the CONTRACTOR shall furnish all labor, materials, tools, equipment, and transportation necessary for the proper execution of the WORK in accordance with the CONTRACT DOCUMENTS and all incidental work necessary to complete the PROJECT in an acceptable manner, ready for use, occupancy or operation by the OWNERS.

4.2 In case of conflict between the DRAWINGS and SPECIFICATIONS, the DRAWINGS shall govern. Figure dimensions on DRAWINGS shall govern over general DRAWINGS.

4.3 Any discrepancies found between the DRAWINGS and SPECIFICATIONS and site conditions or any inconsistencies or ambiguities in the DRAWINGS or SPECIFICATIONS shall be immediately reported to the ENGINEER, in writing, who shall promptly correct such inconsistencies or ambiguities in writing. WORK done by the CONTRACTOR after discovery of such discrepancies, inconsistencies or ambiguities shall be done at the CONTRACTOR'S risk.

5. SHOP DRAWINGS

5.1 The CONTRACTOR shall provide SHOP DRAWINGS as may be necessary for the prosecution of the WORK as required by the CONTRACT DOCUMENTS. The ENGINEER shall promptly review all SHOP DRAWINGS. The ENGINEER'S approval of any SHOP DRAWING shall not release the CONTRACTOR from responsibility for deviations from the CONTRACT DOCUMENTS. The approval of any SHOP DRAWING which substantially deviates from the requirement of the CONTRACT DOCUMENTS shall be evidenced by a CHANGE ORDER.

5.2 When submitted for the ENGINEER'S review, SHOP DRAWINGS shall bare the CONTRACTOR'S certification that he has reviewed, checked and approved the SHOP DRAWINGS and that they are in conformance with the requirements of the CONTRACT DOCUMENTS.

5.3 Portions of the WORK requiring a SHOP DRAWING or sample submission shall not begin until the SHOP DRAWING or submission has been approved by the ENGINEER. A copy of each approved SHOP DRAWING and each approved sample shall be kept in good order by the CONTRACTOR at the site and shall be available to the ENGINEER.

6. MATERIALS, SERVICES AND FACILITIES

6.1 It is understood that, except as otherwise specifically stated in the CONTRACT DOCUMENTS, the CONTRACTOR shall provide and pay for all materials, labor, tools, equipment, water, light, power, transportation, supervision, temporary construction of any nature, and all other services and facilities of any nature whatsoever necessary to execute, complete, and deliver the WORK within the specified time.

6.2 Materials and equipment shall be so stored as to insure the preservation of their quality and fitness for the WORK. Stored materials and equipment to be incorporated in the WORK shall be located so as to facilitate prompt inspection.

6.3 Manufactured articles, materials, and equipment shall be applied, installed, connected, erected, used, cleaned and conditioned as directed by the manufacturer.

6.4 Materials, supplies, or equipment shall be in accordance with samples submitted by the CONTRACTOR and approved by the ENGINEER.

6.5 Materials, supplies, or equipment to be incorporated into the WORK shall not be purchased by the CONTRACTOR or the SUBCONTRACTOR subject to chattel mortgage or under a conditional sale contract or other agreement by which an interest is retained by the seller.

7. INSPECTION AND TESTING

7.1 All materials and equipment used in the construction of the PROJECT shall be subject to adequate inspection and testing in accordance with generally accepted standards, as required and defined in the CONTRACT DOCUMENTS.

7.2 The OWNERS shall provide all inspection and testing services not required by the CONTRACT DOCUMENTS.

7.3 The CONTRACTOR shall provide at the CONTRACTOR'S expense all testing and inspection services required by the CONTRACT DOCUMENTS.

7.4 If the CONTRACT DOCUMENTS, laws, ordinances, rules, regulations or orders of any public authority having jurisdiction require any WORK to specifically be inspected, tested, or approved by someone other than the CONTRACTOR, the CONTRACTOR will give the ENGINEER timely notice of readiness. The CONTRACTOR will then furnish the ENGINEER the required certificates of inspection, testing or approval.

7.5 Inspections, tests, or approvals by the ENGINEER or others shall not relieve the CONTRACTOR from the obligations to perform the WORK in accordance with the requirements of the CONTRACT DOCUMENTS.

7.6 The ENGINEER and the ENGINEER'S representatives will at all times have access to the WORK. In addition, authorized representatives and agents of any participating Federal or State agency shall be permitted to inspect all work, materials, payrolls, records or personnel, invoices of materials, and other relevant data and records. The CONTRACTOR will provide proper facilities for such access and observation of the WORK and also for any inspection or testing thereof.

7.7 If any WORK is covered contrary to the written instruction of the ENGINEER, it must, if requested by the ENGINEER, be uncovered for the ENGINEER'S observation and replaced at the CONTRACTOR'S expense.

7.8 If the ENGINEER considers it necessary or advisable that covered WORK be inspected or tested by others, the CONTRACTOR, at the ENGINEER's request, will uncover, expose or otherwise make available for observation, inspection or testing as the ENGINEER may require, that portion of the WORK in question, furnishing all necessary labor, materials, tools, and equipment. If it is found that such WORK is defective, the CONTRACTOR will bear all the expenses of such uncovering, exposure, observation, inspection and testing, and of satisfactory reconstruction. If, however, such WORK is not found to be defective, the CONTRACTOR will be allowed an increase in the CONTRACT PRICE or an extension of the CONTRACT TIME, or both, directly attributable to such uncovering, exposure, observation, inspection, testing and reconstruction, and an appropriate CHANGE ORDER shall be issued.

8. SUBSTITUTIONS

8.1 Whenever a material, article, or piece of equipment is identified on the DRAWINGS or SPECIFICATIONS by reference to brand name or catalogue numbers, it shall be understood that this is the only acceptable product. In cases where two or more products are identified, then the CONTRACTOR may select from the products identified. Whenever a product is identified on the DRAWINGS or SPECIFICATIONS by reference to a brand name with "or approved equal" appended, then the CONTRACTOR may recommend the substitution of a material, article, or piece of equipment of equal substance and function for those referred to in the CONTRACT DOCUMENTS, and if, in the opinion of the ENGINEER, such material, article, or piece of equipment is of equal substance and function to that specified, the ENGINEER will allow its substitution and use by the CONTRACTOR. The CONTRACTOR will be required to identify selected items by brand name at the time of bidding. No substitutions will be allowed for these items, after the bids are opened.

9. PATENTS

9.1 The CONTRACTOR shall pay all applicable royalties and license fees, and shall defend all suits or claims for infringement of any patent rights and save the OWNERS harmless from loss in account thereof, except that the OWNERS shall be responsible for any such loss when a particular process, design, or product of a particular manufacturer or manufacturers is specified. However, if the CONTRACTOR has reason to believe that the design, process or products specified is an

infringement of a patent, the CONTRACTOR shall be responsible for such loss unless the CONTRACTOR promptly gives such information to the ENGINEER.

10. SURVEYS, PERMITS, REGULATIONS

10.1 The OWNERS shall furnish all boundary surveys and establish all base lines for locating the principal component parts of the WORK together with a suitable number of bench marks adjacent to the WORK as shown in the CONTRACT DOCUMENTS. From the information provided by the OWNERS, unless otherwise specified in the CONTRACT DOCUMENTS, the CONTRACTOR shall develop and make all detail surveys needed for construction such as slope stakes, batter boards, stakes for pipe locations and other working points, lines, elevations, and cut sheets.

10.2 The CONTRACTOR shall carefully preserve bench marks, reference points and stakes and, in case of willful or careless destruction, shall be charged with the resulting expense and shall be responsible for any mistake that may be caused by their unnecessary loss or disturbance.

10.3 Permits and licenses of a temporary nature necessary for the prosecution of the WORK shall be secured and paid for by the CONTRACTOR unless otherwise stated in the SUPPLEMENTAL GENERAL CONDITIONS. (These shall include City and/or County building permits, burn permits, debris disposal permits, etc.) Permits, licenses and easements for permanent structures or permanent changes in existing facilities shall be secured and paid for by the OWNERS, unless otherwise specified. The CONTRACTOR shall give all notices and comply with all laws, ordinances, rules and regulations bearing on the conduct of the WORK as drawn and specified. If the CONTRACTOR observes that the CONTRACT DOCUMENTS are at variance therewith, the CONTRACTOR shall promptly notify the ENGINEER in writing, and any necessary changes shall be adjusted as provided in Section 13, CHANGES IN THE WORK.

11. PROTECTION OF WORK, PROPERTY, AND PERSONS

11.1 The CONTRACTOR will be responsible for initiating, maintaining, and supervising all safety precautions and programs in connection with the WORK. The CONTRACTOR will take all necessary precautions for the safety of, and will provide the necessary protection to prevent damage, injury or loss to all employees on the WORK and other persons who may be affected thereby, all the WORK and all materials or equipment to be incorporated therein, whether in storage on or off the site, and other property at the site or adjacent thereto, including trees, shrubs, lawns, walks, pavements, roadways, structures and utilities not designated for removal, relocation or replacement in the course of construction.

11.2 The CONTRACTOR will comply with all applicable law, ordinances, rules, regulations, and orders of any public body having jurisdiction. The CONTRACTOR will erect and maintain, as required by the conditions and progress of the WORK, all necessary safeguards for safety and protection. The CONTRACTOR will notify OWNERS of adjacent utilities when prosecution of the WORK may affect them. The CONTRACTOR will remedy all damage, injury or loss to any property caused, directly or indirectly, in whole or part, by the CONTRACTOR, any SUBCONTRACTOR or anyone directly or indirectly employed by any of them or anyone of whose acts any of them may be liable, except damage or loss attributable to the fault of the CONTRACT DOCUMENTS or the acts

or omissions of the OWNERS, of the ENGINEER or anyone employed by either of them or anyone for whose acts either of them may be liable, and not attributable, directly or indirectly, in whole or in part, to the fault or negligence of the CONTRACTOR.

11.3 In emergencies affecting the safety of persons or the WORK or property at the site or adjacent thereto, the CONTRACTOR, without special instructions or authorization from the ENGINEER or OWNERS, shall act to prevent threatened damage, injury or loss. The CONTRACTOR will give the ENGINEER prompt WRITTEN NOTICE of any significant changes in the WORK or deviations from the CONTRACT DOCUMENTS caused thereby, and a CHANGE ORDER shall thereupon be issued covering the changes and deviations involved.

12. SUPERVISION BY CONTRACTOR

12.1 The CONTRACTOR will supervise and direct the WORK. He will be solely responsible for the means, methods, techniques, sequences and procedures of construction. The CONTRACTOR will employ and maintain on the WORK a qualified supervisor or superintendent who shall have been designated in writing by the CONTRACTOR as the CONTRACTOR'S representative at the site. The supervisor shall have full authority to act on behalf of the CONTRACTOR and all communications given to the supervisor shall be as binding as if given to the CONTRACTOR. The supervisor shall be present on the site at all times as required to perform adequate supervision and coordination of the WORK.

13. CHANGES IN THE WORK

13.1 The OWNERS may at any time, as the need arises, order changes within the scope of the WORK without invalidating the Agreement. If such changes increase or decrease the amount due under the CONTRACT DOCUMENTS, or in the time required for performance of the WORK, an equitable adjustment shall be authorized by CHANGE ORDER.

13.2 The ENGINEER, also, may at any time, by issuing a FIELD ORDER, make changes in the details of the WORK. The CONTRACTOR shall proceed with the performance of any changes in the WORK so ordered by the ENGINEER unless the CONTRACTOR believes that such FIELD ORDER entitles the CONTRACTOR to a change in CONTRACT PRICE or TIME, or both, in which event the CONTRACTOR shall give the ENGINEER WRITTEN NOTICE thereof within seven (7) days after the receipt of the ordered change. Thereafter the CONTRACTOR shall document the basis for the change in CONTRACT PRICE or TIME within thirty (30) days. The CONTRACTOR shall not execute such changes pending the receipt of an executed CHANGE ORDER or further instruction from the OWNERS.

14. CHANGES IN CONTRACT PRICE

14.1 The CONTRACT PRICE may be changed only by a CHANGE ORDER. The value of any WORK covered by a CHANGE ORDER or of any claim for increase or decrease in the CONTRACT PRICE shall be determined by one or more of the following methods in the order of precedence listed below:

- a. Unit prices contained in the bid schedule.
- b. An agreed lump sum.

15. TIME FOR COMPLETION AND LIQUIDATED DAMAGES

15.1 The date of beginning and the time for completion of the WORK are essential conditions of the CONTRACT DOCUMENTS and the WORK embraced shall be commenced on a date specified in the NOTICE TO PROCEED.

15.2 The CONTRACTOR will proceed with the WORK at such rate of progress to insure full completion within the CONTRACT TIME. It is expressly understood and agreed, by and between the CONTRACTOR and the OWNERS, that the CONTRACT TIME for the completion of the WORK described herein is a reasonable time, taking into consideration the average climatic and economic conditions and other factors prevailing in the locality of the WORK.

15.3 If the CONTRACTOR shall fail to complete the WORK within the CONTRACT TIME, or extension of time granted by the OWNERS, then the CONTRACTOR will pay to the OWNERS the amount for liquidated damages as specified in the Bid for each calendar day that the CONTRACTOR shall be in default after the time stipulated in the CONTRACT DOCUMENTS.

15.4 The CONTRACTOR shall not be charged with liquidated damages or any excess cost when the delay in completion of the WORK is due to the following and the CONTRACTOR has promptly given WRITTEN NOTICE of such delay to the OWNERS or ENGINEER.

15.4.1 To any preference, priority or allocation order duly issued by the OWNERS.

15.4.2 To unforeseeable causes beyond the control and without the fault or negligence of the CONTRACTOR, including but not restricted to, acts of God, or of the public enemy, acts of the OWNERS, acts of another CONTRACTOR in the performance of a contract with the OWNERS, fires, floods, epidemics, quarantine restrictions, strikes, freight embargoes, and abnormal and unforeseeable weather; and

15.4.3 To any delays of SUBCONTRACTORS occasioned by any of the causes specified in paragraphs 15.4.1 and 15.4.2 of this article.

16. CORRECTION OF WORK

16.1 The CONTRACTOR shall promptly remove from the premises all WORK rejected by the ENGINEER for failure to comply with the CONTRACT DOCUMENTS, whether incorporated in the construction or not, and the CONTRACTOR shall promptly replace and re-execute the WORK in accordance with the CONTRACT DOCUMENTS and without expense to the OWNERS and shall bear the expense of making good all WORK of other CONTRACTORS destroyed or damaged by such removal or replacement.

16.2 All removal and replacement WORK shall be done at the CONTRACTOR'S expense. If the CONTRACTOR does not take action to remove such rejected WORK within ten (10) days after receipt of WRITTEN NOTICE, the OWNERS may remove such WORK and store the materials at the expense of the CONTRACTOR.

17. SUBSURFACE CONDITIONS

17.1 The CONTRACTOR shall promptly, and before such conditions are disturbed, except in the event of an emergency, notify the OWNERS by WRITTEN NOTICE of:

17.1.1 Subsurface or latent physical conditions at the site differing materially from those indicated in the CONTRACT DOCUMENTS; or

17.1.2 Unknown physical conditions at the site, of an unusual nature, differing materially from those ordinarily encountered and generally recognized as inherent in WORK of the character provided for in the CONTRACT DOCUMENTS.

17.2 The OWNERS shall promptly investigate the conditions, and if it is found that such conditions do so materially differ and cause an increase or decrease in the cost of, or in the time required for, performance of the WORK, an equitable adjustment shall be made and the CONTRACT DOCUMENTS shall be modified by a CHANGE ORDER. Any claim of the CONTRACTOR for adjustment hereunder shall not be allowed unless the required WRITTEN NOTICE has been given; provided that the OWNERS may, if the OWNERS determines the facts so justify, consider and adjust any such claims asserted before the date of final payment.

18. SUSPENSION OF WORK, TERMINATION, AND DELAY

18.1 The OWNERS may suspend the WORK or any portion thereof for a period of not more than ninety days or such further time as agreed upon by the CONTRACTOR, by WRITTEN NOTICE to the CONTRACTOR and the ENGINEER which shall fix the date on which WORK shall be resumed.

The CONTRACTOR will resume that WORK on the date so fixed. The CONTRACTOR will be allowed an increase in the CONTRACT PRICE or an extension of the CONTRACT TIME, or both, directly attributable to any suspension.

18.2 If the CONTRACTOR is adjudged as bankrupt or insolvent, or makes a general assignment for the benefit of its creditors, or if a trustee or receiver is appointed for the CONTRACTOR or for any of its property, or if CONTRACTOR files a petition to take advantage of any debtor's act, or to reorganize under the bankruptcy or applicable laws, or repeatedly fails to supply sufficient skilled workmen or suitable materials or equipment, or repeatedly fails to make prompt payments to SUBCONTRACTORS or for labor, materials or equipment, or disregards laws, ordinances, rules, regulations or orders of any public body having jurisdiction of the WORK or disregards the authority of the ENGINEER, or otherwise violates any provision of the CONTRACT DOCUMENTS, then the OWNERS may, without prejudice to any other right or remedy and after giving the CONTRACTOR and its surety a minimum of ten (10) days from delivery of a WRITTEN NOTICE, terminate the services of the CONTRACTOR and take possession of the PROJECT and of all materials, equipment, tools, construction equipment and machinery thereon owned by the CONTRACTOR, and finish the

WORK by whatever method the OWNERS may deem expedient. In such case the CONTRACTOR shall not be entitled to receive any further payment until the WORK is finished. If the unpaid balance of the CONTRACT PRICE exceeds the direct and indirect costs of completing the project, including compensation for additional professional services, such excess SHALL BE PAID TO THE CONTRACTOR. If such costs exceed such unpaid balance, the CONTRACTOR will pay the difference to the OWNERS. Such costs incurred by the OWNERS will be determined by the ENGINEER and incorporated in a CHANGE ORDER.

18.3 Where the CONTRACTOR'S services have been so terminated by the OWNERS, said termination shall not affect any right of the OWNERS against the CONTRACTOR then existing or which may thereafter accrue. Any retention or payment of monies by the OWNERS due the CONTRACTOR will not release the CONTRACTOR from compliance with the CONTRACT DOCUMENTS.

18.4 After ten (10) days from delivery of a WRITTEN NOTICE to the CONTRACTOR and the ENGINEER, the OWNERS may, without cause and without prejudice to any other right or remedy, elect to abandon the PROJECT and terminate the CONTRACT. In such case the CONTRACTOR shall be paid for all WORK executed and any expense sustained plus reasonable profit.

18.5 If, through no act or fault of the CONTRACTOR, the WORK is suspended for a period of more than ninety (90) days by the OWNERS or under an order of court or other public authority, or the ENGINEER fails to act on any request for payment within thirty (30) days after it is submitted, or the OWNERS fails to pay the CONTRACTOR substantially the sum approved by the ENGINEER or awarded by arbitrators within thirty (30) days of its approval and presentation, then the CONTRACTOR may after ten (10) days from delivery of a WRITTEN NOTICE to the OWNERS and the ENGINEER terminate the CONTRACT and recover from the OWNERS payment for all WORK executed and all expenses sustained. In addition and in lieu of terminating the CONTRACT, if the ENGINEER has failed to act on a request for payment or if the OWNERS has failed to make any payment as aforesaid, the CONTRACTOR may upon ten (10) days written notice to the OWNERS and the ENGINEER stop the WORK until paid all amounts then due, in which event and upon resumption of the WORK CHANGE ORDERS shall be issued for adjusting the CONTRACT PRICE or extending the CONTRACT TIME or both to compensate for the costs and delays attributable to the stoppage of the WORK.

18.6 If the performance of all or any portion of the WORK is suspended, delayed, or interrupted as a result of a failure of the OWNERS or ENGINEER to act within the time specified in the CONTRACT DOCUMENTS, or if no time is specified, within a reasonable time, an adjustment in the CONTRACT PRICE or an extension of the CONTRACT TIME, or both, shall be made by CHANGE ORDER to compensate the CONTRACTOR for the costs and delays necessarily caused by the failure of the OWNERS or ENGINEER.

19. ASSIGNMENTS

19.1 Neither the CONTRACTOR nor the OWNERS shall sell, transfer, assign, or otherwise dispose of the Contract or any portion thereof, or of any right, title or interest therein, or any obligations thereunder, without written consent of the other party.

20. INDEMNIFICATION

20.1 The CONTRACTOR will indemnify and hold harmless the OWNERS and the ENGINEER and their agents and employees from and against all claims, damages, losses and expenses including attorney's fees arising out of or resulting from the performance of the WORK, provided that any such claims, damage, loss or expense is attributable to bodily injury, sickness, disease or death, or to injury to or destruction of tangible property including the loss of use resulting therefrom; and is caused in whole or in part by any negligent or willful act or omission of the CONTRACTOR, and SUBCONTRACTOR, anyone directly or indirectly employed by any of them or anyone for whose acts any of them may be liable.

20.2 In any and all claims against the OWNERS or the ENGINEER, or any of their agents or employees, by any employee of the CONTRACTOR, any SUBCONTRACTOR, anyone directly or indirectly employed by any of them, or anyone for whose acts any of them may be liable, the indemnification obligation shall not be limited in any way by any limitation on the amount or type of damages, compensation or benefits payable by or for the CONTRACTOR or any SUBCONTRACTOR under workmen's compensation acts, disability benefit acts or other employee benefits acts.

20.3 The obligation of the CONTRACTOR under this paragraph shall not extend to the liability of the ENGINEER, its agents or employees arising out of the preparation or approval of maps, DRAWINGS, opinions, reports, surveys, CHANGE ORDERS, designs or SPECIFICATIONS.

21. SEPARATE CONTRACTS

21.1 The OWNERS reserves the right to let other contracts in connection with this PROJECT. The CONTRACTOR shall afford other CONTRACTORS reasonable opportunity for the introduction and storage of their materials and the execution of their WORK, and shall properly connect and coordinate the WORK with theirs. If the proper execution or results of any part of the CONTRACTOR'S WORK depends upon the WORK of any other CONTRACTOR, the CONTRACTOR shall inspect and promptly report to the ENGINEER any defects in such WORK that render it unsuitable for such proper execution and results.

21.2 The OWNERS may perform additional WORK related to the PROJECT or the OWNERS may let other contracts containing provisions similar to these. The CONTRACTOR will afford the other CONTRACTORS who are parties to such Contracts (or the OWNERS, if the OWNERS is performing the additional WORK) reasonable opportunity for the introduction and storage of materials and equipment and the execution of WORK, and shall properly connect and coordinate the WORK with theirs.

21.3 If the performance of additional WORK by the CONTRACTORS or the OWNERS is not noted in the CONTRACT DOCUMENTS prior to the execution of the CONTRACT, written notice thereof shall be given to the CONTRACTOR prior to starting any such additional WORK. If the CONTRACTOR believes that the performance of such additional WORK by the OWNERS or others involves it in additional expense or entitles it to an extension of the CONTRACT TIME, the CONTRACTOR may make a claim thereof as provided in Sections 14 and 15.

22. SUBCONTRACTING

22.1 The CONTRACTOR may utilize the services of specialty SUBCONTRACTS on those parts of the WORK which, under normal contracting practices, are performed by specialty SUBCONTRACTORS.

22.2 The CONTRACTOR shall not award WORK to SUBCONTRACTOR(S), in excess of fifty (50%) percent of the CONTRACT PRICE, without prior written approval of the OWNERS.

22.3 The CONTRACTOR shall be fully responsible to the OWNERS for the acts and omissions of its SUBCONTRACTORS, and of persons either directly or indirectly employed by them, as the CONTRACTOR is for the acts and omissions of persons directly employed by it.

22.4 The CONTRACTOR shall cause appropriate provisions to be inserted in all subcontracts relative to the WORK to bind SUBCONTRACTORS to the CONTRACTOR by the terms of the CONTRACT DOCUMENTS insofar as applicable to the WORK of SUBCONTRACTORS and give the CONTRACTOR the same power as regards terminating any subcontract that the OWNERS may exercise over the CONTRACTOR under any provision of the CONTRACT DOCUMENTS.

22.5 Nothing contained in this CONTRACT shall create any contractual relation between any SUBCONTRACTOR and the OWNERS.

23. ENGINEER'S AUTHORITY

23.1 The ENGINEER shall act as the OWNERS' representative during the construction period, shall decide questions which may arise as to quality and acceptability of materials furnished and WORK performed, and shall interpret the intent of the CONTRACT DOCUMENTS in a fair and unbiased manner. The ENGINEER will make visits to the site and determine if the WORK is proceeding in accordance with the CONTRACT DOCUMENTS.

23.2 The CONTRACTOR will be held strictly to the intent of the CONTRACT DOCUMENTS in regard to the quality of materials, workmanship, and execution of the WORK. Inspections may be at the factory or fabrication plant of the source of material supply.

23.3 The ENGINEER will not be responsible for the construction means, controls, techniques, sequences, procedures, or construction safety.

23.4 The ENGINEER shall promptly make decisions relative to interpretation of the CONTRACT DOCUMENTS.

24. LAND AND RIGHTS-OF-WAY

24.1 Prior to issuance of NOTICE TO PROCEED, the OWNERS shall obtain all land and rights-of-way necessary for carrying out and for the completion of the WORK to be performed pursuant to the CONTRACT DOCUMENTS, unless otherwise mutually agreed.

24.2 The OWNERS shall provide to the CONTRACTOR information which delineates and describes the lands owned and rights-of-way acquired.

24.3 The CONTRACTOR shall provide at its own expense and without liability to the OWNERS any additional land and access thereto that the CONTRACTOR may desire for temporary construction facilities, or storage of materials.

25. GUARANTEE

25.1 The CONTRACTOR shall guarantee all materials and equipment furnished and WORK performed for a period of one year from the date of SUBSTANTIAL COMPLETION. The CONTRACTOR warrants and guarantees for a period of one (1) year from the date of SUBSTANTIAL COMPLETION of the system that the completed system is free from all defects due to faulty materials or workmanship and the CONTRACTOR shall promptly make such corrections as may be necessary by reason of such defects including the repairs of the damage of other parts of the system resulting from such defects. The OWNERS will give notice of observed defects with reasonable promptness. In the event that the CONTRACTOR should fail to make such repairs, adjustments, or other WORK that may be made necessary by such defects, the OWNERS may do so and charge the CONTRACTOR the cost thereby incurred. The Performance BOND shall remain in full force and effect through the guarantee period.

26. ARBITRATION

26.1 All claims, disputes, and other matters in question arising out of, or relating to, the CONTRACT DOCUMENTS or the breach thereof, except for claims which have been waived by making an acceptance of final payment as provided by Section 20, shall be decided by arbitration in accordance with the Construction Industry Arbitration Rules of the American Arbitration Association. This agreement to arbitrate shall be specifically enforceable under the prevailing arbitration law. The award rendered by the arbitrators shall be final, and judgment may be entered upon it in any court having jurisdiction thereof.

26.2 Notice of the demand for arbitration shall be filed in writing with the OWNERS party to the CONTRACT DOCUMENTS and with the American Arbitration Association and a copy shall be filed with the ENGINEER. Demand for arbitration shall in no event be made on any claim, dispute, or other matter in question which would be barred by the applicable statute of limitations.

26.3 The CONTRACTOR will carry on the WORK and maintain the progress schedule during any arbitration proceedings, unless otherwise mutually agreed in writing.

27. TAXES

27.1 The CONTRACTOR will pay all sales, consumer, use, and other similar taxes required by the laws of the place where the WORK is performed.

TECHNICAL SPECIFICATIONS FOR GLENDALE FIRE STATION SECTION 01030-ALTERNATES

PART 1 - GENERAL

Related Documents:

Drawings and general provisions of Contract, including General and Supplementary Conditions, apply to work of this section.

Description of Requirements:

Definition: An alternate is an amount proposed by Bidders and stated on the Bid Form that will be added to, deducted from, or substituted for an item in the Base Bid amount if the Owner decided to accept a corresponding change in either scope of work or in products, materials, equipment, systems or installation methods described in Contract Documents.

“Include as part of each alternate, miscellaneous devices, appurtenances and similar items incidental to or required for a complete installation whether or not mentioned as part of the alternate.”

Coordination: Coordinate related work and modify or adjust adjacent work as required to ensure that work affected by each accepted alternate is complete and fully integrated into the project.

**TECHNICAL SPECIFICATIONS FOR GLENDALE FIRE STATION
SECTION 01090-DEFINITIONS AND STANDARDS**

PART 1 - GENERAL

RELATED DOCUMENTS:

Drawings and general provisions of Contract, including General and Special Conditions, apply to work of this section.

DEFINITIONS:

GENERAL EXPLANATION: A substantial amount of specification language constitutes definitions for terms found in other contract documents, including drawings which must be recognized as diagrammatic in nature and not completely descriptive of requirements indicated thereon. Certain terms used in contract documents are defined generally in this article. Definitions and explanations of this section are not necessarily either complete or exclusive, but are general for the work extent not stated more explicitly in another provision of contract documents.

INDICATED: The term "Indicated" is a cross-reference to graphics, notes or schedules on drawings, to other paragraphs or schedules in the specifications, and to similar means of recording requirements in contract documents. Where terms such as "shown", "noted", "scheduled" and "specified" are used in lieu of "indicated", it is for purpose of helping reader locate cross-reference, and no limitation of location is intended except as specifically noted.

DIRECTED, REQUESTED, ETC.: Where not otherwise explained, terms such as "directed", "requested", "authorized", "selected", "approved", "required", "accepted", and "permitted" mean "directed by Engineer", "requested by Engineer", etc. However, no such implied meaning will be interpreted to extend Engineer's responsibility into Contractor's area of construction supervision.

APPROVE: Where used in conjunction with Engineer's response to submittals, requests, applications, inquiries, reports and claims by Contractor, the meaning of term "approved" will be held to limitations of Engineer's responsibilities and duties as specified in General and Special Conditions. In no case will "approval" by Engineer be interpreted as a release of Contractor from responsibilities to fulfill requirements of contract documents.

PROJECT SITE: The space available to Contractor for performance of the work, either exclusively or in conjunction with others performing other work as part of the project. The extent of project site is shown on drawings, and may or may not be identical with description of land upon which project is to be built.

FURNISH: Except as otherwise defined in greater detail, the term "furnish" is used to mean supply and deliver to project site, ready for unloading, unpacking, assembly, installation, etc., as applicable in each instance.

INSTALL: Except as otherwise defined in greater detail, term "install" is used to describe operations at project site including unloading, unpacking, assembly, erection, placing, anchoring, applying, working to dimension, finishing, curing, protecting, cleaning and similar operations, as applicable in each instance.

PROVIDE: Except as otherwise defined in greater detail, term "provide" means furnish and install, complete and ready for intended use, as applicable in each instance.

INSTALLER: The entity (person or firm) engaged by Contractor or its subcontractor or subcontractor for performance of a particular unit of work at project site, including installation, erection, application and similar required operations. It is a general requirement that such entities (Installers) be expert in operations they are engaged to perform.

TESTING LABORATORY: An independent entity engaged to perform specific inspections of tests of work, either at project site or elsewhere; and to report and (if required) interpret results of those inspections or tests.

SPECIFICATION EXPLANATIONS:

SPECIFICATION CONTENT: Because of methods by which this project specification has been produced, certain general characteristics of content, and conventions in use of language are explained as follows:

SPECIFYING METHODS: The techniques or methods of specifying to record requirements varies throughout text, and may include "prescriptive", "open generic-descriptive", "compliance with standards", "performance", "proprietary", or a combination of these. The method used for specifying one unit of work has no bearing on requirements for another unit of work.

OVERLAPPING AND CONFLICTING REQUIREMENTS: Where compliance with 2 or more industry standards or sets of requirements is specified, and overlapping of those different standards or requirements establishes different or conflicting minimums or levels of quality, most stringent requirement (which is generally recognized to be also most costly) is intended and will be enforced, unless specifically detailed language written into contract documents (not by way of reference to an industry standard) clearly indicates that a less stringent requirement is to be fulfilled. Refer apparently-equal-but-different requirements, and uncertainties as to which level of quality is the more stringent, to Engineer for a decision before proceeding.

CONTRACTOR'S OPTIONS: Except for overlapping or conflicting requirements, where more than one set of requirements are specified for a particular unit of work, option is intended to be Contractor's regardless of whether specifically indicated as such.

MINIMUM QUALITY/QUANTITY: In every instance, quality level or quantity shown or specified is intended as minimum for the work to be performed or provided. Except as otherwise specifically indicated, actual work may either comply exactly with that minimum (within specified tolerances), or may exceed that minimum within reasonable limits. In complying with requirements, indicated numeric values are either minimums or maximums as noted or as appropriate for context of requirements. Refer instances of uncertainty to Engineer for decision before proceeding.

SPECIALISTS; ASSIGNMENTS: In certain instances, specification text requires (or at least implies) that specific work be assigned to specialists or expert entities, who must be engaged for performance of those units of work. These must be recognized as special requirements over which Contractor has no choice or option. These assignments must not be confused with (and are not

intended to interfere with) normal application of regulations, union jurisdictions and similar conventions. One purpose of such assignments is to establish which party or entity involved in a specific unit of work is recognized as "expert" for indicated construction processes or operations. Nevertheless, final responsibility for fulfillment of entire set of requirements remains with Contractor.

TRADES: Except as otherwise indicated, the use of title such as "carpentry" in specification text, implies neither that the work must be performed by an accredited or unionized tradesperson or corresponding generic name (such as "carpenter"), nor that specified requirements apply exclusively to work by tradesperson of that corresponding generic name.

ABBREVIATIONS: The language of specifications and other contract documents is of the abbreviated type in certain instances, and implies words and meanings which will be appropriately interpreted. Actual work abbreviations of a self-explanatory nature have been included in texts. Specific abbreviations have been established, principally for lengthy technical terminology and primarily in conjunction with coordination of specification requirements with notations on drawings and in schedules. These are frequently defined in section at first instance of use. Trade association names and titles of general standards are frequently abbreviated. Singular words will be interpreted as singular where applicable and where full context of the contract documents so indicates.

INDUSTRY STANDARDS

GENERAL APPLICABILITY OF STANDARDS: Applicable standards of construction industry have same force and effect (and are made a part of contract documents by reference) as if copied directly into contract documents, or as if published copies were bound herewith.

Referenced standards (referenced directly in contract documents or by governing regulations) have precedence over non-referenced standards which are recognized in industry for applicability to work.

PUBLICATION DATES: Except as otherwise indicated, where compliance with an industry standard is required, comply with standard in effect as of date of contract documents.

COPIES OF STANDARDS: Provide where needed for proper performance of the work; obtain directly from publication sources.

ABBREVIATIONS AND NAMES: Where acronyms or abbreviations are used in specifications or other contract documents they are defined to mean the industry recognized name of trade association, standards generating organization, governing authority or other entity applicable to context of text provision. Refer to "Encyclopedia of Associations", published by Gale Research Co., available in large libraries.

SUBMITTALS

PERMITS, LICENSES AND CERTIFICATES: For the Owner's records, submit copies of permits, licenses, certificates, inspection reports, releases, jurisdictional settlements, notices, receipts for fee payments, judgments, and similar documents, correspondence and records

established in conjunction with compliance with standards and regulations bearing upon performance of the work.

PART 2 - PRODUCTS (Not Applicable)

PART 3 - EXECUTION (Not Applicable)

**TECHNICAL SPECIFICATIONS FOR GLENDALE FIRE STATION
SECTION 01155-SCHEDULES, REPORTS, PAYMENTS**

PART 1 - GENERAL

RELATED DOCUMENTS:

Drawings and general provisions of Contract, including General and Supplementary Conditions, apply to work of this section.

PRELIMINARY PROGRESS SCHEDULE:

BAR-CHART SCHEDULE: Not more than 7 days after date established for "commencement of the work", submit a bar-chart type progress schedule indicating a time bar for each major category or unit of work to be performed at site, properly sequenced and intermeshed, and showing completion of the work sufficiently in advance of date established for "substantial completion of the work".

PROGRESS MEETING:

INITIAL PROGRESS MEETING: Schedule initial progress meeting, recognized as "Pre-Construction Meeting", for a date not more than 15 days after date of commencement of the work. Use it as an organizational meeting, and review responsibilities and personnel assignments.

UNIT PRICE SCHEDULE:

GENERAL: Refer to individual specification sections for units of work where the establishment of unit prices is required. Methods of measurement and pricing are specified in these sections.

The Owner reserves the right to reject the Contractor's measurement of work-in-place which involves use of established unit prices, and to have this work measured by an independent surveyor acceptable to the Contractor at the Owner's expense.

PAYMENT REQUESTS:

WAIVERS OF LIEN: For final payment application, submit waiver of lien from every entity (including the Contractor) who could lawfully and possibly file a lien in excess of \$100 arising out of Contract and related to work covered by payment. Owner reserves right to designate which entities involved in the work must submit waivers.

FINAL PAYMENT APPLICATION: The administrative actions and submittals which must precede or coincide with submittal of final payment application can be summarized as follows, but not necessarily by way of limitation:

Completion of project closeout requirements.

Completion of items specified for completion beyond time of substantial completion (regardless of whether special payment application was previously made).

Assurance, satisfactory to Owner, that unsettled claims will be settled and that work not actually completed and accepted will be completed without undue delay.

Proof, satisfactory to Owner, that taxes, fees and similar obligations of Contractor have been paid.

Removal of temporary facilities, services, surplus materials, rubbish and similar provisions.

Consent of surety for final payment.

APPLICATION TRANSMITTAL: Submit 3 executed copies of each payment application.

PART 2 - PRODUCTS (Not Applicable)

PART 3 - EXECUTION (Not Applicable)

TECHNICAL SPECIFICATIONS FOR GLENDALE FIRE STATION

SECTION 01205-PROCEDURES AND CONTROLS

PART 1 - GENERAL

RELATED DOCUMENTS:

Drawings and general provisions of Contract, including General and Special Conditions, apply work of this section.

DESCRIPTION OF WORK:

The types of minimum requirements for procedures and performance of control work of a general nature include but are not necessarily limited to the following categories:

Administrative/Supervisory personnel.

Surveys and records or reports.

Trades people and workmanship standards.

Inspections, tests and reports.

General installation provisions.

Cleaning and protection.

Conservation and salvage.

ADMINISTRATIVE/SUPERVISORY PERSONNEL:

GENERAL: In addition to a General Superintendent and other administrative and supervisory personnel required for performance of the work, provide specific coordinating personnel as specified herein.

PROJECT COORDINATOR: Provide a full-time Project Coordinator, who is experienced in administration and supervision of construction including mechanical and electrical work, and who is hereby authorized to act as the general coordinator of interfaces between units of work. For purpose of these provisions, "interface" is defined to include the scheduling and sequencing of work, sharing of access to work spaces, installations, protection of each other's work, cutting and patching, tolerances, cleaning, selection for compatibility preparation of coordination drawings, inspections, tests, and temporary facilities and services.

SURVEYS AND RECORDS/REPORTS:

GENERAL: Working from lines and levels established by property survey, and as shown in relation to the other work, establish and maintain bench marks and other dependable markers to set lines and levels

for the work as needed to properly locate each element of entire project. Calculate and measure required dimensions as shown (within recognized tolerances if not otherwise indicated); do not scale drawings to determine dimensions. Advise tradesmen performing the work, of marked lines and levels provided for their use in layout work.

SURVEYOR: Engage a Land Surveyor or a Professional Engineer experienced and specializing in land survey work who is registered in State where project is located, to perform services specified in this article. Surveyor shall carry Professional Liability Insurance.

SURVEY PROCEDURES: Verify layout information shown on drawings, in relation to property survey and existing benchmarks, before proceeding with layout of actual work. Record deviations from required lines and levels, and advise Engineer promptly upon detection of deviations exceeding indicated or recognized tolerances. Record deviations which are accepted (not corrected) on record drawings.

TRADESPERSONS AND WORKMANSHIP STANDARDS:

GENERAL: Instigate and maintain procedures to ensure that persons performing work at site are skilled and knowledgeable in methods and craftsmanship needed to produce required quality-levels for workmanship in completed work. Remove and replace work that does not comply with workmanship standards as specified and as recognized in the construction industry for applications indicated. Remove and replace other work damaged or deteriorated by faulty workmanship or its replacement.

INSPECTIONS, TESTS AND REPORTS:

GENERAL: Required inspection and testing services are intended to assist in determination of probable compliances of work with requirements, but do not relieve Contractor of responsibility for those compliances, or for general fulfillment of requirements of contract documents. Specified inspections and tests are not intended to limit Contractor's quality control program. Afford reasonable access to agencies performing tests and inspections.

QUALIFICATION OF TESTING AGENCIES: Except as otherwise indicated and except where manufacturer's testing facilities are located as acceptable, engage independent testing laboratories specializing in required services.

REPORTS: Submit test/inspection reports, including agency's analysis of results and recommendations where applicable, in duplicate to Engineer except as otherwise indicated, and submit copies directly to governing authorities where required or requested.

Tests that will be required but are not limited to the following:

1. Field Density Tests,
2. Compressive Strength Test on Concrete, and
3. LBR's and proctors are required.

PART 2 - PRODUCTS (Not Applicable)

PART 3 - EXECUTION

MANUFACTURER'S INSTRUCTIONS

Where installations include manufactured products, comply with manufacturer's applicable instructions and recommendations for installation, to extent these are more explicit or more stringent than requirements indicated in contract documents.

Inspect each item of materials or equipment immediately prior to installation, and reject damaged and defective items.

Provide attachment and connection devices and methods for securing work properly as it is installed; true to line and level, and within recognized industry tolerances if not otherwise indicated. Allow for expansions and building movements. Provide uniform joint widths in exposed work, organized for best possible visual effect.

Recheck measurements and dimensions of the work, as an integral step of starting each installation.

Install work during conditions of temperature, humidity, exposure, forecasted weather, and status of project completion that will ensure best possible results for each unit of work, in coordination with entire work. Isolate each unit of work from non-compatible work, as required to prevent deterioration.

MOUNTING HEIGHTS: Where mounting heights are not indicated, mount individual units of work at industry-recognized standard mounting heights for applications indicated. Refer questionable mounting height choices to Engineer for final decision.

CLEANING AND PROTECTION

GENERAL: During handling and installation of work at project site clean and protect work in progress and adjoining work on a basis of perpetual maintenance. Apply suitable protective covering on newly installed work where reasonably required to ensure freedom from damage or deterioration at time of substantial completion; otherwise, clean and perform maintenance on newly installed work as frequently as necessary through remainder of construction period. Adjust and lubricate operable components to ensure operability without damaging effects.

LIMITING EXPOSURES OF WORK: To extent possible through reasonable control and protection methods, supervise performance of work in a manner and by means which will ensure that none of the work, whether completed or in progress, will be subjected to harmful dangerous, damaging, or otherwise deleterious exposures during construction period. Such exposures include (where applicable, but not by way of limitation) static loading, dynamic loading, internal pressures, external pressures, high or low temperatures, thermal shock, high or low humidity, air contamination or pollution, water, ice, solvents, chemicals, light, radiation, puncture, abrasion, heavy traffic, soiling, bacteria, insect infestation, combustion, electrical current, high speed operation, improper lubrication, unusual wear, misuse,

incompatible interface, destructive testing, misalignment, excessive weathering, unprotected storage, improper shipping/handling, theft and vandalism.

CONSERVATION AND SALVAGE

GENERAL: It is a general procedural requirement for supervision and administration of the work that construction operations be carried out with maximum practical consideration for conservation of energy, water and materials; and with maximum practical consideration for salvaging materials and equipment involved in performance of the work but not incorporated therein. Refer to other sections for required disposition of salvage materials and equipment that are Owner's property (change order procedures).

TECHNICAL SPECIFICATIONS FOR GLENDALE FIRE STATION SECTION 01340-SUBMITTALS

PART 1 - GENERAL

RELATED DOCUMENTS:

Drawings and general provisions of Contract, including General and Supplementary Conditions, apply to work of this section.

DESCRIPTION OF REQUIREMENTS:

The types of submittal requirements specified in this section include shop drawings, product data, samples and miscellaneous work-related submittals. Individual submittal requirements are specified in applicable sections for each unit of work. Refer to other sections and other contract documents for requirements of administrative submittals.

Definitions: Work-related submittals of this section are categorized for convenience as follows:

Shop drawings include specially-prepared technical data for this project, including drawings, diagrams, performance curves, data sheets, schedules, templates, patterns, reports, calculations, instructions, measurements and similar information not in standard printed form for general application to a range of similar projects.

Product data include standard printed information on materials, products and systems; not specially-prepared for this project, other than the designation of selections from among available choices printed therein.

Miscellaneous submittals related directly to the work (non-administrative) include warranties, maintenance agreements, workmanship bonds, project photographs, survey data and reports, physical work records, quality testing and certifying reports, copies of industry standards record drawings, field measurements data, operating and maintenance materials, overrun stock, and similar information, devices and materials applicable to the work and not processed as shop drawings, product data or samples.

SUBMITTAL REQUIREMENTS:

General: Except as otherwise indicated in individual work sections, comply with requirements specified herein for each indicated category of submittal. Provide and process intermediate submittals (where required between initial and final) similar to initial submittals.

Shop Drawings: Provide newly-prepared information with graphic information at accurate scale (except as otherwise indicated), with name of preparer indicated (firm name). Show dimensions and note which are based on field measurement. Identify materials and products in the work shown. Indicate compliance with standards, and special coordination requirements. Do not allow shop drawing copies without appropriate final approval markings by Engineer to be used in connection with the work. Submit five (5) copies of all shop drawings. The Engineer will maintain two (2) for his records, if more is needed by the Contractor, then the extra required number should be submitted.

Product Data: Collect required data into one submittal for each unit of work or system; and mark each copy to show which choices and options are applicable to project. Include manufacturer's standard printed recommendations for application and use, compliance with standards, application of labels and seals, rotation of field measurements which have been checked, and special coordination requirements. Maintain one set of product data (for each submittal) at project site, available for reference by Engineer or others.

Submittals: Do not submit product data or allow its use on project until compliance with requirements of contract documents has been confirmed by Contractor. Submittal is for information and record, unless otherwise indicated. Initial submittal is final submittal unless returned promptly by Engineer marked with "Revise and Resubmit" which indicates an observed non-compliance. Submit 3 copies, plus 2 additional copies (which will be returned) where required for maintenance manuals.

Warranties: Refer to Section 01605 - "Products" for specific general requirements on warranties, product/workmanship bonds, and maintenance agreements. In addition to copies desired for Contractor's use, furnish 3 executed copies, except furnish 2 additional (conformed) copies where required for maintenance manuals.

Closeout Submittals: Refer to individual work sections and to Section 01705 - "Closeout" for specific requirements on submittal of closeout information, materials, tools and similar items.

Maintenance/Operating Manuals: Furnish 5 bound copies.

Materials and Tools: Refer to individual work sections for required quantities of spare parts, extra and overrun stock, maintenance tools and devices, keys and similar physical units to be submitted.

ACTION OF SUBMITTAL:

Engineer's Action: Where action and return is required or requested, Engineer will review each submittal, mark with revise and resubmit, and where possible return within 2 weeks of receipt. Where submittal must be held for coordination, Contractor will be so advised by Engineer without delay.

Action Stamp: Engineer's action stamp, for use on submittals to be returned to Contractor, is self-explanatory as marked.

PART 2 - PRODUCTS (Not Applicable)

PART 3 - EXECUTION (Not Applicable)

TECHNICAL SPECIFICATIONS FOR GLENDALE FIRE STATION

SECTION 01605-PRODUCTS AND SUBSTITUTIONS

PART 1 - GENERAL

RELATED DOCUMENTS

Drawings and general provisions of Contract, including General and Special Conditions, apply to work of this section.

DESCRIPTION OF REQUIREMENTS

Definitions: "Products" is defined to include purchased items for incorporation into the work, regardless of whether specifically purchased for project or taken from Contractor's stock of previously purchased products. "Materials" is defined as products which must be substantially cut, shaped, worked, mixed, finished, refined or otherwise fabricated, processed, installed or applied to form units of work. "Equipment" is defined as products with operational parts, regardless of whether motorized or manually operated, and particularly including products with service connections (wiring, piping, etc.). Definitions in this paragraph are not intended to negate the meaning of the other terms used in contract documents, including "specialties", "systems", "structure", "finishes", "accessories", "furnishings", "special construction", and similar terms, which are self-explanatory and have recognized meanings in the construction industry.

Substitutions: The requirements for substitutions do not apply to specified Contractor options on products and construction methods. Revisions to contract documents, where requested by Owner or Engineer are "changes" not "substitutions". Requested substitutions during bidding period, which have been accepted prior to Contract Date, are included in contract document and are not subject to requirements for substitutions as specified herein. Contractor's determination of and compliance with governing regulations and orders issued by governing authorities do not constitute "substitutions"; and do not constitute a basis for change orders, except as provided for in contract documents. Otherwise, Contractors' requests for changes in products, materials and methods of construction required by contract documents are considered requests for "substitutions", and are subject to requirements hereof.

Standards: Refer to Section 01090 - "Definitions and Standards" for applicability of industry standards to products of project, and for acronyms used in text of specification sections.

QUALITY ASSURANCE

Source Limitations: To the greatest extent possible for each unit of work, provide products, materials or equipment of a singular generic kind and from a single source.

Compatibility of Options: Where more than one choice is available as options for Contractor's selection of a product or material, select an option that is compatible with other products and materials already selected (which may have been from among options for those other products and materials). Total compatibility among options is not assured by limitations within contract documents, but must be provided by Contractor. Compatibility is a basic general requirement of product/material selections.

SUBMITTALS

Requests for Substitutions: Submit 3 copies, fully identified for product or method being replaced by substitutions, including related specification section and drawing number(s), and fully documented to show compliance with requirements for substitutions. Include product data/drawings, description of methods, samples where applicable, Contractor's detailed comparison of significant qualities between specified item and proposed substitution, statement of effect on construction time and coordination with other affected work, cost information or proposal, and Contractor's statement to the effect that proposed substitution will result in overall work equal-to-or-better-than work originally indicated.

PRODUCT DELIVERY-STORAGE-HANDLING

General: Deliver, handle and store products in accordance with manufacturer's recommendations and by methods and means that will prevent damage, deterioration, and loss including theft. Control delivery schedules to minimize long-term storage of products at site and overcrowding of construction spaces. In particular, provide delivery/installation coordination to ensure minimum holding or storage times for products recognized to be flammable, hazardous, easily damaged, or sensitive to deterioration, theft, and other sources of loss.

WARRANTIES (GUARANTEES)

Coincidental Product Warranty: A warranty which is not specifically required by contract documents (other than as specified in this Section); but which is available on a product incorporated into the work, by virtue of the fact that manufacturer of product has published warranty in connection with purchases and uses of product without regard for specific applications except as otherwise limited by terms of warranty. Refer to individual sections of Division 2 through 16 for the determination of units of work that are required to be specifically or individually warranted, and for the specific requirements and terms of those warranties (or guarantees).

General Limitations: It is recognized that specific warranties are intended primarily to protect Owner against failure of the work to perform as required, and against deficient, defective and faulty materials and workmanship, regardless of sources. Except as otherwise indicated, specific warranties do not cover failures in the work which results from: 1) Unusual and abnormal phenomena of the elements, 2) The Owner's misuse, maltreatment or improper maintenance of the work, 3) Vandalism after time of substantial completion, of 4) Insurrection of acts of aggression including war.

Related Damages and Losses: In connection with Contractor's correction of warranted work which has failed, remove and replace other work of project which has been damaged as a result of such failure, or must be removed and replaced to provide access for correction of warranted work.

Reinstatement of Warranty Period: Except as otherwise indicated, when product warranty has failed and has been corrected by replacement or restoration, reinstate warranty by written endorsement for the following time period, starting on date of acceptance of replaced or restored work: a period of time equal to original warranty period of time.

Replacement Cost, Obligations: Except as otherwise indicated, costs of replacing or restoring failing warranted units or products is Contractor's obligation, without regard for whether Owner has already benefited from use through a portion of anticipated useful service lives.

PART 2 - PRODUCTS

GENERAL PRODUCT COMPLIANCES:

General: The compliance requirements, for individual products as indicated in contract documents, are multiple in nature and may include generic, descriptive, proprietary, performance, prescriptive, compliance with standards, compliance with codes, conformance with graphic details and other similar forms and methods of indicating requirements, all of which must be complied with. Also "allowances" and similar provisions of contract documents will have a bearing on selection process.

Procedures for Selecting Products: Contractor's options for selecting products are limited by contract document requirements, and governing regulations, and are not controlled by industry traditions or procedures experienced by Contractor on previous construction project. Required procedures include, but are not necessarily limited to, the following for various indicated methods of specifying:

Single Product/Manufacturer Name: Provide product indicated except advise Engineer before proceeding, where known that named product is not a feasible or acceptable selection.

Two or More Product/Manufacturer Names: Provide one of the named products, at Contractor's option; but excluding products which do not comply with requirements. Do not provide or offer to provide an unnamed product, except where none of named products comply with requirements or are a feasible selection; advise Engineer before proceeding.

"Or Equal": Where named products in specifications text are accompanied by the term "or equal", or other language of similar effect, comply with those contract document provisions concerning "substitutions" for obtaining Engineer's approval (by change order) to provide an unnamed product.

"Named": Except as otherwise indicated, is defined to mean manufacturer's name for product, as recorded in published product literature, of latest issue as of date of contract documents. Refer to requests to use products of a later (or earlier) model to Engineer for acceptance before proceeding.

Standards, Codes and Regulations: Where only compliance with an imposed standard, code or regulation is required, selection from among products which comply with requirements including those standards, codes and regulations, is Contractor's option.

Performance Requirements: Provide products that comply with specific performances indicated, and which are recommended by manufacturer (in published product literature or by individual certification) for application indicated. Overall performance of a product is implied where product is specified with only certain specific performance requirements.

Prescriptive Requirements: Provide products which have been produced in accordance with prescriptive requirements, using specified ingredients and components, and complying with specified requirements for mixing, fabricating, curing, finishing, testing and similar operations in manufacturing process.

SUBSTITUTIONS

Conditions: Contractor's request for substitution will be received and considered when extensive revisions to contract documents are not required and changes are in keeping with general intent of contract

documents; when timely, fully documented and properly submitted; and when one or more of following conditions is satisfied, all as judged by Engineer. Otherwise request will be returned without action except to record non-compliance with these requirements:

Where request is directly related to an "or equal" clause or other language of same effect in contract documents.

Where required product, material or method cannot be provided within Contract Time, but not as a result of Contractor's failure to pursue the work promptly to coordinate various activities properly.

Where required product, material or method cannot be provided in a manner which is compatible with other materials of the work, or cannot be properly coordinated, therewith, or cannot be warranted as required, or cannot be used without adversely affecting Owner's insurance coverage on completed work, or will encounter other substantial non-compliances which are not possible to otherwise overcome except by making requested substitution, which Contractor thereby certifies to overcome such non-compatibility, non-coordination, non-warranty, non-insurability or other non-compliance as claimed.

Where required product, material or method cannot receive required approval by a governing authority, and requested substitution can be so approved.

Where substantial advantage is offered Owner, in terms of cost, time, energy conservation or other valuable considerations, after deducting offsetting responsibilities Owner may be required to bear, including additional compensation to Engineer for redesign and evaluation services, increased cost of other work by Owner or separate contractors, and similar considerations.

Work Related Submittals: Contractor's submittal of, (and Engineer's acceptance of) shop drawings, product data or samples which indicated work not complying with requirements of contract documents, does not constitute an acceptable and valid request for, nor approval of, a substitution.

GENERAL PRODUCT REQUIREMENTS

General: Provide products which comply with requirements, and which are undamaged and unused at time of installation, and which are complete with accessories, trim, finish, safety guards and other devices and details needed for a complete installation and for intended use and effect.

Standard Products: Where available, provide standard products of types that have been produced and used previously and successfully on other projects and in similar applications.

Continued Availability: Where additional amounts of a product, by nature of its application, are likely to be needed by Owner at a later date for maintenance and repair or replacement work, provide a standard, domestically produced product which is likely to be available to Owner at such later date.

Equipment Nameplates: Provide permanent nameplate on each item of service-connected or power operated equipment. Indicate manufacturer, product name, model number, serial number, capacity, speed, ratings and similar essential operating data.

PART 3 - EXECUTION (Not Applicable)

TECHNICAL SPECIFICATIONS FOR GLENDALE FIRE STATION SECTION 01705-PROJECT CLOSEOUT

PART 1 - GENERAL

RELATED DOCUMENTS

Drawings and general provisions of Contract, including General and Supplementary Conditions, apply to work of this section.

DESCRIPTION OF REQUIREMENTS

Definitions: Closeout is hereby defined to include general requirements near the end of Contract Time, in preparation for final acceptance, final payment, normal termination of Contract, and similar actions evidencing completion of the work. Specific requirements for individual units of work are specified elsewhere in these specifications. Time of closeout is directly related to "Substantial Completion", and therefore may be either a single time period for entire work or a series of time periods for individual parts of the work that have been certified as substantially complete at different dates. That time variation (if any) shall be applicable to other provisions of this section.

PREREQUISITES FOR SUBSTANTIAL COMPLETION

General: Prior to requesting Engineer's inspection for certification of substantial completion (for either entire work or portions thereof), complete the following and list known exceptions in request:

In progress payment request, coincident with or first following date claimed, show either 100% completion for portion of work claimed as "substantially complete" or list incomplete items, value of incompleteness, and reasons for being incomplete.

Include supporting documentation for completion as indicated in these contract documents.

Submit statement showing accounting of changes to the Contract Sum.

Advise Owner of pending insurance changeover requirements.

Submit special warranties, workmanship/maintenance bonds, maintenance agreements, final certifications and similar documents.

Obtain and submit releases enabling Owner's full and unrestricted use of the work and access to services and utilities, including (where required) operating certificate, and similar releases.

Submit record drawings, maintenance manuals, and similar final record information.
Deliver tools, spare parts, extra stocks of materials, and similar physical items to Owner.

Make final changeover of locks and transmit keys to Owner, and advise Owner's personnel to changeover in security provisions.

Complete start-up testing of systems, and instructions of owner's operating/maintenance personnel. Discontinue (or change over) and remove from project site temporary facilities and services, along with construction tools and facilities, mock-ups, and similar elements.

Complete final cleaning up requirements, including touch-up painting of marred surfaces.

Touch-up and otherwise repair and restore marred exposed finishes.

Inspection Procedures: Upon receipt of Contractor's request, Engineer will either proceed with inspection or advise Contractor of prerequisites not fulfilled. Following initial inspection, Engineer will either prepare certificate of substantial completion, or advise Contractor of work which must be performed prior to issuance of certificate; and repeat inspection when requested and assured that work has been substantially completed. Results of completed inspection will form initial "punch-list" for final acceptance.

PREREQUISITES FOR FINAL ACCEPTANCE

General: Prior to requesting Engineer's final inspection for certification of final acceptance and final payment, as required by General Conditions, complete the following and list known exceptions (if any) in request:

Submit final payment request with final releases and supporting documentation not previously submitted and accepted. Include certificates of insurance for products and completed operations where required.

Submit updated final statement, accounting for additional (final) changes to the Contract Sum.

Submit consent of surety.

Submit final liquidation damages settlement statement, acceptable to Owner.

Revise and submit evidence of final continuing insurance coverage complying with insurance requirements.

Reinspection Procedure: Upon receipt of Contractor's notice that the work has been completed, including punch-list items resulting from earlier inspections, and accepting incomplete items delayed because of acceptable circumstances, Engineer will reinspect the work. Upon completion of reinspection, Engineer will either prepare certificate of final acceptance or advise Contractor of work not completed or obligations not fulfilled as required for final acceptance. If necessary, procedure will be repeated.

RECORD DOCUMENT SUBMITTALS:

General: Specific requirements for record documents are indicated in individual sections of these specifications. Other requirements are indicated in General Conditions. General submittal requirements are indicated in Section 01340 - "Submittals". Do not use record documents for construction purposes; protect from deterioration and loss in a secure fire-resistive location; provide access to record documents for Engineer's reference during normal working hours.

Record Drawings: Maintain a set of contract drawings and shop drawings in clean, undamaged condition, with mark-up of actual installations which vary substantially from the work as originally shown. Mark whichever drawing is most capable of showing "field" condition fully and accurately; however, where shop drawings are used for mark-up, record a cross-reference at corresponding location on working drawings. Mark with red erasable pencil and, where feasible, use other colors to distinguish between variations in separate categories of work. Mark-up new information that is recognized to be of importance to Owner, but was for some reason not shown on either the contract drawings or shop drawings. Give particular attention to concealed work, which would be difficult to measure and record at a later date. Note related change order numbers where applicable.

Record Specifications: Maintain one copy of specifications, including addenda, change orders and similar modifications issued in printed form during construction, and mark-up variation (of substance) in actual work in comparison with text of specifications and modifications as issued. Give particular attention to substitutions, selection of options, and similar information on work where it is concealed or cannot otherwise be readily discerned at a latter date by direct observation. Note related record drawing information and product data, where applicable. Upon completion of mark-up, submit to Engineer for Owner's records.

Maintenance Manuals: Organize maintenance-and-operating manual information into suitable sets of manageable size, and bind into individual binders properly identified and indexed (thumb tabbed). Four (4) sets will be required. Include emergency instructions, spare parts listing, copies of warranties, wiring diagrams, recommended "turn-around" cycles, inspection procedures, shop drawings, product data, and similar applicable information.

PART 2 - PRODUCTS (Not Applicable)

PART 3 - EXECUTION

CLOSEOUT PROCEDURES

General Operating/Maintenance Instructions: Arrange for each installer of work requiring continuing maintenance or operating to meet with Owner's personnel, at project site, to provide basic instructions needed for proper operation and maintenance of entire work. Include instructions by manufacturer's representatives where installers are not experts in the required procedures. Review maintenance manuals, record documentation, tools, spare parts and materials, lubricants, fuels, identification systems, control sequences, hazards, cleaning and similar procedures and facilities. For operational equipment, demonstrate start-up, shutdown, emergency operations, noise and vibration adjustments, safety, economy/efficiency adjustments, energy effectiveness, and similar operations. Review maintenance and operations in relation with applicable warranties, agreements to maintain, bonds and similar continuing commitments.

FINAL CLEANING

General: Special cleaning for specific units of work is specified in other sections. The following are examples, but not by way of limitation, of cleaning levels required:

Remove labels that are not required as permanent labels.

Wipe surfaces of mechanical and electrical equipment clean and remove excess lubrication and other substances.

Clean project site (yard and grounds), including landscape development areas, of litter and foreign substances. Sweep paved areas to a broom-clean condition; remove stains, petro-chemical spills and other foreign deposits. Rake grounds that are neither planted nor paved, to a smooth, even-textured surface.

Compliances: Comply with safety standards and governing regulations for cleaning operations. Do not burn waste materials at site, or bury debris or excess materials on Owner's property, or discharge volatile or other harmful or dangerous materials into drainage systems; remove waste materials from site and dispose of in a lawful manner.

Where extra materials of value remaining after completion of the associated work have become the Owner's property, dispose of these to Owner's best advantage as directed.

TECHNICAL SPECIFICATIONS FOR GLENDALE FIRE STATION SECTION 01800-RIPRAP

SUBGRADE PREPARATION

The subgrade surfaces on which the rock riprap, filter or bedding is to be placed shall be cut or filled and graded to the lines and grades shown on the drawings. When fill to subgrade lines is required, it shall consist of approved materials and shall conform to the requirements of the specified class of fill.

Rock riprap, filter or bedding shall not be placed until the foundation preparation is completed and the subgrade surfaces have been inspected and approved by the Engineer.

MATERIALS

CLASS 2 RIPRAP

Riprap shall be durable stone with a minimum unit weight of 165 pounds per cubic foot. Riprap gradation shall conform to the requirements of Class 2 riprap, Alabama Highway Department Standard specification for Highway Construction, section 814 (current edition). Stone for Class 2 riprap shall consist of reasonably well-graded durable rock with a median stone size of 80 pounds and not over 10 percent larger than 200 pounds. There shall be sufficient small stones and spalls to approximately fill the void between the larger stones.

METHOD OF MEASUREMENT AND PAYMENT

For items of work for which specific unit prices are established in the contract, the quantity of all riprap placed within the specified limits will be measured to the nearest square yard by actual areas (field measurement). The Engineer of Record at random locations shall verify the specified thickness of 24 inches during construction inspection and prior to approval of payment application. Truck tickets may be requested by the Engineer of Record for verification purposes, however the actual payment will be based on the unit prices that were included in the bidding schedule as square yards at a thickness of 18 inches and shall include all materials, hauling, excavation, and backfill required to complete the project as shown in the plans. There will be no payment based upon the TONS of riprap hauled to the project site during construction.

ITEMS OF WORK AND CONSTRUCTION DETAILS

This item shall consist of furnishing and installing the loose riprap to the neat lines and grades as shown on the drawings.

Any incidental shaping required preparing the foundation for rock placement and backfill around the completed installation shall be considered as included in this item.

Riprap may be equipment placed with handwork to fill voids and provide uniformity. Hand placement of the rock will be required where adjacent to the pipes and sand cement bag riprap.

Written material certification for the rock riprap will not be required unless there is reasonable doubt that the item proposed for use meets the requirements of this specification.

**TECHNICAL SPECIFICATIONS FOR GLENDALE FIRE STATION
SECTION 02110-SITE CLEARING**

PART 1 - GENERAL

RELATED DOCUMENTS:

Drawings and general provisions of Contract, including General and Special Conditions, apply to work of this section.

DESCRIPTION OF WORK:

Extent of site clearing is shown on drawings.

Site clearing work includes, but is not limited to:

Protection of existing trees.

Removal of trees and other vegetation.

Topsoil stripping.

Clearing and grubbing.

Removing above-grade improvements.

Removing below-grade improvements.

JOB CONDITIONS:

Traffic: Conduct site clearing operations to ensure minimum interference with roads, streets, walks, and other adjacent occupied or used facilities. Do not close or obstruct streets, walks or other occupied or used facilities without permission from authorities having jurisdiction.

Protection of Existing Improvements: Provide protection necessary to prevent damage to existing improvements indicated to remain in place.

Protection improvements on adjoining properties and on Owner's property.

Restore damaged improvements to their original condition, as acceptable to parties having jurisdiction.

Protection of Existing Trees and Vegetation: Protect existing trees and other vegetation indicated to remain in place, against unnecessary cutting, breaking or skinning of roots, skinning and bruising of bark, smothering of trees by stockpiling construction materials or excavated materials within drip

line, excess foot or vehicular traffic, or parking of vehicles within drip line. Provide temporary guards to protect trees and vegetation to be left standing.

Salvable Improvements: Carefully remove items indicated to be salvaged, and store on Owner's premises where indicated or directed.

PART 2 - PRODUCTS

Not applicable

PART 3 - EXECUTION

SITE CLEARING:

General: Remove trees, shrubs, grass and other vegetation, improvements, or obstructions interfering with installation of new construction. Remove such items elsewhere on the site or premises as specifically indicated. Removal includes digging out stumps and roots.

Carefully and cleanly cut roots and branches of trees indicated to be left standing, where such roots and branches obstruct new construction.

Topsoil: Topsoil is defined as friable clay loam surface soil found in a depth of not less than 4". Satisfactory topsoil is reasonably free of topsoil, clay lumps, stones, and other objects over 2" in diameter, and without weeds, roots, and other objectionable material.

Remove heavy growths of grass from areas before stripping.

Where trees are indicated to be left standing, stop topsoil stripping a sufficient distance to prevent damage to main root system.

Stockpile topsoil in storage piles in areas shown, or where directed. Construct storage piles to freely drain surface water. Cover storage piles if required to prevent wind-blown dust.

Dispose of unsuitable or excess topsoil same as waste material, herein specified.

Clearing and Grubbing: Clear site of trees, shrubs and other vegetation, except for those indicated to be left standing.

Completely remove stumps, roots, and other debris protruding through the ground surface.

Use only hand methods for grubbing inside drip line of trees indicated to be left standing.

Fill depressions caused by clearing and grubbing operations with satisfactory soil material, unless further excavation or earthwork is indicated.

Place fill material in horizontal layers not exceeding 6" loose depth, and thoroughly compact to a density equal to adjacent original ground.

Removal of Improvements: Remove existing above-grade and below-grade improvements necessary to permit construction, and other work as indicated.

DISPOSAL OF WASTE MATERIALS:

Burning on Owner's Property: Burning is not permitted on Owner's property unless Owner's approval is obtained and proper authorities are notified.

Removal from Owner's Property: Remove waste materials and unsuitable materials from Owner's property and dispose of off site in legal manner.

TECHNICAL SPECIFICATIONS FOR GLENDALE FIRE STATION

SECTION 02200-EARTHWORK

PART 1 - GENERAL

RELATED DOCUMENTS:

Drawings and general provisions of Contract apply to work of this section.

DESCRIPTION OF WORK:

Definition: "Excavation" consists of removal of material encountered to subgrade elevations indicated and subsequent disposal of materials removed.

QUALITY ASSURANCE:

Codes and Standards: Perform excavation work in compliance with applicable requirements of governing authorities having jurisdiction.

Testing and Inspection Service: Employ, at Contractor's expense, a testing laboratory subject to approval by the Engineer to perform soil testing and inspection service for quality control during earthwork operations.

SUBMITTALS:

Test Reports-Excavating: Submit following reports directly to Engineer from the testing services with copy to Contractor:

- Test reports on fill material. (Modified Proctor Tests)
- Field density test reports. (Percent Compaction and Moisture Content)
- LBR's for Sub-grade and base materials.

JOB CONDITIONS:

Existing Utilities: Locate existing underground utilities in areas of work. If utilities are to remain in place, provide adequate means of support and protection during earthwork operations.

- Should uncharted, or incorrectly charted, piping or other utilities be encountered during excavation, consult utility owner immediately for directions. Cooperate with Owner and utility companies in keeping respective services and facilities in operation. Contractor shall bear all costs of repairing damaged utilities to the satisfaction of utility owner.

- Do not interrupt existing utilities serving facilities occupied and used by Owner or others, during occupied hours, except when permitted in writing by Engineer and then only after acceptable temporary utility services have been provided.
- Provide minimum of 48-hour notice to engineer, and receive notice to proceed before interrupting any utility.
- Demolish and completely remove from site existing underground utilities indicated to be removed. Coordinate with utility companies for shut-off of services if lines are active.

Use of explosives: The use of explosives is not permitted.

Protection of Persons and Property: Barricade open excavations occurring as part of this work and post with warning lights.

- Operate warning lights as recommended by authorities having jurisdiction.
- Protect structures, utilities, sidewalks, pavements, and other facilities from damages caused by settlement, lateral movement, undermining, washout, and other hazards created by earthwork operations.
- Perform excavation within drip-line of large trees to remain by hand, and protect the root system from damage or dry out in the manner prescribed in Division 2 specification sections.

PART 2 - PRODUCTS

SOILS MATERIALS:

Subbase Material: Naturally or artificially graded mixture of natural or crushed gravel, crushed stone, crushed slag, natural or crushed sand.

Backfill and Fill Materials: Satisfactory soil materials free of clay, rock or gravel larger than 2" in any dimension, debris, waste, frozen materials, vegetable and other deleterious matter. The fill material should be sand containing little fines. Prior to placing the fill material, the existing material shall be stripped of all soils containing a significant percentage of organics and all loose soils which cannot be readily compacted. If existing materials do not meet these requirements, it may be necessary to backfill with select materials other than those on the job site.

PART 3 - EXECUTION/GENERAL INSTRUCTIONS:

EXCAVATION:

Excavation is Unclassified, and includes excavation to subgrade elevations indicated, regardless of character of materials and obstructions encountered.

Unauthorized excavation consists of removal of materials beyond indicated subgrade elevations or dimensions without specific direction of Engineer. Unauthorized excavation, as well as remedial work directed by Engineer, shall be at Contractor's expense.

Under footings, foundation bases, or retaining walls, fill unauthorized excavation by extending indicated bottom of elevation of footing or base to excavation bottom, without altering required top elevation. Lean concrete fill may be used to bring elevations to proper position, when acceptable to Engineer.

Elsewhere, backfill and compact unauthorized excavations as specified for authorized excavations of same classifications, unless otherwise directed by engineer.

- Additional Excavation: When excavation has reached required subgrade elevations, notify Engineer who will make an inspection of conditions.
 1. If unsuitable bearing materials are encountered at required subgrade elevations, notify Engineer who will make an inspection of conditions.
 2. If unsuitable bearing materials are encountered at required subgrade elevations, carry excavations deeper and replace excavated material as directed by the Engineer.
 3. Removal of unsuitable material and its replacement as directed will be paid on basis of contract conditions relative to changes in work.

- Stability of Excavations: Slope sides of excavations to comply with local codes and ordinances having jurisdiction. Shore and brace where sloping is not possible because of space restrictions or stability of material excavated.
 1. Maintain sides and slopes of excavations in safe condition until completion of backfilling.
 2. Shoring and Bracing: Provide materials for shoring and bracing, such as sheet piling, uprights, stringers and cross-braces, in good serviceable condition.
 3. Establish requirements for trench shoring and bracing to comply with local codes and authorities having jurisdiction.
 4. Maintain shoring and bracing in excavations regardless of time period excavations will be open. Carry down shoring and bracing as excavation progresses.

- Dewatering: Prevent surface water and subsurface or ground water from flowing into excavations and from flooding project site and surrounding area. The cost of all dewatering operations including well pointing shall be the responsibility of the Contractor.

1. Do not allow water to accumulate in excavations. Remove water to prevent softening of foundation bottoms, undercutting footings, and soil changes detrimental to stability of subgrades and foundations. Provide and maintain pumps, well points, sumps, suction and discharge lines, and other dewatering system components necessary to convey water away from excavations.
 2. Establish and maintain temporary drainage ditches and other diversions outside excavation limits to convey rain water and water removed from excavations to collecting or run-off areas. Do not use trench excavations as temporary drainage ditches.
- Material Storage: Stockpile satisfactory excavated materials where directed, until required for backfill or fill. Place, grade, and shape stockpiles for proper drainage.
 1. Locate and retain soil materials away from edge of excavations. Do not store within drip line of trees indicated to remain.
 2. Dispose of excess soil material and waste materials as herein specified.
 - Excavation for Structures: Conform to elevations and dimensions shown within a tolerance of plus or minus 0.10', and extending a sufficient distance from footings and foundations to permit placing and removal of concrete formwork, installation of service, other construction, and for inspection.
 1. In excavating for footings and foundations, take care not to disturb bottom of excavation. Excavate by hand to final grade just before concrete reinforcement is placed. Trim bottoms to required lines and grades to leave solid base to receive other work.
 - Excavation for Trenches: Dig trenches to the uniform width required for particular item to be installed, sufficiently wide to provide ample working room. Provide 6" to 9" clearance on both sides of pipe or conduit and a maximum of 30" total width.
 1. Excavate trenches to depth indicated or required. Carry depth of trenches for piping to establish indicated flow lines and invert elevations. Beyond building perimeter, keep bottoms of trenches sufficiently below finish grade to avoid freeze-ups.
 2. Where rock is encountered, carry excavation 6" below required elevation and backfill with a 6" layer of crushed stone or gravel prior to installation of pipe.
 3. For pipes or conduit 5" or less in nominal size and for flat-bottomed multiple-conduit conduit units, do not excavate beyond indicated depths. Hand excavate bottom cuts to accurate elevations and support pipe or conduit on undisturbed soil.
 4. For pipes or conduit 6" or larger in nominal size, tanks and other mechanical/electrical work indicated to receive subbase, excavate to subbase

depth indicated, or, if not otherwise indicated, to 6" below bottom of work to be supported.

5. Except as otherwise indicated, excavate for waterbearing piping so top of piping is not less than 3'-0" below finished pavement grade, but no less than 2'-6" below finish grade.
6. Grade bottoms of trenches as indicated, notching under pipe bells to provide solid bearing for entire body of pipe.
7. Backfill trenches with concrete where trench excavations pass within 18" of column or wall footings and which are carried below bottom of such footings, or which pass under wall footings. Place concrete to level of bottom of adjacent footing.
8. Use care in backfilling to avoid damage or displacement of pipe systems.

COMPACTION:

- General: Control soil compaction during construction, providing minimum percentage of density specified for each area classification indicated below.
 1. All compaction requirements for this section are specified on the construction plans.
- Moisture Control: Where subgrade of layer of soil material must be moisture conditioned before compaction, uniformly apply water to surface of subgrade, or layer of soil material, to prevent free water appearing on surface during subsequent to compaction operations.
 1. Remove and replace, or scarify and air dry, soil material that is too wet to permit compaction to specified density.
 2. Soil material that has been removed because it is too wet to permit compaction may be stockpiled or spread and allowed to dry. Assist drying by dicing, harrowing or pulverizing, until moisture content is reduced to a satisfactory value.

BACKFILL AND FILL:

- General: Place acceptable soil material in layers to required subgrade elevations, for each area classification listed below:
 1. In excavations, use satisfactory excavated or borrow material.
 2. Under grassed areas, use satisfactory excavated or borrow material.

3. Under walks and pavements, use subbase material, or satisfactory excavated or borrow material, or combination of both.
 4. Under piping and conduit, use subbase material where subbase is indicated under piping or conduit; shape to fit bottom 90 degrees of cylinder.
- Backfill excavation as promptly as work permits, but not until completion of the following;
 1. Acceptance of construction below finish grade.
 2. Inspection, testing, approval, and recording locations of underground utilities.
 3. Removal of concrete formwork.
 4. Removal of shoring and bracing, and backfilling of voids with satisfactory materials. Cut off temporary sheet piling driven below bottom of structures and remove in manner to prevent settlement of the structure or utilities, or leave in place if required.
 5. Removal of trash and debris.
 6. Permanent or temporary horizontal bracing is in place on horizontally supported walls.
 - Ground Surface Preparation: Remove vegetation, debris, unsatisfactory soil materials, obstructions, and deleterious materials from ground surface prior to placement of fills. Plow, strip, or break-up sloped surfaces steeper than 1 vertical to 4 horizontal so that fill material will bond with existing surface.
 1. When existing ground surface has a density less than that specified under "Compaction" for particular area classification, break-up ground surface, pulverize, moisture-condition to optimum moisture content, and compact to required depth and percentage of maximum density.
 - Placement and Compaction: The lower portion of backfill, to a compacted level of one foot above the top of the pipe, shall be hand placed in layers of lifts not to exceed six inches of compacted depth and each layer compacted individually by means of hand tampers. Above that level, place lifts in layers not to exceed twelve inches of compacted depth and machine filling and tamping may be used.
 1. Before compaction, moisten or aerate each layer as necessary to provide optimum moisture content. Compact each lift to required percentage of minimum soil density for each area classification as designated herein. Do not place backfill or fill material on surfaces that are muddy, frozen, or contain frost or ice.

2. Place backfill and fill materials evenly adjacent to structures, piping or conduit to required elevations. Take care to prevent wedging action of backfill against structures or displacement of piping or conduit by carrying material uniformly around structure, piping or conduit to approximately same elevation in each lift.

GRADING:

- General: Uniformly grade areas within limits of grading under this section, including adjacent transition areas. Smooth finished surfaces within specified tolerances, compact with uniform levels or slopes between points where elevations are indicated, or between such points and existing grades.
- Grading Outside Building Lines: Grade areas adjacent to building lines to drain away from structures and to prevent ponding.
- Finish surfaces free from irregular surface changes, and as follows:
 1. Lawn or Unpaved Areas: Finish areas to receive topsoil to within not more than 0.10' above or below required subgrade elevations.
 2. Walks: Shape surface of areas under walks to line, grade and cross-section, with finish surface not more than 0.10' above or below required subgrade elevation.
 3. Pavements: Shape surface of areas under pavement to line, grade and cross-section, with finish surface not more than 1/2" above or below required subgrade elevations.
 4. Grading Surface of Fill Under Building Slabs: Grade smooth and even, free from voids, compacted as specified, and to required elevation.
 5. Provide final grades within a tolerance of 1/2" when tested with a 10' straightedge.
 6. Compaction: After grading, compact subgrade surfaces to the depth and indicated percentage for each area classification.

FIELD QUALITY CONTROL:

- Quality Control Testing During Construction: Provide testing service by a qualified soil testing firm, subject to Engineer's approval, to inspect and approve subgrades and fill layers before further construction work is performed.

- Paved Areas: Make at least one field density test of subgrade for every 1,000 square feet of paved area per lift (1 test per 50 LF on 20 roadway). In each compacted fill layer, make one field density test for every 2,000 square feet of paved area per lift.
- Non-Paved Areas: Perform at least 1 field density test per 1,000 square feet of fill per every vertical foot of height (1 test per 50 LF on 20 roadway), and perform at least 1 field density test per 20 LF of pipe installed per every 2 feet of vertical trench depth.
- Provide LBR test results on type B stabilized subgrade with a frequency of one (1) test per 1,000 LF of roadway.
- Provide LBR test results on base material at a frequency of 1 LBR per 500 CY of material placed.

If in opinion of Engineer, based on testing service reports and inspection, subgrade or fills which have been placed below are specified density, provide additional compaction and testing at no additional expense.

TECHNICAL SPECIFICATIONS FOR GLENDALE FIRE STATION

SECTION 02210-GRASSING

PART 1 - GENERAL

RELATED DOCUMENTS:

Drawings and general provisions of Contract, including General and Special Conditions, apply to work of this section.

DESCRIPTION OF WORK:

All disturbed areas throughout the project that are not specifically designated as being sodded on the plans shall be seeded.

QUALITY ASSURANCE:

All seed used shall be labeled in accordance with U. S. Department of Agriculture Rules and Regulations under the Federal Seed Act in effect on the date of invitation for bids. All seed shall be furnished in sealed standard containers, unless exception is granted in writing by Owner. Seed which has become wet, moldy, or otherwise damaged in transit or in storage shall not be used. Fertilizer shall be delivered to the site in the original, unopened containers, each bearing the manufacturer's guaranteed analysis. Any fertilizer which becomes caked or otherwise damaged, making it unsuitable for use, shall not be used. Seed, fertilizer and other grassing materials shall be stored under cover and protected from damage which would make them unacceptable for use.

SUBMITTALS:

Approvals, except those required for field installations, field applications, and field tests shall be obtained before delivery of materials or equipment to the project. The results of laboratory tests performed on the topsoil material shall be submitted. The reports shall include the pH level, the amount of organic matter, and available phosphoric acid and potash of the soil intended for use in the work. Certificate of conformance will be required for the following:

1. Grass seed shall be certified by registered, certified seed association or a registered testing laboratory not more than ten months prior to seeding.
2. Sprigs
3. Fertilizer
4. Topsoil
5. Lime
6. Mulching

PART 2 - PRODUCTS

TOPSOIL:

If the quantity of existing stored or excavated topsoil is inadequate for planting, sufficient additional topsoil shall be furnished. Topsoil furnished shall be a natural, fertile, friable soil, possessing characteristics of representative productive soils in the vicinity. It shall be obtained from naturally well-drained areas. Topsoil shall be without admixture of subsoil and free from johnson grass (*Sorghum halepense*), nut grass (*Cyperus rotundus*) and objectionable weeds and toxic substances.

SOIL AMENDMENTS:

Lime: Ground Limestone (Dolomite) containing not less than 85 percent of total carbonates, and shall be ground to such a fineness that 50 percent will pass a 100-mesh sieve and 90 percent will pass a 20-mesh sieve.

Fertilizer: 16-16-16 formulation of which 60 percent of the nitrogen is in the urea-formaldehyde form and shall conform to the applicable State Fertilizer laws. It shall be granulated so that 80 percent is held on a 16-mesh screen, uniform in composition, dry and free-flowing.

Mulch: Clean hay, fresh straw mulch or wood chips.

GRASS MATERIALS:

Grass Seed: Federal Specifications JJJ-S-181 and shall satisfy the following requirements:

| <u>Seed</u> | <u>Min. % Pure Seed</u> | <u>Min.% Germination and Hard Seed</u> | <u>Max. % Weed Seed</u> |
|--|-----------------------------|--|-----------------------------|
| Argentine Bahia (<i>Paspalum notatum</i>) | 80% | 65% 15% | .25% |

Seed failing to meet the purity or germination requirements by no more than twenty-five percent may be used, but the quantity shall be increased to yield the required rate of pure live seed. Seed failing to meet the weed seed requirements shall not be used.

PART 3 - EXECUTION

GRADING:

Areas to be grassed shall be graded to remove depressions, undulations, and irregularities in the surface before grassing.

PLACING TOPSOIL:

Areas to be grassed shall have a minimum topsoil cover of two inches. Topsoil shall not be placed when the subgrade is excessively wet, extremely dry or in a condition otherwise detrimental to the proposed planting or proper grading.

TILLAGE:

The area to be grassed shall be thoroughly tilled to a depth of four inches using a plow and disc harrow or rotary tilling machinery until a suitable bed has been prepared and no clods or clumps remain larger than 1-1/2 inches in diameter.

APPLICATION OF LIME:

The pH of the soil shall be determined. If the pH is below 5.0, sufficient lime shall be added to provide a pH between 5.5 and 6.5. The lime shall be thoroughly incorporated into the top three to four inches of the soil. Lime and fertilizer may be applied in one operation.

APPLICATION OF FERTILIZER:

Fertilizer shall be applied at the rate of 6 pounds per 1,000 square feet and shall be thoroughly incorporated into the top three to four inches of soil.

PLANTING SOIL:

All areas disturbed during construction shall be seeded as specified herein. Immediately before seeds are sown and after fertilizer and lime are applied, the ground shall be scarified as necessary and shall be raked until the surface is smooth, friable, and of uniformly fine texture. Areas to be grassed shall be seeded evenly with a mechanical spreader, raked lightly, rolled with a 200-pound roller, and watered with a fine spray.

- 1. Seed shall be applied at the following rate:

| <u>Seed</u> | <u>Rate of Application</u> |
|-----------------------|----------------------------|
| Argentine Bahia Grass | 6lbs./1,000 sq. ft. |

(Paspalum notatum)

260 lbs./acre

2. Seeded areas shall be mulched at the rate of not less than 1-1/2" loose measurement over all seeded areas. Spread by hand, blower, or other suitable equipment. Mulch shall be cut into the soil with equipment capable of cutting the mulch uniformly into the soil. Mulching shall be done within 24 hours of the time seeding is completed.

ROLLING:

After seeding and mulching, a cultipacker, traffic roller, or other suitable equipment shall be used for rolling the grassed areas. Areas shall then be watered with a fine spray.

WINTER COVER:

All areas to be grassed shall be protected against erosion at all times. For protection during the winter months (November 1st through March 31st) Italian rye grass shall be planted at the rate of four pounds per 1,000 square feet on all areas which are not protected by permanent grass.

CLEAN-UP:

All excess soil, excess grass materials, stones, and other waste shall be removed from the site daily and not allowed to accumulate.

MAINTENANCE:

Maintenance shall begin immediately following the last operation of grassing and continue until final acceptance. Maintenance shall include watering, mowing, replanting and all other work necessary to produce a uniform stand of grass. Grassing will be considered for final acceptance when the permanent grass is healthy and growing on 97% of the area with no bare areas wider than 12 inches.

ACCEPTANCE:

The Contractor shall submit to the Owner two copies of a written request for final acceptance of the grassing work. The request shall be submitted at least ten days prior to the anticipated date of acceptance. The condition of the grass will be noted, the Contractor will be notified if maintenance is to continue.

TECHNICAL SPECIFICATIONS FOR GLENDALE FIRE STATION SECTION 02211-SODDING

PART 1 - GENERAL

WORK INCLUDED:

Sod Installation

REFERENCES:

ASPA - American Sod Producers Association - Guideline Specifications to Sodding.

FS O-F-241 - Fertilizers, Mixed, Commercial.

DEFINITIONS:

Weeds: Includes Dandelion, Jimsonweed, Quackgrass, Horsetail, Morning Glory, Rush Grass, Mustard, Lambsquarter, Chickweed, Cress, Crabgrass, Canadian Thistle, Nutgrass, Poison Oak, Blackberry, Tansy Ragwort, Bermuda Grass, Johnson Grass, Poison Ivy, Nut Sedge, Nimble Hill, Bindweed, Bent Grass, Wild Garlic, Perennial Sorrel, and Brome Grass.

DELIVERY, STORAGE, AND HANDLING:

Deliver sod on pallets. Protect exposed roots from dehydration. Do not deliver more sod that can be laid within 24 hours.

PART 2 - PRODUCTS

ACCEPTABLE SOD GROWERS:

Nurseries and Sod Growers in the surrounding area who have a five year record are acceptable.

MATERIALS:

Sod: ASPA approved, field grown grade; cultivated grass sod; for low maintenance and traffic durability, with strong fibrous root system, free of stone, burned or bare spots; containing no more than 5 weeds per 1000 square feet.

Approved Sods: Bermuda, (Cynodon Dactylon).

HARVESTING SOD:

Machine cut sod and load on pallets in accordance with ASPA guidelines.

Cut sod in area not exceeding one square yard, with minimum 1/2 inch and maximum one inch topsoil base.

PART 3 - EXECUTION

INSPECTION:

Verify that prepared soil base is ready to receive the work of this Section.

Beginning of installation means acceptance of existing site conditions.

PREPARATION OF SUBSOIL:

Prepare subsoil to eliminate uneven areas and low spots. Maintain lines, levels, profiles and contours. Make changes in grade gradual. Blend slopes into level areas.

Remove foreign materials and undesirable plants and their roots. Do not bury foreign material beneath areas to be sodded. Remove contaminated subsoil.

LAYING SOD:

Moisten prepared surface immediately prior to laying sod.

Lay sod immediately on delivery to site and within 24 hours after harvesting to prevent deterioration.

Lay sod tight with no open joints visible, and no overlapping; stagger end joints 12-inches overlapping; minimum. Do not stretch or overlap sod pieces.

Lay smooth. Align with adjoining grass areas. Place top elevation of sod 1/2 inch below adjoining paving or curbs.

On slopes 6 inches per foot and steeper, lay sod perpendicular to slope and secure every row with wooden pegs at maximum 2 feet on center. Drive pegs flush with soil portion of sod.

Prior to placing sod, on slopes exceeding 8 inches per foot or where indicated, place wire mesh over topsoil. Securely anchor in place with wood pegs sunk firmly into the ground.

Water sodded areas immediately after installation. Saturate sod to 4 inches of soil.

After sod and soil have dried, roll sodded areas to ensure good bond between sod and soil and to remove minor depressions and irregularities.

Sod shall be laid in all ditch areas and slopes that are steeper than or equal to 1 vertical to 3 horizontal. Sod shall be pinned down for stabilization in these areas. Sod shall be placed in all swales and 24" next to all above ground structures. This includes but not limited to roads, valve boxes, fences, sidewalks, and lift stations.

In erosion areas, the contractor shall sod per the Engineer's direction if erosion persists overtime.

END OF SECTION

TECHNICAL SPECIFICATIONS FOR GLENDALE FIRE STATION SECTION 02800-IRRIGATION

PART 1 - GENERAL

SCOPE:

These specifications and accompanying drawings are intended to provide an automatic zones sprinkler system for the appropriate planting and sodded areas. The information contained herein is set forth as a guide and should not be construed to limit the contractors responsibility to provide a complete and working irrigation system.

RELATED DOCUMENTS:

Drawings and general provisions of Contract, including General and Supplemental Conditions.

JOB CONDITIONS:

Contractor should examine the work site. He should verify all existing site and construction conditions affecting his work and the work of others. Unsatisfactory conditions shall be reported to the engineer in writing via the general contractor before commencement of work is scheduled.

DESCRIPTION OF WORK:

- Extent of irrigated area is shown on drawings.
- All areas required to receive seeding, sodding, and landscaping shall be irrigated unless noted otherwise.

COORDINATION OF WORK:

Special coordination shall be necessary between the plumbing, electrical, paving, landscaping, and utility installers. It is the contractors responsibility to determine the location of all underground utilities and perform work in a manner which will avoid damages. Damages if any, shall be repaired in manner approved by the Engineer.

QUALITY ASSURANCE:

- Product Delivery, Storage and Handling

All materials shall be new and unused and shall be delivered to the job site in proper containers. The storage of materials on job site shall be coordinated with other contractors whose work is affected. Special storage requirements shall be coordinated with the project superintendent or general contractor. Handling shall be accomplished in a careful manner to avoid damage to equipment and materials.

- Manufacturer Qualifications

Provide underground irrigation system as a complete unit produced by a single acceptable manufacturer, including heads, valves, piping circuits, controls and accessories.

- Irrigation Contractor - Credentials and Qualification

The work shall be accomplished by qualified Irrigation Installers working under the direction of an experienced supervisor. The contractor shall submit references when requested by the engineer showing satisfactory work performed in similar size projects. The contractor, at the discretion of the engineer, may have to post a performance bond. Unless otherwise specified, it is the responsibility of the contractor to provide for all approvals, insurance, inspections, bonds, samplings, testing, and permits necessary to accomplish the work.

SUBMITTALS:

Product Data - submit manufacturer's technical data and installation instructions for underground irrigation system to the engineer for approval before commencement of work schedule.

PART 2 - PRODUCTS AND MATERIALS

ACCEPTABLE MANUFACTURERS:

Subject to compliance with requirements, manufacturers offering commercial grade products which may be incorporated in the work include, but are not limited to, the following:

- Rain Bird Sprinkler Manufacturing Corporation
- Hunter

EQUIPMENT SUBSTITUTIONS:

Deviations from specified equipment must be approved in writing in advance of installation by the owner or his representative. Supportive documents shall be provided to prove acceptability.

MATERIALS:

- Pressure Pipe - Comply with following:
 1. 3" and larger, galvanized steel pipe or PVC schedule 40 ANSI/ASTM D1785, ANSI/ASTM A120, schedule 40.
 2. Under 3", galvanized steel pipe or PVC pipe schedule 40 ANSI/ASTM D1785, ANSI/ASTM A120, schedule 40.
- Circuit Pipe (downstream from circuit valves) Comply with one of the following:
 1. PVC plastic pipe. ANSI/ASTM D1785, schedule 40 or class 200 PVC.
- Pipe Fittings - Comply with one of the following:

1. For PVC plastic pipe. ANSI/ASTM D2467 socket fittings with ASTM D2564 solvent cement.

- System Components

All system components, including but not limited to the controller, electric valves, sprinkler heads, bubblers, backflow preventer are to be either Rain Bird or Hunter commercial grade and specified by the irrigation contractor. Sizing and location should ensure coverage of all new landscaping. Every tree shall receive a commercial grade flood bubbler. The quantity of zones should be determined by the contractor after visiting the site and checking available flow and pressure of the existing water service. The controller shall be tamper proof and resistant to a salt air environment. All valves shall be placed in a valve box in an area approved by the engineer.

PART 3 - EXECUTION

SYSTEM DESIGN:

- Location of Heads: Design location is approximate. Make minor adjustments as necessary to avoid plantings and other obstructions.
- Minimum Water Coverage: Shrubs and Trees, 100%
- Layout may be modified, if necessary to obtain coverage, to suit manufacturers standard heads. Do not decrease number of heads indicated unless otherwise acceptable to Architect/Engineer.

TRENCHING AND BACKFILLING:

- General: Excavate straight and true with bottom uniformly sloped to low points.
- Protect existing lawns and plantings. Remove and replant as necessary to complete installation. Replace damaged lawn areas and plants with new to match existing.
- Trench Depth: Excavate trenches to a depth of 3" below invert of pipe, unless otherwise indicated.
- Minimum Cover: Provide the following minimum cover over top of installed piping:
- PVC Piping, 20" for mainline: 12" for laterals
- Backfill: Backfill with clean material for excavation. Remove organic material as well as rocks and debris larger than 1" diameter. Place acceptable backfill material in 6" lifts, compacting each lift.

- Existing Lawns: Where trenching is required across existing lawns, uniformly cut strips of sod 6" wider than trench. Remove sod in rolls of suitable size for handling and keep moistened until replanted.
- Backfill trench to within 6" of finished grade. Continue fill with acceptable topsoil and compact to bring sod even with existing lawn.
- Replant sod within 7 days after removal, roll and water generously.
- Pavements: Where existing pavements must be cut to install landscape irrigation systems, cut smoothly to straight lines 6" wider than trench.
- Excavate trench to required depth and width.
- Remove cut out pavement and excavated material from the site.
- At walkways, jack piping under paving material if possible.
- Backfill with dry sand fill material, placing in 6" lifts.
- Repair or replace pavement cuts with equivalent materials and finishes.

INSTALLATION:

- General: Unless otherwise indicated, comply with requirements of the Uniform Plumbing Code.
- Water Source: Service is existing at the restroom on site.
- Piping: Lay pipe on solid subbase, uniformly sloped without humps or depressions.
 1. Install PVC pipe in dry weather when temperature is above 40 degrees F (4 degrees C) in strict accordance with manufacturer's instructions. Allow joints to cure at least 24 hours at temperature above 40 degrees F (4 degrees C) before testing, unless otherwise recommended by manufacturer.
 2. Restore plantings disturbed by this work.
- Sprinkler Heads: Flush circuit lines with full head of water and install heads after hydrostatic test is completed.
 1. Install pop-up lawn and shrubbery heads at manufacturer's recommended heights.
 2. Install fixed riser shrubbery heads at heights indicated. Located part-circle heads to maintain a minimum distance of 4" from walls and 2" from other boundaries, unless otherwise indicated.

TESTING:

- General: Notify Architect/Engineer in writing when testing will be conducted. Conduct tests in presence of Architect/Engineer.
- Hydrostatic Test: Test water piping and valves, before backfilling trenches, to a hydrostatic pressure of not less than 100 PSI. Piping may be tested in sections to expedite work. Remove and repair piping, connections, valves which do not pass hydrostatic testing.
- Operational Testing: Perform operational testing after hydrostatic testing is completed, backfill is in place, and sprinkler heads adjusted to final position.
 1. Demonstrate to Engineer that system meets coverage requirements and that automatic controls function properly.
 2. Coverage requirements are based on operation of one circuit at a time.
- After completion of grading, seeding or sodding, and rolling of grass areas, carefully adjust lawn sprinkler heads so they will be flush with or not more than 1/2" above finish grade.

WARRANTY:

- The contractor will be responsible for the operation of the system for one year after completion of work.

**TECHNICAL SPECIFICATIONS FOR GLENDALE FIRE STATION
SECTION 02830-CHAIN LINK FENCING AND GATES**

PART 1 - GENERAL

RELATED DOCUMENTS:

Drawings and general provisions of Contract apply to work of this section.

DESCRIPTION OF WORK:

Extent of chain link fences and gates is indicated on drawings.

QUALITY ASSURANCE:

Provide chain link fences and gates as complete units controlled by a single source including necessary erection accessories, fittings, and fastenings.

PART 2 - PRODUCTS

GENERAL:

Dimensions indicated for pipe, roll-formed, and H-sections are outside dimensions, exclusive of coatings.

Available Manufacturers: Subject to compliance with requirements, manufacturers offering products which may be incorporated in the work include, but are not limited to, the following:

Galvanized Steel Fencing and Fabric:
Allied Tube and Conduit Corp.
American Fence Corp.
Anchor Fence, Inc.
Storm Fence Company

Aluminum Fencing and Fabric:
Chain Link Fence Company of Pennsylvania
Security Fabricators, Inc.

STEEL FABRIC:

Fabric: No. 9 ga. (0.148" ± 0.005") size steel wires, 2" mesh, with top salvage knuckled for fabric 60" high and under, and both top and bottom selvages twisted and barbed for fabric over 60" high.

Furnish one-piece fabric widths for fencing up to 12' high.

Fabric Finish: Galvanized, ASTM A 392, Class I, with not less than 1.2 oz. zinc per sq. ft. of surface.

FRAMING AND ACCESSORIES:

Steel Framework, General: Galvanized steel, ASTM A 120 or A 123, with not less than 1.8 oz. zinc per sq. ft. of surface.

Fittings and Accessories: Galvanized, ASTM A 153, with zinc weights per Table I.

End, Corner and Pull Posts: Minimum sizes and weights as follows:

3" OD steel pipe, 5.79 lbs. per lin. ft., 2.5" x 2.5" roll-formed sections, 5.70 lbs. per lin. ft.

Line Posts: Space 10' o.c. maximum, unless otherwise indicated, of following minimum sizes and weights.

Up to 6' fabric height, 2.00" OD steel pipe, 3.27 lbs. per lin. ft.

6' to 8' fabric height, 2.5" OD steel pipe, 3.65 lbs. per lin. ft.

Over 8' fabric height, 2.875" OD steel pipe, 5.79 lbs. per lin. ft.

Gate Posts: Furnish posts for supporting single gate leaf, or one leaf of a double gate installation, for nominal gate widths as follows:

| <u>Leaf Width</u> | <u>Gate Post</u> | <u>Lbs./lin. ft.</u> |
|-------------------|---|----------------------|
| Up to 6' | 3.5" x 3.5" roll-formed section or 2.875" OD pipe | 4.85 5.79 |
| Over 6' to 13' | 4.000" OD pipe | 9.11 |
| Over 13' to 18' | 6.625" OD pipe | 18.97 |
| Over 18' | 8.625" OD pipe | 28.55 |

Top Rail: Manufacturer's longest lengths, with expansion type couplings, approximately 6" long, for each joint. Provide means for attaching top rail securely to each gate corner, pull and end posts.
1.66" OD pipe, 2.27 lbs. per ft.

Tension Wire: 7-gage, coated coil spring wire, metal and finish to match fabric.

Locate at bottom of fabric.

Wire Ties: 9 ga. galvanized steel or 9 ga. aluminum wire, to match fabric core material.

Post Brace Assembly: Manufacturer's standard adjustable brace at end and gate posts and at both sides of corner and pull posts, with horizontal brace located at mid-height of fabric. Use same materials as top rail for brace, and truss to line posts with 0.375" diameter rod and adjustable tightener.

Post Tops: Provide weathertight closure cap with loop to receive tension wire or top rail; one cap for each post.

Stretcher Bars Bands: Space not over 15" o.c., to secure stretcher bars to end, corner, pull, and gate posts.

Barbed Wire Supporting Arms: Manufacturer's standard barbed wire supporting arms, metal and finish to match fence framework, with provision for anchorage to posts and attaching 3 rows of barbed wire to each arm. Supporting arms may be either attached to posts or integral with post top weather cap and must be capable of withstanding 250 lbs. downward pull at outermost end. Provide following type:

Single 45 degrees arm; for 3 strands barbed wire, one for each post.

Barbed Wire: 2 strand, 12-1/2 ga. wire with 14 ga. 4-point barbs spaced not more than 5" o.c.; metal and finish to match fabric.

GATES:

Fabrication: Fabricate perimeter frames of gates from metal and finish to match fence framework. Assemble gate frames by welding or with special fittings and rivets, for rigid connections, providing security against removal or breakage connections. Provide horizontal and vertical members to ensure proper gate operation and attachment of fabric, hardware and accessories. Space frame members maximum of 8' apart unless otherwise indicated.

Provide same fabric as for fence, unless otherwise indicated. Install fabric with stretcher bars at vertical edges and at top and bottom edges. Attach stretcher bars to gate frame at not more than 15" o.c.

Install diagonal cross-bracing consisting of 3/8" diameter adjustable length truss rods on gates to ensure frame rigidity without sag or twist.

Where barbed wire is indicated above gates, extend end members of gate frames 1' above to member and prepare to receive 3 strands of wire. Provide necessary clips for securing wire to extensions.

Swing Gates: Fabricate perimeter frames of minimum 1.90" OD pipe.

Gate Hardware: Provide hardware and accessories for each gate, galvanized per ASTM A 153, and in accordance with the following:

Hinges: Size and material to suit gate size, non-lift-off type, offset to permit 180 degree gate opening. Provide 1-1/2 pair of hinges for each leaf over 6' nominal height.

Latch: Forked type or plunger-bar type to permit operation from either side of gate, with padlock eye as integral part of latch.

Keeper: Provide keeper for vehicle gates, which automatically engages gate leaf and holds it in open position until manually released.

Double Gates: Provide gate stops for double gates, consisting of mushroom type flush plate with anchors, set in concrete, and designed to engage center drop rod or plunger bar. Include locking device and padlock eyes as integral part of latch, permitting both gate leaves to be locked with single padlock.

Concrete: Provide concrete consisting of portland cement, ASTM C 150, aggregates ASTM C 33, and clean water. Mix materials to obtain concrete with a minimum 28-day compressive strength of 2500 psi using at least 4 sacks of cement per cu. yd., 1" maximum size aggregate, maximum 3" slump, and 2% to 4% entrained air.

PART 3 - EXECUTION

INSTALLATION:

Do not begin installation and erection before final grading is completed, unless otherwise permitted. Excavation: Drill or hand excavate (using post hole digger) holes for posts to diameters and spacings indicated, in firm, undistributed or compacted soil.

If not indicated on drawings, excavate holes for each post to minimum diameters as recommended by fence manufacturer, but not less than 4 times largest cross-section of post.

Unless otherwise indicated, excavate hole depths approximately 3" lower than post bottom, with bottom of posts set not less than 36" below finish grade surface.

Setting Posts: Center and align posts in holes 3" above bottom of excavation.

Place concrete around posts and vibrate or tamp for consolidation. Check each post for vertical and top alignment, and hold in position during placement and finishing operations.

Unless otherwise indicated, extend concrete footings 2" above grade and trowel to a crown to shed water.

Top Rails: Run rail continuously through post caps, bending to radius for curved runs. Provide expansion couplings as recommended by fencing manufacturer.

Brace Assemblies: Install braces so posts are plumb when diagonal rod is under proper tension.

Tension Wire: Install tension wires through post cap loops before stretching fabric and tie to each post cap with not less than 6 ga. galvanized wire. Fasten fabric to tension wire using 11 ga. galvanized steel hog rings spaced 24" o.c.

Fabric: Leave approximately 2" between finish grade and bottom salvage, unless otherwise indicated. Pull fabric taut and tie to posts, rails, and tension wires. Install fabric on security side of fence, and anchor to framework so that fabric remains in tension after pulling force is released.

Stretcher Bars: Thread through or clamp to fabric 4" o.c., and secure to posts with metal bands spaced 15" o.c.

Barbed Wire: Pull wire taut and install securely to extension arms and secure to end post or terminal arms in accordance with manufacturer's instructions.

Gates: Install gates plumb, level, and secure for full openings without interference. Install ground-set items in concrete for anchorage. Adjust hardware for smooth operation and lubricate where necessary.

Tie Wires: Use U-shaped wire, conforming to diameter of pipe to which attached, clasping pipe and fabric firmly with ends twisted at least 2 full turns. Bend ends of wire to minimize hazard to persons or clothing.

Tie fabric to line posts, with wire ties spaced 12" o.c. Tie fabric to rails and braces, with wire ties spaced 18" o.c. Tie fabric to tension wires, with hog rings spaced 24" o.c.

Fasteners: Install nuts for tension bands and hardware bolts on side of fence opposite fabric side. Peen ends of bolts or score threads to prevent removal of nuts.

Electrical Grounds: The fence shall be grounded by a Copperweld rod ten (10) feet long and a minimum of 5/8 inch diameter, driven vertically until the top of it is approximately one foot below the top of ground. A No. 6 solid copper conductor shall be brazed to the rod and to the fence in such a manner that each element of the fence is grounded. Electrical ground shall be installed at intervals not exceeding 500 feet and, where a power line passes over the fence, a ground shall be installed immediately below the point of crossing.

END OF SECTION 02830

TECHNICAL SPECIFICATIONS FOR GLENDALE FIRE STATION SECTION 02500-PAVING QUALITY CONTROL SYSTEM

GENERAL REQUIREMENTS:

The Contractor shall furnish and maintain a quality control system that will provide reasonable assurance that all materials and products submitted to the Engineer for acceptance conform to the contract requirements whether manufactured or processed by the Contractor or procured from suppliers or subcontractors. The Contractor shall perform or have performed the inspection and tests required to substantiate product conformance to contract requirements and shall also perform or have performed all inspections and tests otherwise required by the contract. The Contractor shall have a Quality Control Technician, who has been certified by F.D.O.T. as a Certified Asphalt Plant Technician, available at the asphalt plant at all times the Contractor is producing asphalt mix for the contract. The Contractor's quality control procedures, inspection, and tests shall be documented and that information be available for review by the Engineer throughout the life of the contract.

The Contractor's person in responsible charge of the paving operations shall also be certified by the F.D.O.T. as an Asphalt Paving Technician and shall possess a valid certificate of qualification, and be present during all paving operations.

ENGINEER'S INSPECTION:

The Engineer reserves the right to inspect materials not manufactured within the Contractor's facility. The Engineer inspection shall not constitute acceptance nor shall it in any way replace the Contractor's inspection or otherwise relieve the Contractor of his responsibility to furnish an acceptable material or product. When inspection of the subcontractor's or supplier's product is performed by the Engineer, such inspection shall not be used by the Contractor as evidence of effective inspection of such subcontractor's or supplier's product.

**TECHNICAL SPECIFICATIONS FOR GLENDALE FIRE STATION
SECTION 02505-PAVING CONSTRUCTION DETAILS AND MATERIALS**

PART 1 - GENERAL

Unless otherwise stated in the project plans or specifications, the Contractor will be required to follow all general requirements and covenants, construction methods and materials, to meet the specifications set forth in the Florida Department of Transportation Standard Specifications for Road and Bridge Construction, latest edition, and any new or amended sections in effect prior to the date of bid opening. Testing procedures shall be as specified in Section 02520 of these specifications. Results of testing shall be as set forth by the Florida Department of Transportation for road construction.

There will be no asphalt or fuel escalators allowed under this contract.

**TECHNICAL SPECIFICATIONS FOR GLENDALE FIRE STATION
SECTION 02510-GENERAL CONSTRUCTION REQUIREMENTS FOR ASPHALT
PAVEMENT**

HOT MIX ASPHALT

Construct a Hot Mix Asphalt (HMA) pavement based on the type of work specified in the Contract and the Asphalt Work Categories as defined below. Meet the applicable requirements for plants, equipment, and construction requirements as defined below. Use a HMA mix that meets the requirements of this specification

Asphalt Work Mix Categories: Construction of Hot Mix Asphalt Pavement will fall into one of the following work categories:

Asphalt Work Category 1: Includes the construction of bike paths and miscellaneous asphalt.

Asphalt Work Category 2: Includes the construction of new HMA turn lanes, paved shoulders and other non-mainline pavement locations.

Asphalt Work Category 3: Includes the construction of new mainline HMA pavement lanes, milling and resurfacing.

Mix Types: Use the appropriate HMA mix as shown in Table 334-1.

| Table 334-1 HMA Mix Types | | | |
|------------------------------|--|---------------|------------------|
| Asphalt Work Category | Mix Types | Traffic Level | ESALs (millions) |
| 1 | Type SP-9.5 ⁽¹⁾ | A | <0.3 |
| 2 | Structural Mixes: Types SP-9.5 or SP-12.5 ⁽¹⁾ Friction Mixes: Types FC-9.5 or FC-12.5 ⁽¹⁾ | B | 0.3 to <3 |
| 3 | Structural Mixes: Types SP-9.5 or SP-12.5 Friction Mixes: Types FC-9.5 or FC-12.5 | C | ≥3 |

(1) Equivalent mixes may be approved as determined by the Engineer. For example, Marshall S-III mixture type is equivalent to Superpave SP-9.5, Marshall S-I is equivalent to Superpave SP-12.5, and Marshall FC-3 is equivalent to Superpave FC-9.5.

A Type SP or FC mix one traffic level higher than the traffic level specified in the Contract may be substituted, at no additional cost (i.e. Traffic Level B may be substituted for Traffic Level A, etc.). Traffic levels are as defined in Section 334 of the Department’s Standard Specifications for Road and Bridge Construction.

Gradation Classification: HMA mixes are classified as either coarse or fine, depending on the overall gradation of the mixture. Coarse and fine mixes are defined in 334-3.2.2. Use only fine mixes.

The equivalent AASHTO nominal maximum aggregate size Superpave mixes are as follows:

| | |
|-----------------------------|---------|
| Type SP-9.5, FC-9.5 | 9.5 mm |
| Type SP-12.5, FC-12.5 | 12.5 mm |

Thickness: The total pavement thickness of the HMA pavement will be based on a specified spread rate or plan thickness as shown in the Contract Documents. Before paving, propose a spread rate or thickness for each individual layer meeting the requirements of this specification, which when combined with other layers (as applicable) will equal the plan spread rate or thickness. When the total pavement thickness is specified as plan thickness, the plan thickness and individual layer thickness will be converted to spread rate using the following equation:

$$\text{Spread rate (lbs/yd}^2\text{)} = t \times G_{mm} \times 43.3$$

where: t = Thickness (in.) (Plan thickness or individual layer thickness)
 G_{mm} = Maximum specific gravity from the mix design

For target purposes only, spread rate calculations shall be rounded to the nearest whole number.

Layer Thicknesses: Unless otherwise called for in the Contract Documents, the allowable layer thicknesses for HMA mixtures are as follows:

| | |
|-----------------------------|----------------------|
| Type SP-9.5, FC-9.5 | 3/4 – 1-1/2 inches |
| Type SP-12.5, FC-12.5 | 1 1/2 – 2-1/2 inches |

Additional Requirements: The following requirements also apply to HMA mixtures:

1. When construction includes the paving of adjacent shoulders (less than or equal to 5 feet wide), the layer thickness for the upper pavement layer and shoulder shall be the same and paved in a single pass, unless otherwise called for in the Contract Documents.
2. For overbuild layers, use the minimum and maximum layer thicknesses as specified above unless called for differently in the Contract Documents. On variable thickness overbuild layers, the minimum allowable thickness may be reduced by 1/2 inch, and the maximum allowable thickness may be increased by 1/2 inch, unless called for differently in the Contract Documents.

Weight of Mixture: The weight of the mixture shall be determined as provided in 320-3.2 of the Florida Department of Transportation (FDOT) specifications.

MATERIALS

Superpave Asphalt Binder: Unless specified elsewhere in the Contract or in 334-2.3.3, use a PG 67-22 asphalt binder from the FDOT’s Qualified Products List (QPL). If the Contract calls for an alternative binder, meet the requirements of FDOT Specifications Section 336 or 916, as appropriate.

Aggregate: Use aggregate capable of producing a quality pavement.

For Type FC mixes, use an aggregate blend that consists of crushed granite, crushed Oolitic limestone, other crushed materials (as approved by FDOT for friction courses per Rule 14-103.005, Florida Administrative Code), or a combination of the above. Crushed limestone from the Oolitic formation may be used if it contains a minimum of 12% silica material as determined by FDOT Test Method FM 5-510 and FDOT grants approval of the source prior to its use. As an exception, mixes that contain a minimum of 60% crushed granite may either contain:

1. Up to 40% fine aggregate from other sources; or,
2. A combination of up to 20% RAP and the remaining fine aggregate from other sources.

A list of aggregates approved for use in friction courses may be available on the FDOT's State Materials Office website. The URL for obtaining this information, if available, is: <ftp://ftp.dot.state.fl.us/fdot/smo/website/sources/frictioncourse.pdf>.

RECLAIMED ASPHALT PAVEMENT (RAP) MATERIAL:

General requirements: RAP may be used as a component of the asphalt mixture, if approved by the Engineer. Usage of RAP is subject to the following requirements:

1. Limit the amount of RAP material used in the mix to a maximum of 50% by weight of total aggregate.
2. Provide stockpiled RAP material that is reasonably consistent in characteristics and contains no aggregate particles which are soft or conglomerates of fines.
3. Provide RAP material having a minimum average asphalt content of 4.0% by weight of total mix. The Engineer may sample the stockpile to verify that this requirement is met.
4. Use a grizzly or grid over the RAP cold bin, in-line roller crusher, screen, or other suitable means to prevent oversized RAP material from showing up in the completed recycle mixture. If oversized RAP material appears in the completed recycle mix, take the appropriate corrective action immediately. If the appropriate corrective actions are not immediately taken, stop plant operations.

Material Characterization: Assume responsibility for establishing the asphalt binder content, gradation, viscosity and bulk specific gravity (G_{sb}) of the RAP material based on a representative sampling of the material.

Asphalt Binder for Mixes with RAP: Select the appropriate asphalt binder grade based on Table 334-2. Maintain the viscosity of the recycled mixture within the range of 5,000 to 15,000 poises.

| Percent RAP | Asphalt Binder Grade |
|-------------|----------------------|
| < 20 | PG 67-22 |
| 20 – 29 | PG 64-22 |
| ≥ 30 | Recycling Agent |

COMPOSITION OF MIXTURE

General: Compose the asphalt mixture using a combination of aggregates, mineral filler, if required, and asphalt binder material. Size, grade and combine the aggregate fractions to meet the grading and physical properties of the mix design. Aggregates from various sources may be combined.

MIX DESIGN

General: Design the asphalt mixture in accordance with AASHTO R 35-09, except as noted herein. Submit the proposed mix design with supporting test data indicating compliance with all mix design criteria to the Engineer. Prior to the production of any asphalt mixture, obtain the Engineer's conditional approval of the mix design. If required by the Engineer, send representative samples of all component materials, including asphalt binder to a laboratory designated by the Engineer for verification. As an exception to these requirements, use a currently approved FDOT Mix Design.

The Engineer will consider any marked variations from original test data for a mix design or any evidence of inadequate field performance of a mix design as sufficient evidence that the properties of the mix design have changed, and at his discretion, the Engineer may no longer allow the use of the mix design.

Mixture Gradation Requirements: Combine the aggregates in proportions that will produce an asphalt mixture meeting all of the requirements defined in this specification and conform to the gradation requirements at design as defined in AASHTO M 323-07, Table 3. Aggregates from various sources may be combined.

Mixture Gradation Classification: Plot the combined mixture gradation on an FHWA 0.45 Power Gradation Chart. Include the Control Points from AASHTO M323-07, Table-3, as well as the Primary Control Sieve (PCS) Control Point from AASHTO M323-07, Table 4. Fine mixes are defined as having a gradation that passes above or through the primary control sieve control point. Use only fine mixes.

Gyratory Compaction: Compact the design mixture in accordance with AASHTO T312-09. Use the number of gyrations as defined in AASHTO R35-09, Table 1.

Design Criteria: Meet the requirements for nominal maximum aggregate size as defined in AASHTO M323-07, as well as for relative density, VMA, VFA, and dust-to-binder ratio as specified in AASHTO M323-07, Table 6.

Moisture Susceptibility: Test 4 inch specimens in accordance with FM 1-T 283. Provide a mixture having a retained tensile strength ratio of at least 0.80 and a minimum tensile strength (unconditioned) of 100 psi. If necessary, add a liquid anti-stripping agent from the FDOT's Qualified Products List or hydrated lime in order to meet these criteria.

In lieu of moisture susceptibility testing, add a liquid anti-stripping agent from the FDOT's Qualified Products List. Add 0.5% liquid anti-stripping agent by weight of binder.

Additional Information: In addition to the requirements listed above, provide the following information on each mix design:

1. The design traffic level and the design number of gyrations (N_{design}).
2. The source and description of the materials to be used.
3. The FDOT source number and the FDOT product code of the aggregate components furnished from an FDOT approved source (if required).
4. The gradation and proportions of the raw materials as intended to be combined in the paving mixture. The gradation of the component materials shall be representative of the material at the time of use. Compensate for any change in aggregate gradation caused by handling and processing as necessary.
5. A single percentage of the combined mineral aggregate passing each specified sieve. Degradation of the aggregate due to processing (particularly material passing the No. 200 sieve) should be accounted for and identified.
6. The bulk specific gravity (G_{sb}) value for each individual aggregate and RAP component.
7. A single percentage of asphalt binder by weight of total mix intended to be incorporated in the completed mixture, shown to the nearest 0.1%.
8. A target temperature at which the mixture is to be discharged from the plant and a target roadway temperature. Do not exceed a target temperature of 330°F for modified asphalts and 315°F for unmodified asphalts.
9. Provide the physical properties achieved at four different asphalt binder contents. One shall be at the optimum asphalt content, and must conform to all specified physical requirements.
10. The name of the mix designer.
11. The ignition oven calibration factor.

PROCESS CONTROL

Assume full responsibility for controlling all operations and processes such that the requirements of these Specifications are met at all times. Perform any tests necessary at the plant and roadway to control the process.

GENERAL CONSTRUCTION REQUIREMENTS

Weather Limitations: Do not transport asphalt mix from the plant to the roadway unless all weather conditions are suitable for the laying operations.

LIMITATIONS OF LAYING OPERATIONS

General: Spread the mixture only when the surface upon which it is to be placed has been previously prepared, is intact, firm, and properly cured, and is dry.

Air Temperature: Spread the mixture only when the air temperature in the shade and away from artificial heat is at least 40°F for layers greater than 1 inch (100 lb per square yard) in thickness and at least 45°F for layers 1 inch (100 lb per square yard) or less in thickness (this includes leveling courses). The minimum temperature requirement for leveling courses with a spread rate of 50 lb per square yard or less is 50°F.

Mix Temperature: Heat and combine the ingredients of the mix in such a manner as to produce a mixture with a temperature at the plant and at the roadway, within a range of plus or minus 30°F from the target temperature as shown on the mix design. Reject all loads outside of this range.

Transportation of the Mixture: Transport the mixture in vehicles previously cleaned of all foreign material. After cleaning, thinly coat the inside surface of the truck bodies with soapy water or an asphalt release agent as needed to prevent the mixture from adhering to the beds. Do not allow excess liquid to pond in the truck body. Do not use diesel fuel or any other hazardous or environmentally detrimental material as a coating for the inside surface of the truck body. Cover each load at all times.

PREPARATION OF SURFACES PRIOR TO PAVING:

Cleaning: Clean the surface of all loose and deleterious material by the use of power brooms or blowers, supplemented by hand brooming where necessary.

Patching and Leveling Courses: As shown in the plans, bring the existing surface to proper grade and cross-section by the application of patching or leveling courses.

Application over Surface Treatment: Where an asphalt mix is to be placed over a surface treatment, sweep and dispose of all loose material from the paving area.

Tack Coat: Use a rate of application as defined in Table 334-3. Control the rate of application to be within plus or minus 0.01 gal. per square yard of the target application rate. The target application rate may be adjusted by the Engineer to meet specific field conditions. Determine the rate of application as needed to control the operation. When using RA-550, multiply the target rate of application by 0.6.

| Table 334-3 Tack Coat Application Rates | | |
|---|--|--|
| Asphalt Mixture Type | Underlying Pavement Surface | Target Tack Rate (gal/yd ²) |
| Base Course, Structural Course, Dense Graded Friction Course | Newly Constructed Asphalt Layers | 0.02 minimum |
| | Milled Surface or Oxidized and Cracked Pavement | 0.06 |
| | Concrete Pavement | 0.08 |
| Open Graded Friction Course | Newly Constructed Asphalt Layers | 0.05 |
| | Milled Surface | 0.07 |

PAVING

Alignment of Edges: With the exception of pavements placed adjacent to curb and gutter or other true edges, place all pavements by the stringline method to obtain an accurate, uniform alignment of the pavement edge. Control the unsupported pavement edge to ensure that it will not deviate more than plus or minus 1.5 inches from the stringline.

Rain and Surface Conditions: Immediately cease transportation of asphalt mixtures from the plant when rain begins at the roadway. Do not place asphalt mixtures while rain is falling, or when there is water on the surface to be covered. Once the rain has stopped and water has been removed from the tacked surface to the satisfaction of the Engineer and the temperature of the mixture caught in transit still meets the requirements as specified in 334-5.3, the Contractor may then place the mixture caught in transit.

Checking Depth of Layer: Check the depth of each layer at frequent intervals to ensure a uniform spread rate that will meet the requirements of the Contract.

Hand Spreading: In limited areas where the use of the spreader is impossible or impracticable, spread and finish the mixture by hand.

Spreading and Finishing: Upon arrival, dump the mixture in the approved paver, and immediately spread and strike-off the mixture to the full width required, and to such loose depth for each course that, when the work is completed, the required weight of mixture per square yard, or the specified thickness, is secured. Carry a uniform amount of mixture ahead of the screed at all times.

Thickness Control: Ensure the spread rate is within 10% of the target spread rate, as indicated in the Contract. When calculating the spread rate, use, at a minimum, an average of five truckloads of mix. When the average spread rate is beyond plus or minus 10% of the target spread rate, monitor the thickness of the pavement layer closely and adjust the construction operations.

If the Contractor fails to maintain an average spread rate within plus or minus 10% of the target spread rate for two consecutive days, the Engineer may elect to stop the construction operation at any time until the issue is resolved.

When the average spread rate for the total structural or friction course pavement thickness exceeds the target spread rate by ± 50 lbs per sy for layers ≥ 2.5 inches or exceeds the target spread rate by ± 25 lbs per sy for layers < 2.5 inches, address the unacceptable pavement in accordance with 334-5.10.4, unless an alternative approach is agreed upon by the Engineer.

LEVELING COURSES

Patching Depressions: Before spreading any leveling course, fill all depressions in the existing surface as shown in the plans.

Spreading Leveling Courses: Place all courses of leveling with an asphalt paver or by the use of two motor graders, one being equipped with a spreader box. Other types of leveling devices may be used upon approval by the Engineer.

Rate of Application: When using Type SP-9.5 (fine graded) for leveling, do not allow the average spread of a layer to be less than 50 pounds per square yard or more than 75 pounds per square yard. The quantity of mix for leveling shown in the plans represents the average for the entire project; however, the Contractor may vary the rate of application throughout the project as directed by the Engineer. When leveling in connection with base widening, the Engineer may require placing all the leveling mix prior to the widening operation.

Compaction: For each paving or leveling train in operation, furnish a separate set of rollers, with their operators.

When density testing for acceptance is required, select equipment, sequence, and coverage of rolling to meet the specified density requirement. Regardless of the rolling procedure used, complete the final rolling before the surface temperature of the pavement drops to the extent that effective compaction may not be achieved or the rollers begin to damage the pavement.

When density testing for acceptance is not required, use a rolling pattern approved by the Engineer.

Use hand tamps or other satisfactory means to compact areas which are inaccessible to a roller, such as areas adjacent to curbs, headers, gutters, bridges, manholes, etc.

JOINTS

Transverse Joints: Construct smooth transverse joints, which are within 3/16 inch of a true longitudinal profile when measured with a 15 foot manual straightedge. These requirements are waived for transverse joints at the beginning and end of the project and at the beginning and end of bridge structures, if the deficiencies are caused by factors beyond the control of the Contractor such as no milling requirement, as determined by the Engineer. When smoothness requirements are waived, construct a reasonably smooth transitional joint.

Longitudinal Joints: For all layers of pavement except the leveling course, place each layer so that longitudinal construction joints are offset 6 to 12 inches laterally between successive layers. Do not construct longitudinal joints in the wheel paths. The Engineer may waive these requirements where offsetting is not feasible due to the sequence of construction.

Surface Requirements: Construct a smooth pavement with good surface texture and the proper cross slope.

Texture of the Finished Surface of Paving Layers: Produce a finished surface of uniform texture and compaction with no pulled, torn, raveled, crushed or loosened portions and free of segregation, bleeding, flushing, sand streaks, sand spots, or ripples. Correct any area of the surface that does not meet the foregoing requirements in accordance with 334-5.10.4.

Cross Slope: Construct a pavement surface with cross slopes in compliance with the requirements of the Contract Documents.

Pavement Smoothness: Construct a smooth pavement meeting the requirements of this Specification. Furnish a 15 foot manual and a 15 foot rolling straightedge meeting the requirements of FM 5-509.

STRAIGHTEDGE TESTING

Acceptance Testing: Using a rolling straightedge, test the final (top) layer of the pavement. Test all pavement lanes where the width is constant using a rolling straightedge and document all

deficiencies on a form approved by the Engineer. Notify the Engineer of the location and time of all straightedge testing a minimum of 48 hours before beginning testing.

Final (Top) Pavement Layer: At the completion of all paving operations, straightedge the final (top) layer either behind the final roller of the paving train or as a separate operation. Address all deficiencies in excess of 3/16 inch in accordance with 334-5.10.4, unless waived by the Engineer. Retest all corrected areas.

Straightedge Exceptions: Straightedge testing will not be required in the following areas: shoulders, intersections, tapers, crossovers, sidewalks, bicycle/shared use paths, parking lots and similar areas, or in the following areas when they are less than 250 feet in length: turn lanes, acceleration/deceleration lanes and side streets. In the event the Engineer identifies a surface irregularity in the above areas that is determined to be objectionable, straightedge and address all deficiencies in excess of 3/8 inch in accordance with 334-5.10.4.

Correcting Unacceptable Pavement: Correct deficiencies in the pavement layer by removing and replacing the full depth of the layer, extending a minimum of 50 feet on both sides of the defective area for the full width of the paving lane, at no additional cost.

ACCEPTANCE AND MIXTURE

General: The asphalt mixture will be accepted based on the Asphalt Work Category as defined below:

1. Asphalt Work Category 1 – Certification by the Contractor as defined in 334-6.2.
2. Asphalt Work Category 2 – Certification and process control testing by the Contractor as defined in 334-6.3
3. Asphalt Work Category 3 – Process control testing by the Contractor and acceptance testing by the Engineer as defined in 334-6.4.

Certification by the Contractor: On Asphalt Work Category 1 construction, the Engineer will accept the mix on the basis of visual inspection. Submit a Notarized Certification of Specification Compliance letter on company letterhead to the Engineer stating that all material produced and placed on the project meets the requirements of the Specifications. The Engineer may run independent tests to determine the acceptability of the material.

Certification and Process Control Testing by the Contractor: On Asphalt Work Category 2 construction, submit a Notarized Certification of Specification Compliance letter on company letterhead to the Engineer stating that all material produced and placed on the project meets the requirements of the Specifications, along with supporting test data documenting all process control testing as described in 334-6.3.1. If required by the Contract, utilize an Independent Laboratory as approved by the Engineer for the process control testing. The mix will also require visual acceptance by the Engineer. In addition, the Engineer may run independent tests to determine the acceptability of the material. Material failing to meet these acceptance criteria will be addressed as directed by the Engineer such as but not limited to acceptance at reduced pay, delineation testing

to determine the limits of the questionable material, removal and replacement at no cost to the agency, or performing an Engineering analysis to determine the final disposition of the material. .

Process Control Sampling and Testing Requirements: Perform process control testing at a frequency of once per day. Obtain the samples in accordance with FDOT Method FM 1-T 168. Test the mixture at the plant for gradation (P₈ and P₂₀₀) and asphalt binder content (P_b). Measure the roadway density with 6 inch diameter roadway cores at a minimum frequency of once per 1,500 feet of pavement with a minimum of three cores per day.

Determine the asphalt binder content of the mixture in accordance with FM 5-563. Determine the gradation of the recovered aggregate in accordance with FM 1-T 030. Determine the roadway density in accordance with FM 1-T 166. The minimum roadway density will be based on the percent of the maximum specific gravity (G_{mm}) from the approved mix design. If the Contractor or Engineer suspects that the mix design G_{mm} is no longer representative of the asphalt mixture being produced, then a new G_{mm} value will be determined from plant-produced mix with the approval of the Engineer. Roadway density testing will not be required in certain situations as described in 334-6.4.1. Assure that the asphalt binder content, gradation and density test results meet the criteria in Table 334-4.

| Table 334-4 Process Control and Acceptance Values | |
|--|-----------------------------------|
| Characteristic | Tolerance |
| Asphalt Binder Content (percent) | Target ± 0.55 |
| Passing No. 8 Sieve (percent) | Target ± 6.00 |
| Passing No. 200 Sieve (percent) | Target ± 2.00 |
| Roadway Density (daily average) | Minimum 91.5% of G _{mm} |
| Roadway Density (any single core) | Minimum 88.0 % of G _{mm} |

Process Control Testing by the Contractor and Acceptance Testing by the Engineer: On Asphalt Work Category 3, perform process control testing as described in 334-6.3.1. In addition, the Engineer will accept the mixture at the plant with respect to gradation (P₈ and P₂₀₀) and asphalt binder content (P_b). The mixture will be accepted on the roadway with respect to density. The Engineer will sample and test the material as described in 334-6.3.1. The Engineer will randomly obtain at least one set of samples per day. Assure that the asphalt content, gradation and density test results meet the criteria in Table 334-4. Material failing to meet these acceptance criteria will be addressed as directed by the Engineer such as but not limited to acceptance at reduced pay, delineation testing to determine the limits of the questionable material, removal and replacement at no cost to the agency, or performing an Engineering analysis to determine the final disposition of the material.

Acceptance Testing Exceptions: When the total quantity of any mix type in the project is less than 500 tons, the Engineer will accept the mix on the basis of visual inspection. The Engineer may run independent tests to determine the acceptability of the material.

Density testing for acceptance will not be performed on widening strips or shoulders with a width of 5 feet or less, variable thickness overbuild courses, leveling courses, any asphalt layer placed on subgrade (regardless of type), miscellaneous asphalt pavement, bike/shared use paths,

crossovers, or any course with a specified thickness less than 1 inch or a specified spread rate less than 100 lb per square yard. Density testing for acceptance will not be performed on asphalt courses placed on bridge decks or approach slabs. In addition, density testing for acceptance will not be performed on the following areas when they are less than 1,000 feet continuous in length: turning lanes, acceleration lanes, deceleration lanes, shoulders, parallel parking lanes, or ramps. Density testing for acceptance will not be performed in intersections. The limits of the intersection will be from stop bar to stop bar for both the mainline and side streets. Compact these courses in accordance with a standard rolling procedure approved by the Engineer. In the event that the rolling procedure deviates from the approved procedure, placement of the mix will be stopped.

Method of Measurement.

For the work specified under this Section, the quantity to be paid for will be the weight of the mixture, in tons.

The bid price for the asphalt mix will include the cost of the liquid asphalt or the asphalt recycling agent and the tack coat application as specified in 334-5.5.4. There will be no separate payment or unit price adjustment for the asphalt binder material in the asphalt mix.

TECHNICAL SPECIFICATIONS FOR GLENDALE FIRE STATION SECTION 02516-LIMEROCK BASE COURSE

PART 1 - GENERAL

RELATED DOCUMENTS:

Drawings and general provisions of contract apply to the work of this section.

DESCRIPTION OF WORK:

This item shall consist of a base course composed of limerock constructed on a subgrade prepared in accordance with the specifications and in conformity with the line, grades and typical cross-section as shown on the drawings. The construction methods shall conform to the requirements of Section 200 of the Department of Transportation (DOT) Standards Specifications.

PART 2 - PRODUCTS

MATERIALS:

All material shall be secured from sources approved by the Engineer, and shall be furnished by the Contractor. Limerock material shall conform to Section 911 of the Standard Specifications.

EQUIPMENT:

The rock shall be spread by mechanical rock spreaders, equipped with a device which strikes off the rock uniformly to laying thickness, and capable of producing an even distribution of the rock. For crossovers, intersections and ramp areas; for roadway widths of 20 feet or less; for the main roadway area when forms are used and for any other areas where the use of a mechanical spreader is not practicable; spreading may be done by bulldozers or blade graders.

PART 3 - EXECUTION

TRANSPORTING LIMEROCK:

The limerock shall be transported to the point where it is to be used, over rock previously placed if practicable, and dumped on the end of the preceding spread. Hauling over the subgrade and dumping on the subgrade will be permitted when, in the Engineer's opinion, these operations will not be detrimental to the base.

SPREADING LIMEROCK:

Method of Spreading: The limerock shall be spread uniformly. All segregated areas of fine or coarse rock shall be removed and replaced with properly graded rock.

Number of Courses: When the specified compacted thickness of the base is greater than six inches, the base shall be constructed in two courses. The thickness of the first course shall be approximately one-half the total thickness of the finished base, or enough additional to bear the weight of the construction equipment without disturbing the subgrade.

COMPACTING AND FINISHING BASE:

GENERAL:

Single-Course Base: For single-course base, after the spreading is completed the entire surface shall be scarified and then shaped so as to produce the required grade and cross section after compaction.

Double-Course Base: For double-course base, the first course shall be cleaned of foreign material and bladed and brought to a surface cross section approximately parallel to that of the finished base. Prior to the spreading of any material for the upper course, the density tests for the lower course shall be made and shall be determined, by the engineer, that the required compaction has been obtained. After the spreading of the material for the second course is completed, its surface shall be finished and shaped so as to produce the required grade and cross section after compaction, and be free of scabs and laminations.

Moisture Content: When the material does not have the proper moisture content to insure the required density, wetting or drying will be required. When water is added, it shall be uniformly mixed-in by disking to the full depth of the course which is being compacted. Wetting or drying operations shall involve manipulation, as a unit, of the entire width and depth of the course that is being compacted.

Density Requirements: As soon as proper conditions of moisture are attained, the material shall be compacted to a density of not less than 98 percent of maximum density as determined by AASHTO T-180. The minimum density which will be acceptable at any location outside the traveled roadway (such as intersections, crossovers, turnouts, etc.) shall be 95 percent of such maximum.

TESTING SURFACE, PROTECTION, AND MAINTENANCE:

Density Tests: Density Testing shall be performed at a rate of 1 test per 100 Lineal Feet per lift. During final compacting operations, if blading of any areas is necessary to obtain the true grade and cross section, the compacting operations for such areas shall be completed prior to making the density tests on the finished base.

Correction of Defects/Contamination of Base Material: If, at any time, the subgrade material should become mixed with the base course materials, the Contractor shall, without additional compensation, dig out and remove the mixture, reshape and compact the subgrade and replace materials removed with clean base material, which shall be shaped and compacted as specified above.

Cracks and Checks: If cracks or checks appear in the base, either before or after priming, which, in the opinion of the Engineer, would impair the structural efficiency of the base, the Contractor shall remove the cracks or checks by rescarifying, reshaping, adding base material where necessary, and recompacting.

Compaction of Widening Strips: Where base construction consists of widening strips and the trench width is not sufficient to permit use of standard base compaction equipment, compaction shall be accomplished by use of vibratory compactors, trench rollers or other special equipment which will achieve the density requirements specified herein.

When multiple-course base construction is required by the plans or specifications, the required compaction shall be achieved in each course prior to spreading material for the overlaying course.

Testing Surface: The finished surface of the base course shall be checked with a template cut to the required crown and with a 15-foot straightedge laid parallel to the centerline of the road. Scarifying and removing or adding base material as required, after which the entire area shall be recompact as specified hereinbefore, shall correct all irregularities greater than 1/4 inch. In the testing of the surface, the measurements will not be taken in small holes caused by individual pieces of rock having been pulled out by the grader.

PRIMING AND MAINTAINING:

Priming: The prime coat shall be applied only when the base meets the specified density requirements and the moisture content in the top half of the base does not exceed 90 percent of the optimum moisture of the base material. At the time of priming, the base shall be firm, unyielding and in such condition that no undue distortion will occur.

Maintaining: The Contractor will be responsible for assuring that the true crown and template are maintained, with no rutting or other distortion, and that the base meets all the requirements, at the time the surface course is applied.

THICKNESS REQUIREMENTS:

Measurements: Thickness of the base shall be measured at intervals of not more than 200 feet. Measurements shall be taken at various points on the cross section, through holes not less than three inches in diameter.

Areas Requiring Correction: Where the compacted base is deficient by more than 1/2 inch from the thickness called for in the plans, the Contractor shall correct such areas by scarifying and adding rock. The base shall be scarified and rock added for a distance of 100 feet in each direction from the edge of the deficient area. The affected areas shall then be brought to the required state of compaction and to the required thickness and cross section.

TECHNICAL SPECIFICATIONS FOR GLENDALE FIRE STATION SECTION 02518-PAINTING TRAFFIC STRIPES

DESCRIPTION

The work under this Section consists of painting reflectorized traffic stripes, including edge stripes and traffic guide.

MATERIALS

Traffic Paint: The paint used shall be reflective, fast dry traffic paint as specified in 971-13 of F.D.O.T. Standard Specifications for Road and Bridge Construction, latest edition.

Glass Spheres (for Reflective Traffic Paint): Glass spheres shall conform with the requirements of 971-14 of F.D.O.T. Standard Specifications for Road and Bridge Construction, latest edition.

EQUIPMENT

General: All equipment shall be of a type and design which will readily obtain the required uniformity of application of the stripes, both as to thickness of coating and as to alignment.

Traveling Unit: The traveling unit shall be capable of traveling at a uniform, predetermined rate of speed, both uphill and downhill, in order to produce a uniform application of paint.

Paint Sprayer and Tank: The paint machine shall be of the spray type and shall be capable of spraying the paint to the required spread without thinning of the paint. The paint tank shall be equipped with a mechanical agitator. The nozzles shall have cut-off valves which will apply broken or skip lines automatically. The nozzles shall be equipped with a mechanical bead dispenser that will operate simultaneously with the spray nozzle and distribute the beads in a uniform pattern at the rate specified. Each nozzle shall also be provided with suitable line guides, either metallic shrouds or air blasts.

Corrective Devices: Misalignment, defective surfaces, etc. shall be corrected by sand blasting or by any other type of mechanical device which, in the opinion of the Engineer, will effectively remove the paint without damage to the pavement surface.

ALIGNMENT FOR STRIPES

Tack points will be established at appropriate intervals for use in aligning stripes, and if found to be necessary to achieve accuracy a stringline will be set from such points.

TOLERANCES IN DIMENSIONS AND IN ALIGNMENT

DIMENSIONS:

Longitudinal Lines: No stripe shall be less than the specified width. No stripe shall exceed the specified width by more than 2 inch. The length of the ten-foot painted segment for skip stripe, and the 30-foot gap between segments, may each vary plus or minus one foot, except that over-tolerance and under-tolerance lengths shall approximately compensate.

Transverse Markings, Gore Markings, Arrows, and Messages: When the specified width of the markings cannot be made with a single pass and multiple passes are required, the width of the line may vary by plus or minus one inch.

Alignment: On tangents, and on curves up to one degree, the alignment of the painted strip shall not deviate from the stringline by more than one inch. On curves exceeding one degree the maximum permissible deviation will be two inches. In addition, the outer edge of the edge stripe shall fall uniformly at not less than two nor more than four inches from the edge of the pavement, and shall have no noticeable breaks or deviations in alignment or width.

Correction Rates: Any corrections of variations in the width or in the alignment of the stripes shall not be made abruptly but the stripes shall be returned to the design width at the rate of at least ten feet for each 2 inch of correction, and returned to the stringline at the rate of at least 25 lineal feet per inch of correction.

APPLICATION OF PAINT AND SPHERES

Time of Application: Painting shall be done only during daylight hours and, as far as practicable, shall be terminated in time to permit sufficient drying by sunset.

Placing of permanent pavement markings on all final asphaltic concrete surfaces shall not be accomplished prior to 30 calendar days after placement of the final surfaces. Temporary pavement striping will be required during the 30 day period if the road is open to traffic.

Weather Limitations: No paint shall be applied when any moisture is present on the surface to be painted or when the air temperature is below 40EF. Painting shall not be done when winds are sufficient to cause spray dust.

Preparation of Surface to be Painted: The surface which is to be painted shall be cleaned, by compressed air or other effective means, immediately before the start of painting, and shall be clean and dry when the paint is applied. Any vegetation or loose soil shall be removed from the pavement before edge striping is begun.

Mixing Paint: The paint shall be thoroughly mixed before it is poured into the painting machine and no thinning of the paint in the machine will be allowed at any time. Before the start of each day's work the paint container, the connections, and the spray nozzles on the machine shall be thoroughly cleaned with paint thinner or other suitable cleaner.

Paint Application: The traffic stripe shall be of the specified width, with clean, true edges and without sharp breaks in the alignment. A uniform coating of paint shall be obtained and the finished stripe shall contain no light spots or paint skips. Any stripes which do not have a uniform, satisfactory appearance, both day and night, shall be corrected.

Broken Stripes: Broken (skip) stripes shall consist of a succession of solid white stripes, 10 feet in length, separated by unpainted spaces 30 feet in length.

NOTE: All pavement markings other than standard pavement markings, such as parking stripes, shall be as specified in plans.

Rate of Paint Application: The minimum rate of application for paint shall be as follows:

Four-inch solid traffic stripe: 16.5 gallons per mile.
Four-inch skip traffic stripe: 4.12 gallons per gross mile.
Any other width stripe: a direct proportion of the above.

Required Film Thickness: The minimum wet film thickness for all painted areas shall be 15 mils.

Alignment of Stripes: Where a stripe deviates from the correct alignment, as indicated by the stringline, by more than one inch in any 50-foot length, it shall be obliterated and the stripe corrected as specified in 710-3.4 of F.D.O.T. Standard Specifications.

Application of Spheres: The glass spheres shall be applied uniformly and at not less than six pound nor more than 63 pounds of spheres to each gallon of paint. The spheres shall be applied immediately following the paint application.

PROTECTION OF NEWLY PAINTED STRIPED AND OF TRAFFIC

Protection of Stripes: All newly painted stripes, including edge stripes, shall be protected until the paint is sufficiently dry to permit vehicles to cross the stripe without damage from the tires. While the center line stripes are being painted all traffic shall be routed to the right side of the painting operations and the new painted stripe. When necessary, a pilot car shall be used to protect the painting operations from traffic interference.

Protection of Traffic: Warning signs shall be set up before the beginning of each operation and extra signs shall be kept well ahead of the painting equipment. The painting equipment shall be so operated that traffic may pass on the right side safely. Warning signs are to be placed only where operations are in progress and are to be relocated as often as is necessary.

Protective Devices: The Contractor shall erect adequate warning signs, provide a sufficient number of flagmen, and take all necessary precautions for the protection of the wet paint number of flagmen, and take all necessary precautions for the protection of the wet paint and the safety of the public. Cones, rubber "Z" guards or similar protective devices shall be placed along the newly painted stripe to prevent traffic from crossing the wet paint. Any such devices used shall be of a type that will not cause damage to vehicular traffic in the event that these objects are accidentally passed over. All protective devices shall be removed not later than sunset to allow free movement of traffic at night.

If the Contractor elects to use fast dry traffic paint no protective devices will be required provided that the Contractor utilizes a trailing vehicle (behind striping machine) equipped with warning sign and flashing beacon and that he operates such vehicle in a manner consistent with the paint drying time.

Repair of Damaged Areas: Any portions of the stripes damaged by passing traffic or from any other cause shall be repainted at the Contractor's expense.

CORRECTIVE MEASURES

All painted stripes which fail to meet the specifications, including the permissible tolerances and the appearance requirements, or are marred or damaged by traffic or from other causes, shall be corrected at the Contractor's expense. All drip and spattered paint shall be removed to the satisfaction of the Engineer. Whenever it is necessary to remove paint it shall be done by means, as approved by the Engineer, which will not damage the underlying surface of the pavement. When necessary to correct a deviation which exceeds the permissible tolerance in alignment, that portion of the stripe affected shall be removed and repainted in accordance with these specifications.

ACCEPTANCE OF THE WORK

When the work under this Section has been completed to the satisfaction of the Engineer, including any corrections or repairs ordered by the Engineer, acceptance of the work painting will be made, independently of the remaining work under the Contract, and the contractor will be relieved of all maintenance of the painting except for damage due to his operations.

TECHNICAL SPECIFICATIONS FOR GLENDALE FIRE STATION

SECTION 02519-SAND-CLAY BASE

PART 1 - GENERAL

RELATED DOCUMENTS:

Drawings and general provisions of contract, including General and Supplemental Conditions, apply to the work of this section.

DESCRIPTION OF WORK:

This item shall consist of a base course composed of sand-clay constructed on a subgrade prepared in accordance with the specifications and in conformity with the line, grades and typical cross-section as shown on the drawings. The construction methods shall conform to the requirements of Section 240 of the Department of Transportation (DOT) Standards Specifications.

PART 2 - PRODUCTS

MATERIALS:

All sand-clay base materials to be used on the project road construction shall be tested by an independent laboratory to verify conformance with section 912 FDOT Road and Bridge Construction 1991 edition. The minimum LBR requirement of 75 shall be verified.

PART 3 - EXECUTION

COMPACTING AND FINISHING BASE:

General:

Double-Course Base: For the double-course base, the first course shall be cleaned of foreign material and bladed and brought to a surface cross section approximately parallel to that of the finished base. Prior to the spreading of any material for the upper course, the density tests for the lower course shall be made and shall be determined, by the engineer, that the required compaction has been obtained. After the spreading of the material for the second course is completed, its surface shall be finished and shaped so as to produce the required grade and cross section after compaction, and be free of scabs and laminations.

Moisture Content: When the material does not have the proper moisture content to insure the required density, wetting or drying will be required. When water is added, it shall be uniformly mixed-in by disking to the full depth of the course which is being compacted. Wetting or drying operations shall involve manipulation, as a unit, of the entire width and depth of the course which is being compacted.

Mixing Requirements:

After spreading the material it shall be thoroughly mixed throughout the entire width and length of roadway using an approved method of mixing. At this time a sample of material will be taken for proctor and optimum moisture content. Additional proctors may be needed whenever there is an apparent material change or as directed by Engineer.

Density Requirements:

As soon as proper conditions of moisture are attained, the material shall be compacted to a density of not less than 98 percent of maximum density as determined by AASHTO T-180. The minimum density which will be acceptable at any location outside the traveled roadway (such as intersections, crossovers, turnouts, etc.) shall be 95 percent of such maximum.

TESTING SURFACE, PROTECTION, AND MAINTENANCE:

Density Tests:

A minimum of one (1) test per 100' of roadway will be required. At least three density determinations shall be made on each days final compaction operations on each course, and the density determinations shall be made at more frequent intervals if deemed necessary by the engineer.

During final compacting operations, if blading of any area is necessary to obtain the true grade and cross section, the compacting operations for such areas shall be completed prior to making the density tests on the finished base.

At the completion of each days work the Contractor shall not leave any wind rows of material along roadway or shoulders or any obstructions that may interfere with water run off to ditches or homeowners access to their driveways.

Correction of Defects:

Contamination of Base Material: If, at any time, the subgrade material should become mixed with the base course materials, the Contractor shall, without additional compensation, dig out and remove the mixture, reshape and compact the subgrade and replace materials removed with clean base material, which shall be shaped and compacted as specified above.

Cracks and Checks: If cracks or checks appear in the base, either before or after priming, which, in the opinion of the Engineer, would impair the structural efficiency of the base, the Contractor shall remove the cracks or checks by rescarifying, reshaping, adding base material where necessary, and recompacting.

Testing Surface:

The finished surface of the base course shall be checked with a templet cut to the required crown and with a 15-foot straightedge laid parallel to the center line of the road. All irregularities greater than 1/4 inch shall be corrected by scarifying and removing or adding base material as required, after which the entire area shall be recompacted as specified herein-before.

Priming and Maintaining:

Priming: The prime coat shall be applied only when the base meets the specified density requirements and the moisture content in the top half of the base does not exceed 90 percent of the optimum moisture of the base material. At the time of priming, the base shall be firm, unyielding and in such condition that no undue distortion will occur.

Maintaining: The Contractor will be responsible for assuring that the true crown and templet are maintained, with no rutting or other distortion, and that the base meets all the requirements, at the time the surface course is applied.

Thickness Requirements:

Measurements: Thickness of the base shall be measured at intervals of not more than 200 feet. Measurements shall be taken at various points on the cross section, through holes not less than three inches in diameter.

Areas Requiring Correction: Where the compacted base is deficient by more than 1/2 inch from the thickness called for in the plans, the Contractor shall correct such areas by scarifying and adding sand-clay. The base shall be scarified and sand-clay added for a distance of 100 feet in each direction from the edge of the deficient area. The affected areas shall then be brought to the required state of compaction and to the required thickness and cross section.

**TECHNICAL SPECIFICATIONS FOR GLENDALE FIRE STATION
SECTION 02520-ASPHALT TESTING**

Test results for testing asphalt densities, thickness and mix design shall be as specified by the Florida Department of Transportation Handbook for Road and Bridge Construction (latest edition).

TESTING AND ACCEPTANCE:

All roads over 1,000 feet will require coring for in-place density and asphalt thickness. The cores will be cut at 1,000' intervals. All expenses for these tests are to be paid by the Contractor. All test results are to be turned in to Engineer before final 25% payment for road will be made. Payment will be based on the following table, with target density being 96% of mix design lab density.

| PAYMENT SCHEDULE FOR DENSITY CORES (Based on Average Density for Each Road) | |
|--|-----------------------|
| <u>PERCENT OF TARGET DENSITY</u> | <u>PERCENT OF PAY</u> |
| 98.0 and above | 100 |
| 97.0 to less than 98.0 | 95 |
| 96.0 to less than 97.0 | 90 |
| Less than 96.0* | 75 |

* If Engineer deems asphalt is acceptable to remain in place, otherwise Engineer may require removal and replacement of asphalt.

THICKNESS:

Allowable Deficiencies: The thickness shall be determined from the length of the core borings. The maximum allowable deficiency from the specified thickness shall be 1/4".

Pavement Exceeding Allowable Deficiency in Thickness:

When Deficiency is Seriously in Excess: Where the deficiency in thickness is in excess of ___ inch, for pavement of less than 2½ inches in specified thickness the Contractor shall correct the deficiency either by replacing the full thickness for a length extending at least 50 feet from each end of the deficient area, or (when permitted by the Engineer) by overlaying as directed by the Engineer.

The Contractor will receive no compensation for any pavement removed, nor for the work of removing such pavement.

When Deficiency is Not Seriously in Excess: When the deficiency in the thickness of the pavement is over ¼ inch but not more than ___ inch, for pavement of specified thickness less than 2½ inches the Contractor will be allowed to leave such pavement in place, but without compensation. The areas of such pavement for which no square yard payment will be made shall be the product of the total distance between acceptable cores, multiplied by the width of the lane which was laid at the particular pass in which deficient thickness was indicated. All costs of the overlaying and compacting shall be borne by the Contractor.

Correcting Deficiency by Adding New Surface Material: For any case of excess deficiency of the pavement, the Contractor will be permitted, if approved by the Engineer for each particular location, to correct the deficient thickness by adding new surface material and compacting to the same density as the adjacent surface. The area to be corrected and the thickness of new material added shall be as specified by Engineer. All costs of the overlaying and compacting shall be borne by the Contractor.

MIX DESIGN:

An FDOT approved mix design will be provided to the Engineer or representative prior to beginning construction, and will not change without written consent of the Engineer prior to any change.

TRUCK TICKETS:

The Contractor will provide truck tickets to the Engineer or representative on a regular basis or as requested by the Engineer.

DAILY ASPHALT PLANT TESTING:

A minimum of one extraction, gradation to be done daily, as well as test performed for stability and flow to be done on each day's production of 100 tons or more. The results of these tests are to be provided to the engineer on a weekly basis.

STRICT COMPLIANCE OF THIS SECTION WILL BE ADHERED TO

TECHNICAL SPECIFICATIONS FOR GLENDALE FIRE STATION SECTION 711- THERMOPLASTIC TRAFFIC STRIPES AND MARKINGS

711-1 Description.

Apply new thermoplastic traffic stripes and markings, or refurbish existing thermoplastic traffic stripes and markings, in accordance with the Contract Documents.

711-2 Materials.

711-2.1 Thermoplastic: Use only thermoplastic materials listed on the Qualified Products List (QPL). The Engineer will take random samples of all material in accordance with the Department's Sampling, Testing and Reporting Guide schedule.

711-2.1.1 Initial or Recapped Stripes and Markings: Use materials meeting the requirements of 971-1 and 971-5.

711-2.1.2 Refurbishing Existing Stripes and Markings: Use materials meeting the requirements of 971-1 and 971-5, or 971-6 when specifically indicated in the Contract Documents.

711-2.1.3 Preformed Stripes and Markings: Use Materials meeting the requirements of 971-1 and 971-7.

711-2.2 Glass Spheres: Use only glass spheres listed on the Qualified Products List (QPL), meeting the requirements of 971-1 and 971-2. The Engineer will take random samples of all glass spheres in accordance with ASTM D1214 and the Department's Sampling, Testing and Reporting Guide schedule.

711-2.3 Sand: Use materials meeting the requirements of 971-5.4.

711-3 Equipment.

Use equipment capable of providing continuous uniform heating of striping materials to temperatures exceeding 390°F, mixing and agitation of the material reservoir to provide a homogeneous mixture without segregation. Use equipment that will maintain the striping material in a plastic state, in all mixing and conveying parts, including the line dispensing device until applied. Use equipment which can produce varying width traffic stripes and which meets the following requirements:

(a) capable of traveling at a uniform, predetermined rate of speed, both uphill and downhill, in order to produce a uniform application of striping material and capable of following straight lines and making normal curves in a true arc.

(b) is capable of applying glass spheres to the surface of the completed stripe by a double drop application for initial traffic striping and marking and a single drop application for recapping and refurbishing. The bead dispenser for the first bead drop shall be attached to the striping machine

in such a manner that the beads are dispensed closely behind with the thermoplastic material. The second bead dispenser bead shall be attached to the striping machine in such a manner that the beads are dispensed immediately after the first bead drop application. Glass spheres dispensers shall be equipped with an automatic cut-off control that is synchronized with the cut-off of the thermoplastic material and applies the glass spheres in a manner such that the spheres appear uniform on the entire traffic stripes and markings surface with, 50 to 60% embedment.

(c) equipped with a special kettle for uniformly heating and melting the striping material. The kettle must be equipped with an automatic temperature control device and material thermometer for positive temperature control and to prevent overheating or scorching of the thermoplastic material.

(d) meet the requirements of the National Fire Protection Association, state, and local authorities.

711-4 Application.

711-4.1 General: Remove existing pavement markings such that scars or traces of removed markings will not conflict with new stripes and markings by a method approved by the Engineer.

Before applying traffic stripes and markings, remove any material by a method approved by the Engineer that would adversely affect the bond of the traffic stripes. Before applying traffic stripes to any Portland cement concrete surface, apply a primer, sealer or surface preparation adhesive of the type recommended by the manufacturer. Offset longitudinal lines at least 2 inches from any longitudinal joints of Portland cement concrete pavement.

Apply traffic stripes or markings only to dry surfaces, and when the ambient air and surface temperature is at least 50°F and rising for asphalt surfaces and 60°F and rising for concrete surfaces.

Apply striping to the same tolerances in dimensions and in alignment specified in 710-5. When applying traffic stripes and markings over existing markings, ensure that not more than 2 inches on either end and not more than 1 inch on either side of the existing line is visible.

Apply thermoplastic material to the pavement either by spray, extrusion or other means approved by the Engineer.

Conduct field tests in accordance with FM 5-541 and 5-579. Remove and replace traffic stripes and markings not meeting the requirements of this Section at no additional cost to the Department.

Apply all final pavement markings prior to opening the road to traffic.

711-4.1.1 Preformed Thermoplastic: Apply markings only to dry surfaces and when ambient air temperature is at least 32°F. Prior to installation, follow the manufacturer's recommendations for pre-heating.

711-4.2 Thickness:

711-4.2.1 Initial or Recapped Stripes and Markings: Apply or recap traffic stripes or markings such that, before application of drop-on glass spheres, all lane lines, center lines, transverse markings and traffic stripes and markings within traffic wearing areas (such as dotted turning guide lines), will have a thickness of 0.10 to 0.15 inch when measured above the pavement surface at the edge of the traffic stripe or marking.

Also, all gore, island, and diagonal stripe markings, bike lane symbols and messages, wherever located, will have a thickness of 0.09 to 0.12 inch when measured above the pavement surface at the edge of the traffic stripe or marking.

711-4.2.2 Refurbishing Existing Traffic Strips and Markings: Apply a minimum of 0.06 inch of thermoplastic material. Ensure that the combination of the existing stripe and the overlay after application of glass spheres, does not exceed the maximum thickness of 0.150 inch for all lines.

711-4.3 Retroreflectivity: Apply white and yellow traffic stripes and markings that will attain an initial retroreflectivity of not less than $450 \text{ mcd/lx}\cdot\text{m}^2$ and not less than $350 \text{ mcd/lx}\cdot\text{m}^2$, respectively for all longitudinal lines. All transverse lines, messages and arrows will attain an initial retroreflectivity of not less than $300 \text{ mcd/lx}\cdot\text{m}^2$ and $250 \text{ mcd/lx}\cdot\text{m}^2$ for white and yellow respectively. All pedestrian crosswalks, bike lane symbols or messages in a proposed bike lane shall attain an initial retroreflectivity of not less than $275 \text{ mcd/lx}\cdot\text{m}^2$.

Measure, record and certify on Department approved form and submit to the Engineer, the retroreflectivity of white and yellow pavement markings in accordance with Florida Method FM-5-579.

The Department reserves the right to test the markings within three days of receipt of the Contractor's certification. The test readings should be representative of the Contractor's striping performance. If the retroreflectivity values measure below values shown above, the striping will be removed and reapplied at the Contractor's expense.

711-4.4 Color: Use thermoplastic material that meets the requirements of 971-1.

711-4.5 Glass Spheres:

711-4.5.1 Longitudinal Lines: For initial traffic striping and marking, apply the first drop of Type 4 or larger glass spheres immediately followed by the second drop of Type 1 glass spheres. For refurbishing, apply a single drop of Type 3 glass spheres. Apply reflective glass spheres to all markings at the rates determined by the manufacturer's recommendations.

711-4.5.2 Transverse Stripes and Markings: Apply a single drop of Type 1 glass spheres. Apply reflective glass spheres to all markings at the rates determined by the manufacturer's recommendations.

Apply a mixture consisting of 50% glass spheres and 50% sharp silica sand to all thermoplastic pedestrian crosswalk lines and bike lane symbols at the rates determined by the manufacturer's recommendations.

711-4.5.3 Preformed Markings: These markings are factory supplied with glass spheres and skid resistant material. No additional glass spheres or skid resistant material should be applied during installation.

711-5 Contractor's Responsibility for Notification.

Notify the Engineer prior to the placement of the thermoplastic materials. Furnish the Engineer with the manufacturer's name and LOT numbers of the thermoplastic materials and glass spheres to be used. Ensure that the approved LOT numbers appear on the thermoplastic materials and glass spheres packages. Submit a certified test report to the Engineer indicating that the striping materials meet all requirements specified.

711-6 Protection of Newly Applied Traffic Stripes And Markings.

Do not allow traffic onto or permit vehicles to cross newly applied pavement markings until they are sufficiently dry. Remove and replace any portion of the pavement markings damaged by passing traffic or from any other cause, at no additional cost to the Department

711-7 Observation Period.

Pavement markings are subject to a 180 day observation period under normal traffic. The observation period shall begin with the satisfactory completion and acceptance of the work.

The pavement markings shall show no signs of failure due to blistering, excessive cracking, chipping, discoloration, poor adhesion to the pavement, loss of reflectivity or vehicular damage. The Department reserves the right to check the color and retroreflectivity within 30 days prior to the end of the observation period.

Replace, at no additional expense to the Department, any pavement markings that do not perform satisfactorily under traffic during the 180 day observation period.

711-8 Corrections for Deficiencies.

Recapping applies to conditions where additional striping material is applied to new or refurbished traffic stripes or markings to correct a deficiency. Recap a 1.0 mile LOT centered around the deficiency with additional striping material or by complete removal and reapplication at no additional cost to the Department.

If recapping will result in a thickness exceeding the maximum allowed, the traffic stripes or markings will be removed and reapplied.

711-9 Method of Measurement.

The quantities to be paid for under this Section will be as follows:

- (a) The net length, in feet, of each of the various types of lines and stripes, authorized and acceptably applied.
- (b) The total traversed distance in gross miles of 10-30 skip line. The actual applied line is 25% of the traverse distance for a 1:3 ratio. This equates to 1,320 feet of marking per mile of single line.
- (c) The length, in net miles, of Solid Traffic Stripe, authorized and acceptably applied.
- (d) The area, in square feet, of Removal of Existing Pavement Markings, acceptably removed.
- (e) The number of pavement messages, symbols and directional arrows, authorized and acceptably applied.

711-10 Basis of Payment.

Prices and payments will be full compensation for all work specified in this Section, including, all cleaning and preparing of surfaces, furnishing of all materials, application, curing and protection of all items, protection of traffic, furnishing of all tools, machines and equipment, and all incidentals necessary to complete the work. Final payment will be withheld until all deficiencies are corrected.

Payment will be made under:

- Item No. 711 Thermoplastic
- Traffic Stripes, Solid - per net mile.
- Traffic Stripes, Solid - per foot.
- Traffic Stripes, Skip - per gross mile.
- Traffic Stripes, Skip - per foot.
- Dotted/Guideline - per foot.
- Messages - each.
- Arrows - each.
- Yield Markings - per foot.

**TECHNICAL SPECIFICATIONS FOR GLENDALE BEACH FIRE STATION
SECTION 03310-CONCRETE WORK**

PART 1 - GENERAL

RELATED DOCUMENTS:

Drawings and general provisions of Contract, including General and Special Conditions, apply to work of this section.

DESCRIPTION OF WORK:

Extent of concrete work is shown on Drawings.

SUBMITTALS:

PRODUCT DATA: Submit data proprietary materials and items, including reinforcement and forming accessories, admixtures, patching compounds, waterstops, joint systems, curing compounds, dry-shake finish materials, and others as requested by Engineer.

SHOP DRAWINGS, REINFORCEMENT: Submit original shop drawings for fabrication, bending, and placement of concrete reinforcement. Comply with ACI 315 "Manual of Standard Practice for Detailing Reinforced Concrete Structures" showing bar schedules, stirrup spacing, diagrams of bent bars, arrangement of concrete reinforcement. Include special reinforcement required for openings through concrete structures.

Engineer's review is for general engineering applications and features only. Design of formwork for structural stability and efficiency is Contractor's responsibility.

LABORATORY TEST REPORTS: Submit laboratory test reports for concrete materials and mix design test.

QUALITY ASSURANCE:

CODES AND STANDARDS: Comply with provisions of following codes, specifications, and standards, except where more stringent requirements are shown or specified:

- *ACI 301* "Specifications for Structural Concrete for Buildings".
- *ACI 318* "Building Code Requirements for Reinforced Concrete".
A Concrete Reinforcing Steel Institute (CRSI) "Manual of Standard Practice".

CONCRETE TESTING SERVICES: Engage a testing laboratory acceptable to Engineer to perform material evaluation tests and to design concrete mixes.

Materials and installed work may require testing and retesting at anytime during progress of work.

Tests, including retesting of rejected materials for installed work, shall be done at Contractor's

expense.

PROJECT CONDITIONS:

PROTECTION OF FOOTINGS AGAINST FREEZING: Cover completed work at footing level with sufficient temporary or permanent cover as required to protect footings and adjacent subgrade against possibility of freezing; maintain cover for time period as necessary.

Protect adjacent finish materials against spatter during concrete placement.

PART 2 - PRODUCTS

FORM MATERIALS:

FORMS FOR EXPOSED FINISH CONCRETE: Plywood, metal, metal-framed plywood faced, or other acceptable panel-type materials, to provide continuous, straight, smooth, exposed surfaces. Furnish in largest practicable sizes to minimize number of joints.

Use plywood complying with U. S. Product Standard PS-1 "B-B (Concrete Form) Plywood", Class I, Exterior Grade or better, mill-oiled and edge-sealed, with each piece bearing legible inspection trademark.

FORMS FOR UNEXPOSED FINISH CONCRETE: Plywood, lumber, metal, or other acceptable material. Provide lumber dressed on at least 2 edges and one side for tight fit.

FORM COATINGS: Provide commercial formulation form-coating compounds that will not bond with, stain, nor adversely affect concrete surfaces, and will not impair subsequent treatments of concrete surfaces.

FORM TIES: Factory-fabricated, adjustable-length, removable or snap off metal form ties, designed to prevent form deflection and to prevent spalling concrete upon removal. Provide units which will leave no metal closer than 1-1/2" to surface.

Provide ties which, when removed, will leave holes not larger than 1" diameter in concrete surface.

REINFORCING MATERIALS:

Reinforcing Bars: ASTM A 615, Grade 60, deformed.

Steel Wire: ASTM A 82, plain, cold-drawn steel.

Welded Wire Fabric: ASTM A 185, welded steel wire fabric.

Welded Deformed Steel Wire Fabric: ASTM A 497.

Supports for Reinforcement: Bolsters, chairs, spacers, and other devices for spacing, supporting, and fastening reinforcing bars and welded wire fabric in place. Use wire bar type supports complying with CRSI specifications.

For slabs-on-grade, use supports with sand plates or horizontal runners where base material will not support chair legs.

CONCRETE MATERIALS:

PORTLAND CONCRETE: ASTM C 150, Type I.

Use one brand of cement throughout project, unless otherwise acceptable to Engineer.

NORMAL WEIGHT AGGREGATES: ASTM C 33, and as herein specified. Provide aggregates from a single source for exposed concrete.

For exterior exposed surfaces, do not use fine or coarse aggregates containing spalling-causing deleterious substances.

WATER: Drinkable.

RELATED MATERIALS:

POLYVINYL CHLORIDE WATERSTOPS: Corps of Engineers CRD-C 572.

AVAILABLE MANUFACTURERS: Subject to compliance with requirements, manufacturers offering products which may be incorporated in the work include, but are not limited to, the following:

Manufacturer: Subject to compliance with requirements, provide products of one of the following or equal:

- AFCO Products
- The Burke Co.
- Edoco Technical Products
- Greenstreet Plastic Products
- Harbour Town Products
- W. R. Meadows
- Progress Unlimited
- Schleigel Corp.
- Vinylex Corp.

Granular Base: Evenly graded mixture of fine and coarse aggregates to provide, when compacted, a smooth and even surface below slabs on grade.

Vapor Retarder: Provide vapor retarder cover over prepared base material where indicated below

slabs on grade. Use only materials which are resistant to decay when tested in accordance with ASTM E 154, as follows:

- Polyethylene sheet not less than 8 mils thick.
- Non-Shrink Grout: CRD-C 621, factory pre-mixed grout.
- Products: Subject to compliance with requirements, provide one of the following or equal

Metallic:

- "Vibrofoil", A. C. Horn, Inc.
- "Metallic Spec. Grout", The Burke Co.
- "Embeco 636", Master Builders
- "AFerrolith GDS", Sonneborn-Rexnord
- "Hi-Mod Grout", Euclid Chemical Co.
- "Kemox G", Sika Chemical Co.
- "Merrogrout", L & M Const. Chemical Co.
- "Supreme Plus", Gifford-Hill/American Admixtures

Non-metallic:

- "Set Grout", Master Builders
- "Sonogrout", Sonneborn-Rexnord
- "Euco-NS", Euclid Chemical Co.
- "Supreme", Gifford-Hill/American Admixtures
- "Crystex", L & M Const. Chemical Co.
- "Sure-Grip Grout", Dayton Superior Corp.
- "Horngrout", A. C. Horn, Inc.
- "Five Star Grout", U. S. Grout Corp.

Liquid Membrane-forming Curing Compound: Liquid type membrane-forming curing compound complying with ASTM C 309, Type I, Class A. Moisture loss not more than 0.055 gr./sq. cm. when applied at 200 sq. ft./gal.

Products: Subject to compliance with requirements, provide one of the following or equal:

- "Masterseal", Master Builders
- "A-H 3 Way Sealer", Anti-Hydro Waterproofing Co.
- "Ecocure", Euclid Chemical Co.
- "Clear Seal", A. C. Horn, Inc.
- "Sealco 309", Gifford-Hill/American Admixtures
- "J-20 Acrylic Cure", Dayton Superior
- "Spartan-Cote", The Burke Co.
- "Sealkure", Toch Div. – Carboline
- "Kure-N-Seal", Sonneborn-Rexnord
- "Polyclear", Upco Chemical/USM Corp.
- "L & M Cure", L & M Construction Chemicals
- "Klearseal", Setcon Industries

- "LR-152", Protex Industries
- "Hardtop", Gifford-Hill

PROPORTIONING AND DESIGN OF MIXES:

Prepare design mixes for each type and strength of concrete by either laboratory trial batch or field experience methods as specified in ACI 301. If trial batch method used, use an independent testing facility acceptable to Engineer for preparing and reporting proposed mix designs. The testing facility shall not be the same as used for field quality control testing.

Submit written reports to Structural Engineer of each proposed mix for each class of concrete at least 15 days prior to start of work. Do not begin concrete production until mixes have been reviewed by Engineer.

Design mixes to provide normal weight concrete with the following properties, as indicated on drawings and schedules:

- 4000 psi 28-day compressive strength; W/C ratio, 0.44 maximum (non-air-entrained).
- 3000 psi 28-day compressive strength; W/C ratio, 0.58 maximum (non-air-entrained).
- 2500 psi 28-day compressive strength; W/C ratio, 0.67 maximum (non-air-entrained).

LIGHTWEIGHT CONCRETE: Proportion mix as herein specified. Design mix to produce strength and modulus of elasticity as noted on Drawings, with a split-cylinder strength factor (F_{ct}) of not less than 5.5 for 3000 psi concrete and a dry weight of not less than 95 lbs. or more than 110 lbs. after 28 days. Limit shrinkage to 0.03 percent at 28 days.

ADJUSTMENT TO CONCRETE MIXES: Mix design adjustments may be requested by Contractor when characteristics of materials, job conditions, weather, test results, or other circumstances warrant; at no additional cost to Owner and as accepted by Engineer. Laboratory test data for revised mix design and strength results must be submitted to and accepted by Engineer before using in work.

Use air-entraining admixture in exterior exposed concrete, unless otherwise indicated. Add air-entraining admixture at manufacturer's prescribed rate to result in concrete at point of placement having total air content with a tolerance of plus-or-minus 1-1/2 percent within following limits:

SLUMP LIMITS: Proportion and design mixes to result in concrete slump at point of placement as follows:

- Ramps, slabs, and sloping surfaces: Not more than 3 inches.
- Reinforced foundation systems: Not less than 1 inch and not more than 3 inches.
- Concrete containing HRWR admixture (super-plasticizer): Not more than 8 inches after addition of HRWR to site-verified 2-3 inches slump concrete.
- Other concrete: Not less than 1 inch nor more than 4 inches.

CONCRETE MIXING:

READY-MIX CONCRETE: Comply with requirements of ASTM C 94, and as herein specified.

During hot weather, or under conditions contributing to rapid setting of concrete, a shorter mixing time than specified in ASTM C 94 may be required.

PART 3 - EXECUTION

GENERAL:

Coordinate the installation of joint materials and vapor retarders with placement of forms and reinforcing steel.

FORMS:

Design, erect, support, brace, and maintain formwork to support vertical and lateral, static, and dynamic loads that might be applied until such loads can be supported by concrete structure. Construct formwork so concrete members and structures are of correct size, shape, alignment, elevation, and position. Maintain formwork construction tolerances complying with ACI 347.

Design formwork to be readily removable without impact, shock, or damage to cast-in-place concrete surfaces and adjacent materials.

Construct forms to sizes, shapes, lines, and dimensions shown, and to obtain accurate alignment, location, grades, level and plumb work in finished structures. Provide for openings, offsets, sinkages, keyways, recesses, moldings, rustications, reglets, chamfers, blocking, screeds, bulkheads, anchorages and inserts, and other features required to work. Use selected materials to obtain required finishes. Solidly butt joints and provide back-up at joints to prevent leakage of cement paste.

Fabricate forms for easy removal without hammering or prying against concrete surfaces. Provide crush plates or wrecking plates where stripping may damage cast concrete surfaces. Provide top forms for inclined surfaces where slope is too steep to place concrete with bottom forms only. Kerf wood inserts for forming keyways, reglets, recesses, and the like, to prevent swelling and for easy removal.

Provide temporary openings where interior area of formwork is inaccessible for cleanout, for inspection before concrete placement, and for placement of concrete. Securely brace temporary openings and set tightly to forms to prevent loss of concrete mortar. Locate temporary openings on forms at inconspicuous locations.

Chamfer exposed corners and edges as indicated, using wood, metal, PVC, or rubber chamfer strips fabricated to produce uniform smooth lines and tight edge joints.

Provisions for Other Trades: Provide openings in concrete formwork to accommodate work of other trades. Determine size and location of openings, recesses, and chases from trades providing such

items. Accurately place and securely support items built into forms. Other trades shall provide location and size of openings. The forms for such openings shall be constructed and set in place under this section.

Cleaning and Tightening: Thoroughly clean forms and adjacent surfaces to receive concrete. Remove chips, wood, sawdust, dirt, or other debris just before concrete is placed. Retightening forms and bracing after concrete placement is required to eliminate mortar leaks and maintain proper alignment.

VAPOR RETARDER INSTALLATION:

Following leveling and tamping of granular base for slabs on grade, place vapor retarder sheeting with longest dimension parallel with direction of pour.

Lap joints 6" and seal with appropriate tape.

PLACING REINFORCEMENT:

Comply with Concrete Reinforcing Steel Institute's recommended practice for "Placing Reinforcing Bars", for details and methods of reinforcement placement and supports, and as herein specified.

Avoid cutting or puncturing vapor retarder during reinforcement placement and concreting operations.

Clean reinforcement of loose rust and mill scale, earth, ice, and other materials which reduce or destroy bond with concrete.

Accurately position, support, and secure reinforcement against displacement by formwork, construction, or concrete placement operations. Locate and support reinforcing by metal chairs, runners, bolsters, spacers, and hangers, as required.

Place reinforcement to obtain at least minimum coverages for concrete protection. Arrange, space, and securely tie bars and bar supports to hold reinforcement in position during concrete placement operations. Set wire ties so ends are directed into concrete, not toward exposed concrete surfaces.

Install welded wire fabric in as long lengths as practicable. Lap adjoining pieces at least one full mesh and lace splices with wire. Offset end laps in adjacent widths to prevent continuous laps in either direction.

JOINTS:

CONSTRUCTION JOINTS: Locate and install construction joints as indicated or, if not indicated, locate so as not to impair strength and appearance of the structure, as acceptable to Engineer.

Place construction joints perpendicular to main reinforcement. Continue reinforcement across

construction joints, except as otherwise indicated.

WATERSTOPS: Provide waterstops in construction joints as indicated. Install waterstops to form continuous diaphragm in each joint. Make provisions to support and protect exposed waterstops during progress of work. Fabricate field joints in waterstops in accordance with manufacturer's printed instructions.

ISOLATION JOINTS IN SLABS-ON-GROUND: Construct isolation joints in slabs-on-ground at points of contact between slabs-on-ground and vertical surfaces, such as column pedestals, foundation walls, grade beams, and elsewhere as indicated.

INSTALLATION OF EMBEDDED ITEMS:

GENERAL: Set and build into work anchorage devices and other embedded items required for other work that is attached to, or supported by, cast-in-place concrete. Use setting drawings, diagrams, instructions, and directions provided by suppliers of items to be attached thereto.

PREPARATION OF FORM SURFACES:

Clean re-used forms of concrete matrix residue, repair and patch as required to return forms to acceptable surface condition.

Coat contact surfaces of forms with a form-coating compound before reinforcement is placed.

Thin form-coating compounds only with thinning agent of type, amount, and under conditions of form-coating compound manufacturer's directions. Do not allow excess form-coating material to accumulate in forms or to come into contact with in-place concrete surfaces against which fresh concrete will be placed. Apply in compliance with manufacturer's instructions.

CONCRETE PLACEMENT:

PREPLACEMENT INSPECTION: Before placing concrete, inspect and complete formwork installation, reinforcing steel, and items to be embedded or cast-in. Notify other crafts to permit installation of their work; cooperate with other trades in setting such work. Moisten wood forms immediately before placing concrete where form coatings are not used.

Apply temporary protective covering to lower 2' of finished walls adjacent to poured floor slabs and similar conditions, and guard against spattering during placement.

GENERAL: Comply with ACI 304 "Recommended Practice for Measuring, Mixing, Transporting, and Placing Concrete", and as herein specified.

Deposit concrete continuously or in layers of such thickness that no concrete will be placed on concrete which has hardened sufficiently to cause the formation of seams or planes of weakness. If a section cannot be placed continuously, provide construction joints as herein specified. Deposit

concrete as nearly as practicable to its final location to avoid segregation.

PLACING CONCRETE IN FORMS: Deposit concrete in forms in horizontal layers not deeper than 24 inches and in a manner to avoid inclined construction joints. Where placement consists of several layers, place each layer while preceding layer is still plastic to avoid cold joints.

Consolidate placed concrete by mechanical vibrating equipment supplemented by hand-spading, rodding, or tamping. Use equipment and procedures for consolidation of concrete in accordance with ACI 309.

Do not use vibrators to transport concrete inside forms. Insert and withdraw vibrators vertically at uniformly spaced locations not farther than visible effectiveness of machine. Place vibrators to rapidly penetrate placed layer and at least 6 inches into preceding layer. Do not insert vibrators into lower layers of concrete that have begun to set. At each insertion limit duration of vibration to time necessary to consolidate concrete and complete embedment of reinforcement and other embedded items without causing segregation of mix.

PLACING CONCRETE SLABS: Deposit and consolidate concrete slabs in a continuous operation, within limits of construction joints, until the placing of a panel or section is completed.

Consolidate concrete during placing operations so that concrete is thoroughly worked around reinforcement and other embedded items and into corners.

Bring slab surfaces to correct level with straightedge and strikeoff. Use bull floats or darbies to smooth surface, free of humps or hollows. Do not disturb slab surfaces prior to beginning finishing operations.

Maintain reinforcing in proper position during concrete placement operations.

COLD WEATHER PLACING: Protect concrete work from physical damage or reduced strength which could be caused by frost, freezing actions, or low temperatures, in compliance with ACI 306 and as herein specified.

When air temperature has fallen to or is expected to fall below 40 degrees F (4 degrees C), uniformly heat water and aggregates before mixing to obtain a concrete mixture temperature of not less than 50 degrees F (10 degrees C), and not more than 80 Degrees F (27 degrees C) at point of placement.

Do not use frozen materials or materials containing ice or snow. Do not place concrete on frozen subgrade or on subgrade containing frozen materials.

Do not use calcium chloride, salt, and other materials containing antifreeze agents or chemical accelerators, unless otherwise accepted in mix designs.

HOT WEATHER PLACING: When hot weather conditions exist that would seriously impair quality and strength of concrete, place concrete in compliance with ACI 305 and as herein specified.

Cool ingredients before mixing to maintain concrete temperature at time of placement below 90 degrees F (32 degrees C). Mixing water may be chilled, or chopped ice may be used to control

temperature provided water equivalent of ice is calculated to total amount of mixing water. Use of liquid nitrogen to cool concrete is Contractor's option.

Cover reinforcing steel with water-soaked burlap if it becomes too hot, so that steel temperature will not exceed the ambient air temperature immediately before embedment in concrete. Fog spray forms, reinforcing steel, and subgrade just before concrete is placed.

Use water-reducing retarding admixture (Type D) when required by high temperatures, low humidity, or other adverse placing conditions.

FINISH OF FORMED SURFACES:

ROUGH FORM FINISH: For formed concrete surfaces not exposed-to-view in the finish work or by other construction, unless otherwise indicated. This is the concrete surface having texture imparted by form facing material used, with tie holes and defective areas repaired and patched and fins and other projections exceeding 1/4 inch in height rubbed down or chipped off.

SMOOTH FORM FINISH: For formed concrete surfaces exposed-to-view, or that are to be covered with a coating material applied directly to concrete, or a covering material applied directly to concrete, such as waterproofing, dampproofing, veneer plaster, painting, or other similar system. This is as-cast concrete surface obtained with selected form facing material, arranged orderly and symmetrically with a minimum of seams. Repair and patch defective areas with fins or other projections completely removed and smoothed.

GROUT CLEANED FINISH: Provide grout cleaned finish to scheduled concrete surfaces which have received smooth form finish treatment.

Combine one part Portland cement to 1-1/2 parts fine sand by volume, and mix with water to consistency of thick paint. Proprietary additives may be used at Contractor's option. Blend standard portland cement and white portland cement, amounts determined by trial patches, so that final color of dry grout will match adjacent surfaces.

Thoroughly wet concrete surfaces and apply grout to coat surfaces and fill small holes. Remove excess grout by scraping and rubbing with clean burlap. Keep damp by fog spray for at least 36 hours after rubbing.

RELATED UNFORMED SURFACES: At tops of walls, horizontal offsets, and similar unformed surfaces occurring adjacent to formed surfaces, strike-off smooth and finish with a texture matching adjacent formed surfaces. Continue final surface treatment of formed surfaces uniformly across adjacent unformed surfaces, unless otherwise indicated.

MONOLITHIC SLAB FINISHES:

ASTM E 1155, "Standard Test Method for Determining Floor Flatness and Levelness Using the "F Number System (inch-pound-units)", shall be used for these finishes as follows:

SCRATCH FINISH: Apply scratch finish to monolithic slab surfaces that are to receive concrete floor topping or mortar setting beds for tile, portland cement terrazzo, and other bonded applied cementitious finish flooring material, and as otherwise indicated.

After placing slabs, plane surface to tolerances for floor flatness (FF) of 15 and floor levelness (FL) of 13. Slope surfaces uniformly to drains where required. After leveling, roughen surface before final set, with stiff brushes, brooms, or rakes.

FLOAT FINISH: Apply float finish to monolithic slab surface to receive trowel finish and other finishes as hereinafter specified, and slab surfaces which are to be covered with membrane or elastic waterproofing membrane or elastic roofing, or sand-bed terrazzo, and as otherwise indicated.

After screeding, consolidating, and leveling concrete slabs, do not work surface until ready for floating. Begin floating when surface water has disappeared or when concrete has stiffened sufficiently to permit operation of power-driven floats, or both. Consolidate surface with power-driven floats, or by hand-floating if area is small or inaccessible to power units. Check and level surface plane to tolerances of FF 18 - FL 15. Cut down high spots and fill low spots. Uniformly slope surfaces to drains. Immediately after leveling, refloat surface to a uniform, smooth, granular texture.

TROWEL FINISH: Apply trowel finish to monolithic slab surfaces to be exposed-to-view, and slab surfaces to be covered with resilient flooring, carpet, ceramic or quarry tile, paint, or other thin film finish coating system.

After floating, begin first trowel finish operation using a power-driven trowel. Begin final troweling when surface produces a ringing sound as trowel is moved over surface. Consolidate concrete surface by final hand-troweling operation, free of trowel marks, uniform in texture and appearance, and with surface leveled to tolerances of FF 20 - FL 17. Grind smooth surface defects which would telegraph through applied floor covering system.

TROWEL AND FINE BROOM FINISH: Where ceramic or quarry tile is to be installed with thin-set mortar, apply trowel finish as specified, then immediately follow with slightly scarifying surface by fine brooming.

NON-SLIP BROOM FINISH: Apply non-slip broom finish to exterior concrete platforms, steps, and ramps, and elsewhere as indicated.

Immediately after float finishing, slightly roughen concrete surface by brooming with fiber bristle broom perpendicular to main traffic route. Coordinate required final finish with Engineer before application.

CONCRETE CURING AND PROTECTION:

GENERAL: Protect freshly placed concrete from premature drying and excessive cold or hot temperatures.

Start initial curing as soon as free water has disappeared from concrete surface after placing and finishing. Weather permitting, keep continuously moist for not less than 7 days.

Begin final curing procedures immediately following initial curing and before concrete has dried. Continue final curing for at least 7 days in accordance with ACI 301 procedures. Avoid rapid drying at end of final curing period.

CURING METHODS: Perform curing of concrete by curing and sealing compound, by moist curing, by moisture-retaining cover curing, and by combinations thereof, as herein specified.

Provide moisture curing by the following methods:

- Keep concrete surface continuously wet by covering with water.
- Continuous water-fog spray.
- Covering concrete surface with specified absorptive cover, thoroughly saturating cover with water and keeping continuously wet. Place absorptive cover to provide coverage of concrete surfaces and edges, with 4 inch lap over adjacent absorptive covers.

Provide moisture-cover curing as follows:

- Cover concrete surfaces with moisture-retaining cover for curing concrete, placed in widest practicable width with sides and ends lapped at least 3 inches and sealed by waterproof tape of adhesive. Immediately repair any holes or tears during curing period using cover material and waterproof tape.

Provide curing slabs and sealing compounds to exposed interior slabs and to exterior slabs, walks, and curbs, as follows:

- Apply specified curing and sealing compound to concrete slabs as soon as final finishing operations are complete (within 2 hours). Apply uniformly in continuous operation by power-spray or roller in accordance with manufacturer's directions. Recoat areas subjected to heavy rainfall within 3 hours after initial application. Maintain continuity of coating and repair damage during curing period.

Do not use membrane curing compounds on surfaces which are to be covered with coating material applied directly to concrete, liquid floor hardener, waterproofing, dampproofing, membrane roofing, flooring (such as ceramic or quarry tile, glue-down carpet), painting, and other coatings and finish materials, unless otherwise acceptable to Engineer.

Curing Formed Surfaces: Cure formed concrete surfaces, including undersides of beams, supported slabs, and other similar surfaces by moist curing with forms in place for full curing period or until forms are removed. If forms are removed, continue curing by methods specified above, as applicable.

CURING UNFORMED SURFACES: Cure unformed surfaces, such as slabs, floor topping, and other flat surfaces by application of appropriate curing method.

Final cure concrete surfaces to receive liquid floor hardener or finish flooring by use of moisture-retaining cover, unless otherwise directed.

SEALER AND DUSTPROOFER: Apply a second coat of specified curing and sealing compound only to surfaces given a first coat.

SHORES AND SUPPORTS:

Remove shoring from ground to roof for structures 4 stories or less, unless otherwise permitted.

Remove shores and reshore in a planned sequence to avoid damage to partially cured concrete. Locate and provide adequate reshoring to safely support work without excessive stress or deflection.

Keep shores in place a minimum of 15 days after placing upper tier, and longer if required, until concrete has attained its required 28-day strength and heavy loads due to construction operations have been removed.

REMOVAL OF FORMS:

Formwork not supporting weight of concrete, such as sides of beams, walls, columns, and similar parts of the work, may be removed after cumulatively curing at not less than 50 degrees F (10 degrees C) for 24 hours after placing concrete, provided concrete is sufficiently hard to not be damaged by form removal operations, and provided curing and protection operations are maintained.

Form facing material may be removed 4 days after placement, only if shores and other vertical supports have been arranged to permit removal of form facing material without loosening or disturbing shores and supports.

RE-USE OF FORMS:

Clean and repair surfaces of forms to be re-used in work. Split, frayed, delaminated, or otherwise damaged from facing material will not be acceptable for exposed surfaces. Apply new form coating compound as specified for new formwork.

When forms are extended for successive concrete placement, thoroughly clean surfaces, remove fins and laitance, and tighten forms to close joints. Align and secure joint to avoid offsets. Do not use "patched" forms for exposed concrete surfaces, except as acceptable to Engineer.

MISCELLANEOUS CONCRETE ITEMS:

FILLING-IN: Fill-in holes and openings left in concrete structures for passage of work by other trades, unless otherwise shown or directed, after work of other trades is in place. Mix, place, and cure concrete as herein specified, to blend with in-place construction. Provide other miscellaneous concrete filling shown or required to complete work.

CURBS: Provide monolithic finish to interior curbs by stripping forms while concrete is still green and steel troweling surfaces to a hard, dense finish with corners, intersections, and terminations slightly rounded.

EQUIPMENT BASES AND FOUNDATIONS: Provide machine and equipment bases and foundations, as shown on drawings. Set anchor bolts for machines and equipment to template at correct elevations, complying with certified diagrams or templates of manufacturer furnishing machines and equipment.

Grout base plates and foundations as indicated, using specified non-shrink grout. Use non-metallic grout for exposed conditions, unless otherwise indicated.

REINFORCED MASONRY: Provide concrete grout for reinforced masonry lintels and bond beams where indicated on drawings and as scheduled including filling of concrete modular unit cavities where called for on plans. Maintain accurate location of reinforcing steel during concrete placement.

CONCRETE SURFACE REPAIRS:

PATCHING DEFECTIVE AREAS: Repair and patch defective areas with cement mortar immediately after removal of forms, when acceptable to Engineer.

Cut out honeycomb, rock pockets, voids over 1/4 inch in any dimension, and holes left by tie rods and bolts, down to solid concrete but, in no case to a depth of less than 1 inch. Make edges of cuts perpendicular to the concrete surface. Thoroughly clean, dampen with water, and brush-coat the area to be patched with specified bonding agent. Place patching mortar after bonding compound has dried.

REPAIR OF FORMED SURFACES: Remove and replace concrete having defective surfaces if defects cannot be repaired to satisfaction of Engineer. Surface defects, as such, include color and texture irregularities, cracks, spalls, air bubbles, honeycomb, rock pockets; fins and other projections on surface; and stains and other discolorations that cannot be removed by cleaning. Flush out form tie holes, fill with dry pack mortar, or precast cement cone plugs secured in place with bonding agent.

Repair concealed formed surfaces, where possible, that contain defects that affect the durability of concrete. If defects cannot be repaired, remove and replace concrete.

REPAIR OF UNFORMED SURFACES: Test unformed surfaces, such as monolithic slabs, for smoothness and verify surface plane to tolerances specified for each surface and finish. Correct low and high areas as herein specified. Test unformed surfaces slopped to drain for trueness of slope, in addition to smoothness using a template having required slope.

Repair finished unformed surfaces that contain defects which affect durability of concrete. Surface defects, as such, include crazing cracks in excess of 0.01 inch wide or which penetrate to

reinforcement or completely through non-reinforced sections regardless of width, spalling, pop-outs, honeycomb, rock pockets, and other objectionable conditions.

Correct high areas in unformed surfaces by grinding, after concrete has cured at least 14 days.

Correct low areas in unformed surfaces during or immediately after completion of surface finishing operations by cutting out low areas and replacing with fresh concrete. Finish repaired areas to blend into adjacent concrete. Proprietary patching compounds may be used when acceptable to Engineer.

Repair defective areas, except random cracks and single holes not exceeding 1 inch diameter, by cutting out and replacing with fresh concrete. Remove defective areas to sound concrete with clean, square cuts and expose reinforcing steel with at least 3/4 inch clearance all around. Dampen concrete surfaces in contact with patching concrete and apply bonding compound. Mix patching concrete of same materials to provide concrete of same type or class as original concrete. Place, compact, and finish to blend with adjacent finished concrete. Cure in same manner as adjacent concrete.

Perform structural repairs with prior approval of Structural Engineer for method and procedure, using specified epoxy adhesive and mortar.

Repair methods not specified above may be used, subject to acceptance of Engineer.

QUALITY CONTROL TESTING DURING CONSTRUCTION:

The Owner will employ a testing laboratory to perform tests and to submit test reports.

Sampling and testing for quality control during placement of concrete may include the following, as directed by Engineer.

SAMPLING FRESH CONCRETE: ASTM C 172, except modified for slump to comply with ASTM C 94.

SLUMP: ASTM C 143, one test at point of discharge for each day's pour of each type of concrete, and additional tests when concrete consistency seems to have changed.

Concrete Temperature: Test hourly when air temperature is 40 degrees F (4 degrees C) and below, and when 80 degrees F (27 degrees C) and above, and each time a set of compression test specimens are made.

COMPRESSION TEST SPECIMEN: ASTM C 31, one set of 4 standard cylinders for each compressive strength test, unless otherwise directed. Mold and store cylinders for laboratory cured test specimens except when field-cure test specimens are required.

COMPRESSIVE STRENGTH TESTS: ASTM C 39, one set for each day's pour exceeding 5 cubic yards plus additional sets for each 50 cubic yards over and above the first 25 cubic yards of each concrete class placed in any one day; one specimen tested at 7 days, two specimens tested at 28 days, and one specimen retained in reserve for later testing if required.

When frequency of testing will provide less than 5 strength tests for a given class of concrete, conduct testing from at least 5 randomly selected batches or from each batch if fewer than 5 are used.

Test results will be reported in writing to Structural Engineer and Contractor within 24 hours after tests. Reports of compressive strength tests shall contain the project identification name and number, date of concrete placement, name of concrete testing service, concrete type and class, location of concrete batch in structure, design compressive strength at 28 days, concrete mix proportions and materials; compressive breaking strength and type of break for both 7-day tests and 28-day tests.

NONDESTRUCTIVE TESTING: Impact hammer, sonoscope, or other nondestructive device may be permitted but shall not be used as the sole basis for acceptance or rejection.

ADDITIONAL TESTS: The testing service will make additional tests of in-place concrete when test results indicate specified concrete strengths and other characteristics have not been attained in the structure, as directed by Engineer. Testing service may conduct tests to determine adequacy of concrete by cored cylinders complying with ASTM C 42, or by other methods as directed. Contractor shall pay for such tests when unacceptable concrete is verified.

TECHNICAL SPECIFICATIONS FOR GLENDALE FIRE STATION
SECTION 05120 - STRUCTURAL STEEL

PART 1 - GENERAL

1.1 RELATED DOCUMENTS

- A. Drawings and general provisions of Contract, including General and Supplementary Conditions and Division 1 Specification Sections, apply to this Section.

1.2 SUMMARY

- A. This Section includes fabrication and erection of structural steel work, as shown on drawings including schedules, notes, and details showing size and location of members, typical connections, and types of steel required.
 - 1. Structural steel is that work defined in American Institute of Steel Construction (AISC) "Code of Standard Practice" and as otherwise shown on drawings.
 - 2. Miscellaneous Metal Fabrications are specified elsewhere in Division 5.
 - 3. Refer to Division 3 for anchor bolt installation in concrete, Division 4 for anchor bolt installation in masonry.

1.3 SUBMITTALS

- A. General: Submit the following in accordance with Conditions of Contract and Division 1 Specification Conditions Sections.
 - 1. Submit all shop drawings on one reproducible print (sepia) and two copy prints only. The reproducible print will be returned. All copy prints required by the Contractor are the responsibility of the Contractor and shall be made after reproducible is returned.
- B. Product data or manufacturer's specifications and installation-instructions for following products Include laboratory test reports and other data to show compliance with specifications (including specified standards). This data is submitted for information only.
 - 1. Structural steel (each type), including certified copies of mill reports covering chemical and physical properties.
 - 2. High-strength bolts washers (each type), including nuts and washers.

TECHNICAL SPECIFICATIONS FOR GLENDALE FIRE STATION
SECTION 05120 - STRUCTURAL STEEL

- a. Include Direct Tension Indicators if used.
 3. Structural steel primer paint.
 4. Shrinkage-resistant grout.
- C. Shop drawings prepared under supervision of a licensed Structural Engineer, including complete details and schedules for fabrication and assembly of structural steel members, procedures, and diagrams.
1. Include details of cuts, connections, camber, holes, and other pertinent data. Indicate welds by standard AWS symbols and show size, length and type of each weld.
 2. Provide setting drawings, templates, and directions for installation of anchor bolts and other anchorages to be installed as work of other sections.
 3. Contract documents shall not be used for shop drawing, including erection plans or details.
 4. All shop drawings which are resubmitted for any reason shall have all revised items clouded or identified for each submittal.
 5. All structural steel connections not specifically detailed on the drawings shall be designed to resist forces indicated, by the Contractor, under the direct supervision of a Professional Engineer registered in the state in which the project is located.
 6. Design calculations for the connections designed by the Contractor shall be submitted for the files of the Architect and Engineer. Calculations shall bear the seal of a Professional Engineer registered in the state in which the project is located. Shop drawings containing connections for which calculations have not been received will be returned unchecked as an incomplete submittal.
 7. Shop drawings shall be sealed by the Professional Engineer registered in the state in which the project is located that provided the connection design to confirm that the connections shown on the shop drawings are in accordance with the submitted design calculations.

1.5 PERFORMANCE REQUIREMENTS

TECHNICAL SPECIFICATIONS FOR GLENDALE FIRE STATION
SECTION 05120 - STRUCTURAL STEEL

- A. For each connection, the following shall be noted on the shop drawings:
 - 1. Required design reaction
 - 2. Calculation sheet number for design
 - 3. Capacity of detailed connection
- B. Construction: Type PR, Partially Restrained.
- C. Test reports conducted on shop and field-bolted and welded connections. Include data on type (s) of tests conducted and test results.

1.4 QUALITY ASSURANCE

- A. Codes and Standards: Comply with provisions of following, except as otherwise indicated:
 - 1. American Institute of Steel: Construction (AISC) "Code of Standard Practice for Steel Buildings and Bridges", dated March 7, 2000.
 - a. General: AISC "Code of Standard Practice" shall apply except to the extent that references are made to the responsibility of the Owner and/or Architect or Engineer in which event those references shall have no applicability. Where a conflict exists between the Code of Standard Practice and the Contract Documents, the Contract Documents shall govern.
 - b. Paragraph 3.4: In the first sentence, delete the phrase "and made to a scale not less than 1/8" to the foot."
 - 2. AISC "Specifications for Structural Steel Buildings," including "Commentary".
 - 3. AISC "Specifications for Structural Steel Buildings, Section 10, Architecturally Exposed Structural Steel".
 - 4. "Specifications for Structural Joints using ASTM A325 or A490 Bolts" approved by the Research Council on Structural Connections.
 - 5. American Welding Society (AWS) D1.1 "Structural Welding Code - Steel".
 - 6. ASTM A6 "General Requirements for Delivery of Rolled Steel Plates, Shapes, Sheet Piling and Bars for Structural Use."

TECHNICAL SPECIFICATIONS FOR GLENDALE FIRE STATION
SECTION 05120 - STRUCTURAL STEEL

- B. Qualifications for Welding Work: Qualify welding procedures and welding operators in accordance with AWS "Qualification" requirements.
 - 1. Provide certification that welders to be employed in work have satisfactorily passed AWS qualification tests.
 - 2. If recertification of welders is required, retesting will be Contractor's responsibility.

1.05 DELIVERY, STORAGE, AND HANDLING

- A. Deliver materials to site at such intervals to ensure uninterrupted progress of work.
- B. Deliver anchor bolts and anchorage devices, which are to be embedded in cast-in-place concrete or masonry, in ample time to not to delay work.
- C. Store materials to permit: easy access for inspection and identification. Keep steel members off ground by using pallets, platforms, or other supports. Protect steel members and packaged materials from erosion and deterioration. If bolts and nuts become dry or rusty, clean and relubricate before use.
 - 1. Do not store materials on structure in a manner that might cause distortion or damage to members or supporting structures. Repair or replace damaged materials or structures as directed.

PART 2 - PRODUCTS

2.1 MATERIALS

- A. Metal Surfaces, General: For fabrication of work that will be exposed to view, use only materials that are smooth and free of surface blemishes including pitting, rust and scale seam marks, roller marks, rolled trade names, and roughness. Remove such blemishes by grinding, or by welding and grinding, prior to cleaning, treating, and applying surface finishes.
- B. Structural Steel: ASTM A992, Grade 50, For Beams and Columns; ASTM A36 elsewhere.
- C. Cold-Formed Steel Tubing: ASTM A500, Grade B
- D. Hot - Formed Steel Tubing: ASTM A501.

TECHNICAL SPECIFICATIONS FOR GLENDALE FIRE STATION
SECTION 05120 - STRUCTURAL STEEL

- E. Steel Pipe: ASTM A53, Type E or S, Grade B; or ASTM A501.
- F. Connection Material: Unless noted otherwise on the drawings, stiffener plates, doubler plates, gusset plates and the connecting plates shall be the same grade of steel as members being connected.
 - 1. Finish: Black, except where indicated to be galvanized.
- G. Headed Stud-Type Shear Connectors: ASTM A108, Grade 1015 or 1020, cold-finished carbon steel with dimensions complying with AISC Specifications.
- H. Anchor Bolts: ASTM A325, headed type unless otherwise indicated.
- I. Unfinished Threaded Fasteners: ASTM A307, Grade A, regular low-carbon steel bolts and nuts.
 - 1. Provide hexagonal heads and nuts for all connections.
- J. High-Strength, Threaded Fasteners: Heavy hexagon structural bolts, heavy hexagon nuts, and hardened washers, as follows:
 - 1. Quenched and tempered medium-carbon steel bolts, nuts, and washers, complying with ASTM A325.
- K. Electrodes for Welding: Comply with AWS Code.
- L. Nonmetallic Shrinkage-Resistant Grout: Premixed, nonmetallic, noncorrosive, nonstaining product containing selected silica sands, Portland cement, shrinkage compensating agents, plasticizing and water-reducing agents, complying with CE-CRD-C621.

2.2 FABRICATION

- A. Shop Fabrication and, Assembly: Fabricate and assemble structural assemblies in shop to greatest extent possible. Fabricate items of structural steel in accordance with AISC Specifications and as indicated on final shop drawings. Provide camber in structural members where indicated.
 - 1. Properly mark and, match-mark materials for field assembly. Fabricate for delivery sequence that will expedite erection and minimize field handling of materials.
- B. Connections: Weld or bolt shop connections, as indicated.

TECHNICAL SPECIFICATIONS FOR GLENDALE FIRE STATION
SECTION 05120 - STRUCTURAL STEEL

1. Bolt field connections, except where welded connections or other connections are indicated.
 - a. Provide high-strength threaded fasteners for bolted connections.
- C. Simple Beam Connections: Standard double angle framed beam connections using bolts as specified.
 1. Seated Beam Connections and Stiffened Seated Beam Connections shall not be used unless indicated on the drawings or unless Engineer approval is obtained to verify capacity of supporting member for the resulting eccentricity. The fabricator must verify and bear responsibility that the use of such connections does not interfere with Architectural or MEP requirements.
- D. High-Strength Bolted Construction: Install high-strength threaded fasteners in accordance with AISC "Specifications for Structural Joints using ASTM A325 or A490 Bolts."
- E. Welded Construction: Comply with AWS Code for procedures, appearance and quality of welds, and methods used in correcting welding work.
- F. Assemble and weld built-up sections by methods that will produce - true alignment of axes without warp.
- G. Shear Connectors: Prepare steel surfaces as recommended by manufacturer of shear connectors. Weld shear connectors in field, spaced as shown, to beams and girders in composite construction. Use automatic end welding of headed stud shear connectors in accordance with manufacturer's printed instructions.
- H. Steel Wall Framing: Select members that are true and straight for fabrication of steel wall framing. Straighten as required to provide uniform, square, and true members in completed wall framing.
- I. Holes for Other Work: Provide holes required for securing other work to structural steel: framing and for passage of other work through steel framing members, as shown on final shop drawings.
- J. Provide threaded nuts welded to framing and other specialty items as indicated to receive other work.
- K. Cut, drill, or punch holes perpendicular to metal surfaces. Do not flame-cut holes or

TECHNICAL SPECIFICATIONS FOR GLENDALE FIRE STATION
SECTION 05120 - STRUCTURAL STEEL

enlarge holes by burning. Drill holes in bearing plates.

- L. Expansion Joints: Provide expansion joints in steel shelf angles when part of structural steel frame; locate at vertical brick expansion joints as indicated on drawings.

2.3 SHOP PAINTING

- A. General: Shop-paint structural steel, except those portions of members to members or be embedded in concrete or mortar. Paint embedded steel that is partially exposed on exposed portions and initial 2 inches of embedded areas only.
 - 1. Do not paint surfaces to be welded or high-strength bolted with slip-critical-type connections.
 - 2. Do not paint surfaces scheduled to receive sprayed-on fireproofing.
 - 3. Apply 2 coats of paint to surfaces that are inaccessible after assembly or erection. Change color of second coat to distinguish it from first.
- B. Painting: Provide a one-coat, shop-applied paint system complying with Steel Structures Painting Council (SSPC) Paint System Guide No. 7.00.

2.4 SOURCE QUALITY CONTROL

- A. General: Materials and fabrication procedures are subject to inspection and tests in mill, shop, and field, conducted by a qualified inspection agency. Such inspections and tests will not relieve Contractor of responsibility for providing materials and fabrication procedures in compliance with specified requirements.
 - 1. Promptly remove and replace materials or fabricated components that do not comply.
- B. Design of Members and Connections: Details shown are typical; similar details apply to similar conditions, unless otherwise indicated. Verify dimensions at site whenever possible without causing delay in the work.
 - 1. Promptly notify Architect whenever design of members, and connections for any portion of structure are not clearly indicated.

PART 3 - EXECUTION

3.1 ERECTION

TECHNICAL SPECIFICATIONS FOR GLENDALE FIRE STATION
SECTION 05120 - STRUCTURAL STEEL

- A. Temporary Shoring and Bracing: Provide temporary shoring and bracing members with connections of sufficient strength to bear imposed loads. Remove temporary members and connections when permanent members are in place and final connections are made. Provide temporary guy lines to achieve proper alignment of structures as erection proceeds.
- B. Temporary Planking: Provide temporary planking and working platforms as necessary to effectively complete as work.
- C. Setting Bases and Bearing Plates: Clean concrete and masonry bearing surfaces of bond-reducing materials and roughen to improve bond to surfaces. Clean bottom surface of base and bearing plates.
 - 1. Set loose and attached base plates and bearing plates for structural members on wedges or other adjusting devices.
 - 2. Tighten anchor bolts after supported members have been positioned and plumbed. Do not remove wedges or shims, but if protruding, cut off flush with edge of base or bearing plate prior to packing with grout.
 - 3. Pack grout solidly between bearing surfaces and bases or plates to ensure that no voids remain. Finish exposed surfaces, protect installed materials, and allow to cure.
 - 4. For proprietary grout materials, comply with manufacturer's instructions.
- D. Field Assembly: Set structural frames accurately to lines and elevations indicated. Align and adjust various members forming part of complete frame or structure before permanently fastening. Clean bearing surfaces and other surfaces that will be in permanent contact before assembly. Perform necessary adjustments to compensate for discrepancies in elevations and alignment.
- E. Level and plumb individual members of structure within specified AISC tolerances.
- F. Establish required leveling and, plumbing measurements on mean operating temperature of structure. Make allowances for difference between temperature at time of erection and mean temperature at which structure will be when completed and in service.
- G. Splice members only where indicated and accepted on shop drawings.
- H. Erection Bolts: On exposed welded construction, remove erection bolts, fill holes

TECHNICAL SPECIFICATIONS FOR GLENDALE FIRE STATION
SECTION 05120 - STRUCTURAL STEEL

with plug welds, and grind smooth at exposed surfaces. Each erection bolt on shop drawings shall be noted "Erection Bolt".

1. Comply with AISC Specifications for, bearing, adequacy of temporary connections, alignment, and removal of paint on surfaces adjacent to field welds.
 2. Do not enlarge unfair holes in members by burning or by using drift pins, except in secondary bracing members. Ream holes that must be enlarged to admit bolts.
- I. Gas Cutting: Do not use gas cutting torches in field for correcting fabrication errors in primary structural framing. Cutting will be permitted only on secondary members that are not under stress, as acceptable to Architect. Finish gas-cut sections equal to a sheared appearance when permitted.
- J. Touch-Up Painting: Immediately after erection, clean field welds, bolted connections, and abraded areas of shop paint. Apply paint to exposed areas using same material as used for shop painting.
1. Apply by brush or spray to provide minimum dry film thickness of 1.5 mils.

3.2 QUALITY CONTROL

- A. The Owner will engage an independent testing and inspection agency to inspect high-strength bolted connections and welded connections and to perform tests and prepare test reports.
- B. Testing agency shall conduct and interpret tests, state in each report whether test specimens comply with requirements, and specifically state any deviations therefrom.
- C. Provide access for testing agency to places where structural steel work is being fabricated or produced so that required inspection and testing can be accomplished.
- D. Testing agency may inspect structural steel at plant before shipment.
- E. Correct deficiencies in structural steel work that inspections and laboratory test reports have indicated to be not in compliance with requirements. Perform additional tests, at Contractor's expense, as necessary to reconfirm any noncompliance of original work and to show compliance of corrected work.

TECHNICAL SPECIFICATIONS FOR GLENDALE FIRE STATION
SECTION 05120 - STRUCTURAL STEEL

F. Field Inspections and Tests:

1. Check steel as received in the field for possible making and shipping damage workmanship, piece making and verification of required camber.

G. Shop-Bolted Connections:

1. Inspect or test in accordance with AISC specifications.
2. For non-slip critical bolted connections (bearing-type), all connections shall be visually observed to assure that all bolts, nuts and washers are in place and that all plies of connection material have been drawn together. All bolts shall be verified to be snug tight only.

H. Shop Welding: Inspect and test during fabrication of structural steel assemblies, as follows:

1. Certify welders and conduct inspections and tests as required. Record types and locations of defects found in work. Record work required and performed to correct deficiencies.
2. Perform visual inspection of all welds, including but not limited to fit-up, intermediate passes and final weld.
3. Perform tests of welds as follows: Inspection procedures listed.
 - a. Magnetic Particle Inspection: ASTM E 709; performed on root pass and on finished weld. Inspect full length of 10% of fillet welds for each type of welded connection. Cracks or zones of incomplete fusion or penetration not acceptable. Rejection of any portion of a weld inspected on less than 100% basis shall require inspection of 100% of that weld.
 - b. Ultrasonic Inspection: ASTM E164. Perform on all full and partial penetration welds.

I. Field-Bolted Connections:

1. Inspect in accordance with AISC specifications.
2. For non-slip critical bolted connections (bearing-type), all connections shall be visually observed to assure that all bolts, nuts and washers are in place and that all plies of connection material have been drawn together. All bolts shall be verified to be snug tight only.

TECHNICAL SPECIFICATIONS FOR GLENDALE FIRE STATION
SECTION 05120 - STRUCTURAL STEEL

3. Bolts in slotted holes at expansion joints shall have nuts finger tight with threads not damaged.
- J. Field Welding: Inspect and Test during erection of structural steel as follows:
1. Certify welders and conduct inspections and tests as required. Record types and locations of defects found in work. Record work required and performed to correct deficiencies.
 2. Perform visual inspection of all welds, including but not limited to fit-up, intermediate passes and final weld.
 3. Perform tests of welds as follows:
 - a. Magnetic Particle Inspection: ASTM E709; performed on root pass and on finished weld. Inspect full length of 10% of fillet welds for each type of welded connection. Cracks or zones of incomplete fusion or penetration not acceptable. Rejection of any portion of a weld inspected on less than 100% basis shall require inspection of 100% of that weld.
 - b. Ultrasonic Inspection: ASTM E164. Perform on all full and partial penetration welds.

END OF SECTION 05120

TECHNICAL SPECIFICATIONS FOR GLENDALE FIRE STATION
SECTION 05400 - COLD-FORMED METAL FRAMING
PART 1 - GENERAL

1.1 RELATED DOCUMENTS

- A. Drawings and general provisions of the Contract, including General and Supplementary Conditions and Division 1 Specification Sections, apply to this Section

1.2 SUMMARY

- A. This Section includes the following:
 - 1. Exterior load-bearing wall framing.
 - 2. Interior load-bearing wall framing.
 - 3. Ceiling joist framing at vault.
- B. Related Sections include the following:
 - 1. Division 5 Section "Metal Fabrications" for masonry shelf angles and connections.
 - 2. Division 6 Section "Rough Carpentry" for subflooring, wall sheathing; or roof sheathing using, wood-based structural-use panels, particleboard, fibrous-felted board, and foam-plastic sheathing.
 - 3. Division 9 Section "Gypsum Board Assemblies" for interior non-load-bearing metal-stud framing and ceiling-suspension assemblies.

1.3 DEFINITIONS

- A. Minimum Uncoated Steel Thickness: Minimum uncoated thickness of cold-formed framing delivered to the Project site shall be not less than 95 percent of the thickness used in the cold-formed framing design. Lesser thicknesses shall be permitted at bends due to cold forming.
- B. Producer: Entity that produces steel sheet coil fabricated into cold-formed members.

1.4 SUBMITTALS

- A. General: Submit the following in accordance with Conditions of Contract and Division 1 Specification Sections.
 - 1. Submit all shop drawings on one reproducible print (sepia) and two prints only. The reproducible print will be returned. All blue line prints required by the Contractor are the responsibility of the Contractor and shall be made after the reproducible is returned.
- B. Product Data: For each type of cold-formed metal framing product and accessory

TECHNICAL SPECIFICATIONS FOR GLENDALE FIRE STATION

SECTION 05400 - COLD-FORMED METAL FRAMING

indicated.

- C. Shop Drawings: Show layout, spacings, sizes, thicknesses, and types of cold-formed metal framing; fabrication; and fastening and anchorage details, including mechanical fasteners. Show reinforcing channels, opening framing, supplemental framing, strapping, bracing, bridging, splices, accessories, connection details, and attachment to adjoining Work.
- D. Welding Certificates: Copies of certificates for welding procedures and personnel.
- E. Qualification Data: For firms and persons specified in "Quality Assurance" Article to demonstrate their capabilities and experience. Include lists of completed projects with project names and addresses, names and addresses of architects and owners, and other information specified.

1.5 QUALITY ASSURANCE

- A. Installer Qualifications: An experienced installer who has completed cold-formed metal framing similar in material, design, and extent to that indicated for this Project and whose work has resulted in construction with a record of successful in-service performance.
- B. Welding: Qualify procedures and personnel according to AWS D1.1, "Structural Welding Code-Steel, and AWS D1.3, "Structural Welding Code-Sheet Steel".
- C. AISI Specifications: Comply with AISI's "Specification for the Design of Cold-Formed Steel Structural Members" or "Load and Resistance Factor Design Specification for Cold-Formed Steel Structural Members" and the following for calculating structural characteristics of cold-formed metal framing:
 - 1. CCFSS Technical Bulletin: "AISI Specification Provisions for Screw Connections."
- D. Preinstallation Conference: Conduct conference at Project site to comply with requirements in Division 1 Section "Project Meetings."

1.6 DELIVERY, STORAGE, AND HANDLING

- A. Protect cold-formed metal framing from corrosion, deformation, and other damage during delivery, storage, and handling.
- B. Store cold-formed metal framing, protect with a waterproof covering, and ventilate to avoid condensation.

PART 2 - PRODUCTS

2.1 MANUFACTURERS

TECHNICAL SPECIFICATIONS FOR GLENDALE FIRE STATION
SECTION 05400 - COLD-FORMED METAL FRAMING

- A. Manufacturers: Subject to compliance with requirements, provide cold-formed metal framing by one of the following:
1. Allied American Studco, Inc.
 2. Angeles Metal Systems.
 3. California Expanded Metal Products Co.
 4. California Metal Systems, Inc.
 5. Clark Steel Framing Industries.
 6. Consolidated Fabricators Corp.
 7. Consolidated Systems, Inc.
 8. Dale Industries, Inc.
 9. Design Shapes in Steel.
 10. Dietrich Industries, Inc.
 11. Knorr Steel Framing Systems.
 12. MarinoWare; Div. of Ware Industries, Inc.
 13. Scafco Corp.
 14. Steel Construction Systems.
 15. Steel Developers, LLC.
 16. Steeler, Inc.
 17. Studco of Hawaii, Inc.
 18. Super Stud Building Products, Inc.
 19. United Metal Products, Inc.
 20. Western Metal Lath.

2.2 MATERIALS

- A. Steel Sheet: ASTM A 653/A 653M, structural steel, zinc coated, of grade and coating as follows:
1. Grade: 33 for minimum uncoated steel thickness of 0.0428 inch and less; 50, Class 1 for minimum uncoated steel thickness of 0.0538 inch and greater.

2.3 LOAD-BEARING WALL FRAMING

- A. Steel Studs: Manufacturer's standard C-shaped steel studs, of web depths indicated, punched, with stiffened flanges, complying with ASTM C 955, and as follows:
1. Minimum Uncoated-Steel Thickness: 0.0329 inch.
 2. Flange Width: 1-5/8 inches.
- B. Steel Track: Manufacturer's standard C-shaped steel track, of web depths indicated, unpunched, with straight flanges, complying with ASTM C 955, and as follows:
1. Minimum Uncoated-Steel Thickness: 0.0329 inch matching steel studs.

TECHNICAL SPECIFICATIONS FOR GLENDALE FIRE STATION

SECTION 05400 - COLD-FORMED METAL FRAMING

2. Flange Width: 1-1/4 inches.

2.4 CEILING JOIST FRAMING

- A. Steel Ceiling Joists: Manufacturer's standard C-shaped steel sections, of web depths indicated, unpunched, with stiffened flanges, complying with ASTM C 955, and as follows:
 1. Minimum Uncoated-Steel Thickness: 0.0329 inch.
 2. Flange Width: 1-5/8 inches, minimum.

2.5 FRAMING ACCESSORIES

- A. Fabricate steel-framing accessories of the same material and finish used for framing members, with a minimum yield strength of 33,000 psi.
- B. Provide accessories of manufacturer's standard thickness and configuration, unless otherwise indicated, as follows:
 1. Supplementary framing.
 2. Bracing, bridging, and solid blocking.
 3. Web stiffeners.
 4. End clips.
 5. Gusset plates.
 6. Stud kickers, knee braces, and girts.
 7. End closures.
 8. Hole reinforcing plates.
 9. Backer plates.

2.6 ANCHORS, CLIPS, AND FASTENERS

- A. Steel Shapes and Clips: ASTM A 36/A 36M, zinc coated by hot-dip process according to ASTM A 123.
- B. Anchor Bolts: ASTM F 1554, Grade 36, threaded carbon-steel hex-headed, bolts and carbon-steel nuts; and flat, hardened-steel washers; zinc coated by hot-dip process according to ASTM A 153/A 153M, Class C.
- C. Expansion Anchors: Fabricated from corrosion-resistant materials, with capability to sustain, without failure, a load equal to 3.75 times design load, as determined by testing per ASTM E 488 conducted by a qualified independent testing agency.
- D. Power-Actuated Anchors: Fastener system of type suitable for application indicated, fabricated from corrosion-resistant materials, with capability to sustain, without failure, a load equal to 8 times design load, as determined by testing per ASTM E 1190 conducted by a qualified independent testing agency.

TECHNICAL SPECIFICATIONS FOR GLENDALE FIRE STATION

SECTION 05400 - COLD-FORMED METAL FRAMING

E. Mechanical Fasteners: Corrosion-resistant-coated, self-drilling, self-threading steel drill screws.

1. Head Type: Low-profile head beneath sheathing, manufacturer's standard elsewhere.

F. Welding Electrodes: Comply with AWS standards.

2.7 MISCELLANEOUS MATERIALS

A. Galvanizing Repair Paint: ASTM A 780.

B. Cement Grout: Portland cement, ASTM C 150, Type I; and clean, natural sand, ASTM C 404: Mix at ratio of 1 part cement to 2-1/2 parts sand, by volume, with minimum water required for placement and hydration.

2.8 FABRICATION

A. Fabricate cold-formed metal framing and accessories plumb, square, and true to line, and with connections securely fastened, according to manufacturer's written recommendations and requirements in this Section.

1. Fabricate framing assemblies using jigs or templates.

2. Cut framing members by sawing or shearing; do not torch cut.

3. Fasten cold-formed metal framing members by welding or screw fastening, as standard with fabricator. Wire tying of framing members is not permitted.

a. Comply with AWS D1.3 requirements and procedures for welding, appearance and quality of welds, and methods used in correcting welding work.

b. Locate mechanical fasteners and install according to Shop Drawings, with screw penetrating joined members by not less than three exposed screw threads.

B. Reinforce, stiffen, and brace framing assemblies to withstand handling, delivery, and erection stresses. Lift fabricated assemblies to prevent damage or permanent distortion.

C. Fabrication Tolerances: Fabricate assemblies level, plumb, and true to line to a maximum allowable tolerance variation of 1/8 inch in 10 feet and as follows:

1. Spacing: Space individual framing members no more than plus or minus 1/8 inch from plan location. Cumulative error shall not exceed minimum fastening requirements of sheathing or other finishing materials.

2. Squareness: Fabricate each cold-formed metal framing assembly to a

TECHNICAL SPECIFICATIONS FOR GLENDALE FIRE STATION

SECTION 05400 - COLD-FORMED METAL FRAMING

maximum out-of-square tolerance to 1/8 inch.

PART 3 - EXECUTION

3.1 EXAMINATION

- A. Examine supporting substrates and abutting structural framing for compliance with requirements for installation tolerances and other conditions affecting performance. Proceed with installation only after unsatisfactory conditions have been corrected.

3.2 PREPARATION.

- A. Grout bearing surfaces uniform and level to ensure full contact of bearing flanges or track webs on supporting concrete or masonry construction.

3.3 INSTALLATION, GENERAL

- A. Cold-formed metal framing may be shop or field fabricated for installation, or it may be field assembled.
- B. Install cold-formed metal framing according to ASTM C 1007, unless more stringent requirements are indicated.
- C. Install cold-formed metal framing and accessories plumb, square, and true to line, and with connections securely fastened, according to manufacturer's written recommendations and requirements in this Section.
 - 1. Cut framing members by sawing or shearing; do not torch cut.
 - 2. Fasten cold-formed metal framing members by welding or screw fastening, as standard with fabricator. Wire tying of framing members is not permitted.
 - a. Comply, with AWS 01.3 requirements and procedures for welding, appearance and quality of welds, and methods used in correcting welding work.
 - b. Locate mechanical fasteners and install according to Shop Drawings, with screw penetrating joined members by not less than three exposed screw threads.
- D. Install framing members in one-piece lengths, unless splice connections are indicated for track or tension members.
- E. Install temporary bracing and supports to secure framing and support loads comparable in intensity to those for which structure was designed. Maintain braces and supports in place, undisturbed, until entire integrated supporting structure has been completed and permanent connections to framing are secured.

TECHNICAL SPECIFICATIONS FOR GLENDALE FIRE STATION

SECTION 05400 - COLD-FORMED METAL FRAMING

- F. Fasten hole reinforcing plate over web penetrations that exceed size of manufacturer's standard punched openings.
- G. Erection Tolerances: Install cold-formed metal framing level, plumb, and true to line to a maximum allowable tolerance variation of 1/8 inch in 10 feet and as follows:
 - 1. Space individual framing members no more than plus or minus 1/8 inch from plan Location. Cumulative error shall not exceed minimum fastening requirements of sheathing or other finishing materials.

3.4 LOAD-BEARING WALL INSTALLATION

- A. Install continuous top and bottom tracks sized to match studs. Align tracks accurately and securely anchor at corners and ends, and at spacings as shown on drawings.
- B. Squarely seat studs against, webs, of top and bottom tracks. Fasten both flanges of studs to top and bottom tacks. Space studs as shown on drawings.
- C. Set studs plumb, except as needed for diagonal bracing or required for nonplumb walls or warped surfaces and similar configurations.
- D. Anchor studs abutting structural columns or walls, including masonry walls, to supporting structure as indicated.
- E. Install headers over wall openings wider than stud spacing. Locate headers above openings as indicated. Fabricate headers of compound shapes indicated or required to transfer load to supporting studs, complete with clip-angle connectors, web stiffeners, or gusset plates.
 - 1. Frame wall openings with not less than a double stud at each jamb of frame as indicated on Shop Drawings.
 - 2. Install runner tracks and jack studs above and below wall openings. Anchor tracks to jamb studs with clip angles or by welding, and space jack studs same as full-height wall studs.
- F. Install supplementary framing, blocking, and bracing in stud framing indicated to support fixtures, equipment, services, casework, heavy trim, furnishings, and similar work requiring attachment to framing.
 - 1. If type of supplementary support is not indicated, comply with stud manufacturer's written recommendations and industry standards in each case considering weight or load resulting from item supported.
- G. Install horizontal bridging in stud system spaced as indicated on the drawings. Fasten at each stud intersection:

TECHNICAL SPECIFICATIONS FOR GLENDALE FIRE STATION
SECTION 05400 - COLD-FORMED METAL FRAMING

1. Bridging: Cold-rolled steel channel, welded or mechanically fastened to webs of punched studs with a minimum of two screws into each flange of the clip angle.
- H. Install miscellaneous framing and connections, including supplementary framing, web stiffeners, clip angles, continuous angles, anchors, and fasteners to provide a complete and stable wall-framing system.

3.5 JOIST INSTALLATION

- A. Install perimeter joist track sized to match joists. Align and securely anchor or fasten track to supporting structure at corners, ends, and spacings indicated on Shop Drawings.
- B. Install joists bearing on supporting frame, level, straight, and plumb; adjust to final position, brace and reinforce. Fasten joists to both flanges of joist track.
1. Install joists over supporting frame with a minimum end bearing of 1-1/2 inches.
 2. Reinforce ends and bearing points of joists with web stiffeners, end clips, joist hangers, steel clip angles, or steel-stud sections as indicated on Shop Drawings.
- C. Space joists not more than 2 inches from abutting walls and as follows:
1. Joist Spacing: As indicated on drawings.
- D. Install web stiffeners at supports.
- E. Install bridging at each end of joists and at intervals indicated on the drawings. Fasten bridging at each joist intersection as follows:
1. Bridging: Cold-rolled steel channel welded or mechanically fastened to bottom flange of joists.
 2. Bridging: Joist-track solid blocking of width and thickness indicated, secured to joist webs.
- F. Secure joists to load-bearing interior walls to prevent lateral movement of bottom flange.
- G. Install miscellaneous joist framing and connections, including web stiffeners, closure pieces, clip angles, continuous angles, hold-down angles, anchors and fasteners to provide a complete and stable joist-framing assembly.

3.6 REPAIRS AND PROTECTION

TECHNICAL SPECIFICATIONS FOR GLENDALE FIRE STATION
SECTION 05400 - COLD-FORMED METAL FRAMING

- A. Galvanizing Repairs: Prepare and repair damaged galvanized coatings on fabricated and installed cold-formed metal framing with galvanized repair paint according to ASTM A 780 and manufacturer's written instructions.

END OF SECTION 05400

TECHNICAL SPECIFICATIONS FOR GLENDALE FIRE STATION
SECTION 05500 - METAL FABRICATIONS

PART 1 - GENERAL

1.0 RELATED DOCUMENTS

- A. Drawings and general provisions of the Contract, including General and Supplementary Conditions and Division 1 Specification Sections, apply to this Section.

1.1 SUMMARY

- A. This Section includes the following metal fabrications:

1. Rough hardware.
2. Loose bearing and leveling plates.
3. Loose steel lintels.
4. Metal Access Panels

- B. Miscellaneous framing and supports for the following:

- 1, Applications where framing and supports are not specified in other sections.

1. Related Sections: The following Sections contain requirements that relate to this Section:

- C. Division 5 Section "Structural Steel" for structural steel framing system components.

1.2 SUBMITTALS

- A. General: Submit each item in this Article according to the Conditions of the Contract and Division 1 Specification Sections.

1. Product data for nonslip aggregates and nonslip aggregate surface finishes, prefabricated building columns, cast nosings, treads and thresholds, steel floor plate, paint products, and grout.
2. Shop drawings detailing fabrication and erection of each metal fabrication indicated. Include plans, elevations, sections, and details of metal fabrications and their connections. Show anchorage and accessory items. Provide templates for anchors and bolts specified for installation under other Sections.
3. Samples representative of materials and finished products as may be requested by Architect.
4. Welder certificates signed by Contractor certifying that welders comply with requirements specified under the "Quality Assurance" Article.

TECHNICAL SPECIFICATIONS FOR GLENDALE FIRE STATION
SECTION 05500 - METAL FABRICATIONS

1.3 QUALITY ASSURANCE

- A. Fabricator Qualifications: Firm experienced in producing metal fabrications similar to those indicated for this Project with a record of successful in-service performance, and with sufficient production capacity to produce required units without delaying the Work.
- B. Welding Standards: Comply with applicable provisions of AWS 01.1 "Structural Welding Code-Steel," AWS 01.2 "Structural Welding Code-Aluminum," and AWS 01.3 "Structural Welding Code-Sheet Steel."
 - 1. Certify that each welder has satisfactorily passed AWS qualification tests for welding processes involved and if pertinent, has undergone recertification.

1.4 PROJECT CONDITIONS

- A. Field Measurements: Check actual locations of walls and other construction to which metal fabrications must fit by accurate field measurements before fabrication. Show recorded measurements on final shop drawings. Coordinate fabrication schedule with construction progress to avoid delaying the Work.

PART 2 - PRODUCTS

2.0 FERROUS METALS

- A. Metal Surfaces: General: For metal fabrications exposed to view hi the completed Work, provide materials selected for their surface flatness, smoothness, and freedom from surface blemishes. Do not use materials with exposed pitting, seam marks, roller marks, rolled trade names, or roughness.
 - 1. Steel Plates. Shapes and Bars: ASTM A 36 (ASTM A 36M).
- B. Cast-in-Place Anchors in Concrete: Anchors of type indicated below, fabricated from corrosion resistant materials capable of sustaining, without failure, the load imposed within a safety factor of 4, as determined by testing per ASTM E 488, conducted by a qualified independent testing agency.
 - 1. Threaded or wedge type; galvanized ferrous castings, either ASTM A 47 (ASTM A 47M) malleable iron or ASTM A 27/A 27M cast steel. Provide bolts, washers, and shims as required, hot-dip galvanized per ASTM A 153.

2.1 ALUMINUM

TECHNICAL SPECIFICATIONS FOR GLENDALE FIRE STATION
SECTION 05500 - METAL FABRICATIONS

- A. Aluminum Extrusions: ASTM B 221 (ASTM B 221M), alloy 6063-T6.
- B. Aluminum-Alloy Rolled Tread Plate: ASTM B 632 (ASTM B 632M) Pattern 1, alloy 6061-T6.

2.2 PAINT

- A. Shop Primer for Ferrous Metal: Fast-curing, lead and chromate-free, universal modified-alkyd primer complying with performance requirements of FS TT-P-664, selected for good resistance to normal atmospheric corrosion, compatibility with finish paint systems indicated, and capability to provide a sound foundation for field-applied topcoats despite prolonged exposure.
- B. Galvanizing Repair Paint, High-zinc-dust-content paint for regalvanizing welds in galvanized steel, with dry film containing not less than 94 percent zinc dust by weight, and complying with DOD-P-21035 or SSPC-Paint 20.
- C. Bituminous Paint: Cold-applied asphalt mastic complying with SSPC-Paint 12, except containing no asbestos fibers.

2.3 FASTENERS

- A. General: Provide plated fasteners complying with ASTM 8 633, Class Fe/Zn 25 for electrode posited zinc coating, for exterior use or where built into exterior walls. Select fasteners for the type, grade, and class required.
- B. Bolts and Nuts: Regular hexagon-head bolts, ASTM A 307, Grade A (ASTM F 568, Property Class 4.6), with hex nuts, ASTM A 563 (ASTM A 563M), and, where indicated, flat washers.
 - 1. Machine Screws: ANSI 818.6.3.
 - 2. Lao Bolts: ANSI B18.2.1 (ANSI 818.2.3.8M).
 - 3. Wood Screws: Flat head, carbon steel, ANSI 818.6.1.
 - 4. Plain Washers: Round, carbon steel, ANSI 818.22.1 (ANSI B18.22M).
 - 5. Lock Washers: Helical, spring type, carbon steel, ANSI B18.21.1.

2.4 GROUT

- A. Nonshrink, Nonmetallic Grout: Factory-packaged, nonstaining, noncorrosive, nongaseous grout complying with ASTM C 1107. Provide grout specifically

TECHNICAL SPECIFICATIONS FOR GLENDALE FIRE STATION
SECTION 05500 - METAL FABRICATIONS

recommended by manufacturer for interior and exterior applications.

- B. Subject to compliance with requirements, provide one of the following:
1. Nonshrink Nonmetallic Grouts:
 - a. B-6 Construction Grout; W. R. Bonsai Co.
 - b. Euco N-S Grout; Euclid Chemical Co.
 - c. Crystex; L & M Construction Chemicals, Inc.
 - d. Masterflow 928 and 713; Master Builders Technologies, Inc.
 - e. Sealtight 588 Grout; W. R. Meadows, Inc.
 - f. SonogROUT 14; Sonneborn Building Products-ChemRex, Inc.

2.5 FABRICATION - GENERAL

- A. Form metal fabrications from materials of size; thickness, and shapes indicated but not less than that needed to comply with performance requirements indicated. Work to dimensions indicated or accepted on shop, drawings, using proven details of fabrication and support. Use type of materials indicated or specified for various components of each metal fabrication.
- B. Form exposed work true to line and level with accurate angles and surfaces and straight sharp edges.
- C. Allow for thermal movement resulting from the following maximum change (range) in ambient temperature in the design, fabrication, and installation of installed metal assemblies to prevent buckling, opening up of joints, and overstressing of welds and fasteners. Base design calculations on actual surface temperatures of metals due to both solar heat gain and nighttime sky heat loss.
1. Temperature Change (Range): 120 deg F (67 deg C).
- D. Shear and punch metals cleanly and accurately. Remove burrs.
- E. Ease exposed edges to a radius of approximately 1/32 inch (1 mm), unless otherwise indicated. Form bent-metal comers to smallest radius possible without causing grain separation or otherwise impairing work.
- F. Remove sharp or rough areas on exposed traffic surfaces.
- G. Weld comers and seams continuously to comply with the following:
1. Use materials and methods that minimize distortion and develop strength

TECHNICAL SPECIFICATIONS FOR GLENDALE FIRE STATION
SECTION 05500 - METAL FABRICATIONS

and corrosion resistance of base metals.

2. Obtain fusion without undercut or overlap.
 3. Remove welding flux immediately.
 4. At exposed connections, finish exposed welds and surfaces smooth and blended so that no roughness shows after finishing, and contour of welded surface matches those adjacent.
- H. Form exposed connections with hairline joints, flush and smooth, using concealed fasteners wherever possible. Use exposed fasteners of type indicated or, if not indicated, Phillips flathead (countersunk) screws or bolts. Locate joints where least conspicuous.
- I. Provide for anchorage of type indicated; coordinate with supporting structure. Fabricate and space anchoring devices to secure metal fabrications rigidly 'in place and to support indicated loads.
- J. Shop Assembly: Preassemble items in shop to greatest extent possible to minimize field splicing and assembly. Disassemble units only as necessary for shipping and handling limitations. Use connections that maintain structural value of joined pieces. Clearly mark units for reassembly and coordinated installation.
1. Cut reinforce, drill, and tap metal fabrications as indicated to receive finish hardware, screws, and similar items.
 2. Fabricate joints that will be exposed to weather in a manner to exclude water, or provide weep holes where water may accumulate.

2.6 ROUGH HARDWARE

- A. Furnish bent, or otherwise custom-fabricated, bolts, plates, anchors, hangers, dowels, and other miscellaneous steel and iron shapes as required for framing and supporting woodwork, and for anchoring or securing woodwork to concrete or other structures. Straight bolts and other stock rough hardware items are specified in Division 6 Sections:
- B. Fabricate items to sizes, shapes, and dimensions required. Furnish malleable-iron washers for heads and nuts that bear on wood structural connections, and furnish steel washers elsewhere.

2.7 LOOSE STEEL LINTELS

TECHNICAL SPECIFICATIONS FOR GLENDALE FIRE STATION
SECTION 05500 - METAL FABRICATIONS

A. Fabricate loose structural steel lintels from steel angles and shapes of size indicated for openings and recesses in masonry walls and partitions at locations indicated.

1. Weld adjoining members together to form a single unit where indicated.
2. Size loose lintels for equal bearing of 1 inch per foot (85 mm per meter) of clear span but not less than 8 inches (200 mm) bearing at each side of openings, unless otherwise indicated.
3. Galvanize loose steel lintels located in exterior walls.

2.8 METAL ACCESS PANELS

A. Fabricate metal access panels from galvanized metal to be painted after assembly and installation. Refer to drawings for location and quantity.

1. Size: 2'-0" X 2'-0"

2.9 FINISHES - GENERAL

A. Comply with NAAMM "Metal Finishes Manual" for recommendations relative to applying and designing finishes.

1. Finish metal fabrications after assembly.

2.9.1 STEEL AND IRON FINISHES

A. Galvanizing: For those items indicated for galvanizing, apply zinc coating by the hot-dip process complying with the following requirements:

1. ASTM 153 for galvanizing iron and steel hardware.
2. ASTM A 123 for galvanizing both fabricated and unfabricated iron and steel products made of uncoated rolled, pressed, and forged shapes; plates, bars, and strip 0.0299 inch (0.76 mm) thick or thicker.

B. Preparation for Shop Priming: Prepare uncoated ferrous metal surfaces to comply with minimum requirements indicated below for SSPC surface preparation, specifications and, environmental exposure conditions of installed metal fabrications:

1. Exteriors (SSPC Zone 18): SSPC-SP 6 "Commercial Blast Cleaning."

TECHNICAL SPECIFICATIONS FOR GLENDALE FIRE STATION
SECTION 05500 - METAL FABRICATIONS

2. Interiors (SSPC Zone 1A): SSPC-SP 3 "Power Tool Cleaning."

C. Apply shop primer to uncoated surfaces of metal fabrications, except those with galvanized finishes or to be embedded in concrete, sprayed-on fireproofing, or masonry, unless otherwise indicated. Comply with requirements of SSPC-PA 1 "Paint Application Specification No.1" for shop painting.

1. Stripe paint corners, crevices, bolts, welds, and sharp edges.

2.9.2 ALUMINUM FINISHES

A. Finish designations prefixed by AA conform to the system established by the Aluminum Association for designating aluminum finishes.

B. As-Fabricated Finish: AA-M10 (Mechanical Finish: as fabricated, unspecified).

PART 3 - EXECUTION

3.0 PREPARATION

A. Coordinate and furnish anchorages, setting drawings, diagrams, templates, instructions, and directions for installing anchorages, including concrete inserts, sleeves, anchor bolts, and miscellaneous items having integral anchors that are to be embedded in concrete or masonry construction. Coordinate delivery of such items to Project site.

3.1 INSTALLATION - GENERAL

A. Fastening to In-Place Construction: Provide anchorage devices and fasteners where necessary for securing miscellaneous metal fabrications to in-place construction. Include threaded fasteners for concrete and masonry inserts, toggle bolts, through-bolts, lag bolts, wood screws, and other connectors as required.

1. Cutting, Fitting, and Placement: Perform cutting, drilling, and fitting required for installing miscellaneous metal fabrications. Set metal fabrication accurately in location, alignment, and elevation; with edges and surfaces level, plumb, true, and free of rack; and measured from established lines and levels.

2. Provide temporary bracing or anchors in formwork for items that are to be built into concrete masonry or similar construction.

3. Fit exposed connections accurately together to form hairline joints. Weld connections that are not to be left as exposed joints but cannot be shop-welded

TECHNICAL SPECIFICATIONS FOR GLENDALE FIRE STATION
SECTION 05500 - METAL FABRICATIONS

because of shipping size limitations. Do not weld, cut, or abrade the surfaces of exterior units that have been hot-dip galvanized after fabrication and are intended for bolted or screwed field connections.

4. Field Welding: Comply with the following requirements:

- a. Use materials and methods that minimize distortion and develop strength and corrosion resistance of base metals.
 - b. Obtain fusion without undercut or overlap.
 - c. Remove welding flux immediately.
- B. At exposed connections, finish exposed welds and surfaces smooth and blended so that no roughness shows after finishing, and contour of welded surface matches those adjacent.
- C. Corrosion Protection: Coat concealed surfaces of aluminum that will come into contact with, grout, concrete, masonry, wood, or dissimilar metals with a heavy coat of bituminous paint.

3.2 SETTING LOOSE PLATES

- A. Clean concrete and masonry bearing surfaces of bond-reducing materials, and roughen to improve bond to surfaces. Clean bottom surface of bearing plates.
- B. Set loose leveling and bearing plates on wedges or other adjustable devices. After the bearing members have been positioned and plumbed, tighten the anchor bolts. Do not remove wedges or shims, but if protruding, cut off flush with the edge of the bearing plate before packing with grout.
1. Use nonshrink, metallic grout in concealed locations where not exposed to moisture; use nonshrink, nonmetallic grout in exposed locations, unless otherwise indicated.
 2. Pack around solidly between bearing surfaces and plates to ensure that no voids remain.

3.3 ADJUSTING AND CLEANING

- A. Touchup Painting: Immediately after erection, clean field welds, bolted connections, and abraded areas of shop paint, and paint exposed areas with same material as used for shop painting to comply with SSPC-PA 1 requirements for touching up shop-painted surfaces.

TECHNICAL SPECIFICATIONS FOR GLENDALE FIRE STATION
SECTION 05500 - METAL FABRICATIONS

1. Apply by brush or spray to provide a 2.0-mil (0.05-mm) minimum dry film thickness.
- B. Touchup Painting: Cleaning and touchup painting of field welds, bolted connections, and abraded areas of the shop paint on miscellaneous metal is specified in Division 9 Section "Painting."
- C. For galvanized surfaces, clean welds, bolted connections, and abraded areas, and apply galvanizing repair paint to comply with ASTM A 780.

END OF SECTION 05500

TECHNICAL SPECIFICATIONS FOR GLENDALE FIRE STATION
SECTION 06100 – ROUGH CARPENTRY

PART 1 - GENERAL

1.1 RELATED DOCUMENTS

- A. Drawings and general provisions of the Contract, including General and Supplementary Conditions and Division 1 Specification Sections, apply to this Section.

1.2 SUMMARY

- A. This Section includes the following:
 - 1. Framing with dimension lumber.
 - 2. Wood blocking and nailers.
 - 3. Wood furring.

1.3 DEFINITIONS

- A. Exposed Framing: Framing not concealed by other construction.
- B. Dimension Lumber: Lumber of 2 inches nominal or greater but less than 5 inches nominal in least dimension.
- C. Timber: Lumber of 5 inches nominal or greater in least dimension.
- D. Lumber grading agencies, and the abbreviations used to reference them, include the following:
 - 1. NeLMA: Northeastern Lumber Manufacturers' Association.
 - 2. NLGA: National Lumber Grades Authority.
 - 3. RIS: Redwood Inspection Service.
 - 4. SPIB: The Southern Pine Inspection Bureau.
 - 5. WCLIB: West Coast Lumber Inspection Bureau.
 - 6. WWPA: Western Wood Products Association

1.4 QUALITY ASSURANCE

- A. Source Limitations for Engineered Wood Products: Obtain each type of engineered wood product through one source from a single manufacturer.
- B. Forest Certification: For the following wood products, provide materials produced from wood obtained from forests certified by an FSC-accredited certification body to comply with FSC 1.2, "Principles and Criteria":
 - 1. Dimension lumber framing.
 - 2. Timber.

TECHNICAL SPECIFICATIONS FOR GLENDALE FIRE STATION
SECTION 06100 – ROUGH CARPENTRY

3. Laminated veneer lumber.
4. Parallel-strand lumber.
5. Prefabricated wood I-joists.
6. Rim boards.
7. Miscellaneous lumber.

1.5 DELIVERY, STORAGE, AND HANDLING

- A. Stack lumber flat with spacers between each bundle to provide air circulation. Provide for air circulation around stacks and under coverings.

PART 2 - PRODUCTS

2.1 WOOD PRODUCTS, GENERAL

- A. Lumber: DOC PS 20 and applicable rules of grading agencies indicated. If no grading agency is indicated, provide lumber that complies with the applicable rules of any rules-writing agency certified by the ALSC Board of Review. Provide lumber graded by an agency certified by the ALSC Board of Review to inspect and grade lumber under the rules indicated.
 1. Factory mark each piece of lumber with grade stamp of grading agency.
 2. For exposed lumber indicated to receive a stained or natural finish, and mark grade stamp on end or back of each piece.
 3. Where nominal sizes are indicated, provide actual sizes required by DOC PS 20 for moisture content specified. Where actual sizes are indicated, they are minimum dressed sizes for dry lumber.
 4. Provide dressed lumber, S4S, unless otherwise indicated.
- B. Engineered Wood Products: Provide engineered wood products acceptable to authorities having jurisdiction and for which current model code research or evaluation reports exist that show compliance with building code in effect for Project.
 1. Allowable Design Stresses: Provide engineered wood products with allowable design stresses, as published by manufacturer, that meet or exceed those indicated. Manufacturer's published values shall be determined from empirical data or by rational engineering analysis and demonstrated by comprehensive testing performed by a qualified independent testing agency.

2.2 WOOD-PRESERVATIVE-TREATED LUMBER

- A. Preservative Treatment by Pressure Process: AWPA C2 except that lumber that is not in contact with the ground and is continuously protected from liquid water may be treated according to AWPA C31 with inorganic boron (SBX).

TECHNICAL SPECIFICATIONS FOR GLENDALE FIRE STATION
SECTION 06100 – ROUGH CARPENTRY

1. Preservative Chemicals: Acceptable to authorities having jurisdiction and containing no arsenic or chromium.
 2. For exposed items indicated to receive a stained or natural finish, use chemical formulations that do not require incising, contain colorants, bleed through, or otherwise adversely affect finishes.
- B. Kiln-dry lumber after treatment to a maximum moisture content of 19 percent. Do not use material that is warped or does not comply with requirements for untreated material.
- C. Mark lumber with treatment quality mark of an inspection agency approved by the ALSC Board of Review.
1. For exposed lumber indicated to receive a stained or natural finish, mark end or back of each piece.
- D. Application: Treat where in contact with concrete on CM4'S

2.3 DIMENSION LUMBER FRAMING

- A. Maximum Moisture Content: 19 percent.
- B. No. 2.
- C. Non-Load-Bearing, Interior Partitions: grade and the following species:
1. Mixed southern pine; SPIB.
 2. or WWPA.
 3. (south); NeLMA, WCLIB, or WWPA.
 4. NLGA.
 5. NeLMA.
 6. WCLIB or WWPA.
- D. Joists, Rafters, and Other Framing Not Listed Above: No. 2 grade and of the following species:
1. Southern pine; SPIB.

2.4 MISCELLANEOUS LUMBER

- A. General: Provide miscellaneous lumber indicated and lumber for support or attachment of other construction, including the following:

TECHNICAL SPECIFICATIONS FOR GLENDALE FIRE STATION
SECTION 06100 – ROUGH CARPENTRY

1. Blocking.
 2. Nailers.
 3. Furring.
 4. Grounds.
 5. Utility shelving.
- B. For items of dimension lumber size, provide No. 2 grade lumber with 19 percent maximum moisture content of any species.
- C. For items of dimension lumber size, provide No. 2 grade lumber with 19 percent maximum moisture content and of the following species:
1. Mixed southern pine; SPIB.
- D. For concealed boards, provide lumber with 19 percent maximum moisture content and any of the following species and grades:
1. Mixed southern pine, No. 2 grade; SPIB.
- E. For blocking not used for attachment of other construction, Utility, Stud, or No. 3 grade lumber of any species may be used provided that it is cut and selected to eliminate defects that will interfere with its attachment and purpose.
- F. For blocking and nailers used for attachment of other construction, select and cut lumber to eliminate knots and other defects that will interfere with attachment of other work.
- G. For furring strips for installing plywood or hardboard paneling, select boards with no knots capable of producing bent-over nails and damage to paneling.

2.5 PLYWOOD BACKING PANELS

- A. Telephone and Electrical Equipment Backing Panels: DOC PS 1, Exposure 1, C-D Plugged, in thickness indicated or, if not indicated, not less than ½-inch nominal thickness.

2.6 FASTENERS

- A. General: Provide fasteners of size and type indicated that comply with requirements specified in this Article for material and manufacture.
1. Where rough carpentry is exposed to weather, in ground contact, pressure-preservative treated, or in area of high relative humidity, provide fasteners.
- B. Nails, Brads, and Staples: ASTM F 1667.
- C. Power-Driven Fasteners: NES NER-272.

TECHNICAL SPECIFICATIONS FOR GLENDALE FIRE STATION
SECTION 06100 – ROUGH CARPENTRY

- D. Wood Screws: ASME B18.6.1.
- E. Lag Bolts: ASME B18.2.1.
- F. Bolts: Steel bolts complying with ASTM A 307, Grade A; with ASTM A 563 hex nuts and, where indicated, flat washers.
- G. Expansion Anchors: Anchor bolt and sleeve assembly of material indicated below with capability to sustain, without failure, a load equal to 6 times the load imposed when installed in unit masonry assemblies and equal to 4 times the load imposed when installed in concrete as determined by testing per ASTM E 488 conducted by a qualified independent testing and inspecting agency.
 - 1. Material: Carbon-steel components, zinc plated to comply with ASTM B 633, Class Fe/Zn 5.
 - 2. Material: Stainless steel with bolts and nuts complying with ASTM F 593 and ASTM F 594, Alloy Group 1 or 2.

2.7 METAL FRAMING ANCHORS

- A. Hold-Downs: Brackets for bolting to wall studs and securing to foundation walls with anchor bolts or to other hold-downs with threaded rods and designed with first of two bolts placed seven bolt diameters from reinforced base.
 - 1. Bolt Diameter: 5/8 inch.

2.8 MISCELLANEOUS MATERIALS

- A. Sill-Sealer Gaskets: Glass-fiber-resilient insulation, fabricated in strip form, for use as a sill sealer; 1-inch nominal thickness, compressible to 1/32 inch; selected from manufacturer's standard widths to suit width of sill members indicated.
- B. Sill-Sealer Gaskets: Closed-cell neoprene foam, ¼ inch thick, selected from manufacturer's standard widths to suit width of sill members indicated.
- C. Adhesives for Gluing, Furring, and Sleepers to Concrete or Masonry: Formulation complying with ASTM D 3498 that is approved for use indicated by adhesive manufacturer.
 - 1. Use adhesives that have a VOC content of 70 g/L or less when calculated according to 40 CFR 59, Subpart D (EPA Method 24).
- D. Water-Repellent Preservative: NWWDA-tested and -accepted formulation containing 3-iodo-2-propynyl butyl carbamate, combined with an insecticide containing chlorpyrifos as its active ingredient.

TECHNICAL SPECIFICATIONS FOR GLENDALE FIRE STATION
SECTION 06100 – ROUGH CARPENTRY
PART 3 - EXECUTION

3.1 INSTALLATION, GENERAL

- A. Set rough carpentry to required levels and lines, with members plumb, true to line, cut, and fitted. Fit rough carpentry to other construction; scribe and cope as needed for accurate fit. Locate, nailers, blocking, and similar supports to comply with requirements for attaching other construction.
- B. Framing Standard: Comply with AF&PA's "Details for Conventional Wood Frame Construction," unless otherwise indicated.
- C. Framing with Engineered Wood Products: Install engineered wood products to comply with manufacturer's written instructions.
- D. Metal Framing Anchors: Install metal framing to comply with manufacturer's written instructions.
- E. Do not splice structural members between supports, unless otherwise indicated.
- F. Provide blocking and framing as indicated and as required to support facing materials, fixtures, specialty items, and trim.
 - 1. Provide metal clips for fastening gypsum board or lath at corners and intersections where framing or blocking does not provide a surface for fastening edges of panels. Space clips not more than 16 inches o.c.
- G. Sort and select lumber so that natural characteristics will not interfere with installation or with fastening other materials to lumber. Do not use materials with defects that interfere with function of member or pieces that are too small to use with minimum number of joints or optimum joint arrangement.
- H. Comply with AWWPA M4 for applying field treatment to cut surfaces of preservative-treated lumber.
 - 1. Use inorganic boron for items that are continuously protected from liquid water.
 - 2. Use copper naphthenate for items not continuously protected from liquid water.
- I. Securely attach rough carpentry work to substrate by anchoring and fastening as indicated, complying with the following:
 - 1. NES NER-272 for power-driven fasteners.
 - 2. Table 2304.9.1, "Fastening Schedule," in ICC's International Building Code.
 - 3. Table 23-II-B-1, "Nailing Schedule," and Table 23-II-B-2, "Wood Structural Panel Roof Sheathing Nailing Schedule," in ICBO's Uniform Building Code.
 - 4. Table 2305.2, "Fastening Schedule," in BOCA's BOCA National Building Code.
 - 5. Table 2306.1, "Fastening Schedule," in SBCCI's Standard Building Code.

TECHNICAL SPECIFICATIONS FOR GLENDALE FIRE STATION
SECTION 06100 – ROUGH CARPENTRY

6. Table R602.3(1), “Fastener Schedule for Structural Members,” and Table R602.3(2), “Alternate Attachments,” in ICC’s International Residential Code for One- and Two-Family Dwellings.
 7. Table 602.3(1), “Fastener Schedule for Structural Members,” and Table 602.3(2), “Alternate Attachments,” in ICC’s International One- and Two-Family Dwelling Code.
- J. Use common wire nails, unless otherwise indicated. Select fasteners of size that will not fully penetrate members where opposite side will be exposed to view or will receive finish materials. Make tight connections between members. Install fasteners without splitting wood; do not countersink nail heads, unless otherwise indicated.

3.2 WALL AND PARTITION FRAMING INSTALLATION

- A. General: Provide single bottom plate and double top plates using members of 2-inch nominal thickness whose widths equal that of studs, except single top plate may be used for non-load-bearing partitions and for load-bearing partitions where framing members bearing on partition are located directly over studs. Fasten plates to supporting construction, unless otherwise indicated.
1. For exterior walls, provide 2-by-4-inch nominal size wood studs spaced 16” o.c., unless otherwise indicated.
 2. For interior partitions and walls, provide 2-by-4-inch nominal size wood studs spaced 24” o.c., unless otherwise indicated.
 3. Provide continuous horizontal blocking at midheight of partitions more than 96” high, using members of 2-inch nominal thickness and of same width as wall or partitions.
- B. Construct corners and intersections with three or more studs.
- C. Frame openings with multiple studs and headers. Provide nailed header members of thickness equal to width of studs. Support headers on jamb studs. Refer to plan

3.3 PROTECTION

- A. Protect wood that has been treated with inorganic boron (SBX) from weather. If, despite protection, inorganic boron-treated wood becomes wet, apply EPA-registered borate treatment. Apply borate solution by spraying to comply with EPA-registered label.
- B. Protect rough carpentry from weather. If, despite protection, rough carpentry becomes wet, apply EPA-registered borate treatment. Apply borate solution by spraying to comply with EPA-registered label.

END OF SECTION 06100

TECHNICAL SPECIFICATIONS FOR GLENDALE FIRE STATION
SECTION 06402 - INTERIOR ARCHITECTURAL WOODWORK

PART 1 - GENERAL

1.1 RELATED DOCUMENTS

- A. Drawings and general provisions of the Contract, including General and; Supplementary Conditions and Division 1 Specification Sections, apply to this Section.

1.2 SUMMARY

- A. This Section includes the following:

1. Interior standing and running trim.
2. Flush wood paneling and wainscots.
3. Interior frames and jambs.
4. Shop finishing interior woodwork

- B. Related Sections include the following:

1. Division 6 Section "Rough Carpentry" for wood furring, blocking, shims, and hanging strip required for installing woodwork and concealed within other construction before woodwork installation.
2. Division 12 "Wood Cabinets" and "Wood Veneer Cabinets"
3. Division 9 Section "Painting" for field finishing of interior architectural woodwork.

- A. Interior architectural woodwork includes wood furring, blocking, shims, and hanging strips for installing woodwork items, unless concealed within other construction before woodwork installation.

1.4 SUBMITTALS

- A. Product Data: For each type of product indicated, including cabinet hardware and accessories, handrail brackets, and finishing materials and processes.
- B. Shop Drawings: Show location of each item, dimensioned plans and elevations, large scale details, attachment devices, and other components.
1. Show locations and sizes of furring, blocking, and hanging strips, including concealed blocking and reinforcement specified in other Sections.

TECHNICAL SPECIFICATIONS FOR GLENDALE FIRE STATION
SECTION 06402 - INTERIOR ARCHITECTURAL WOODWORK

2. Show locations and sizes of cutouts and holes for plumbing fixtures, faucets, soap dispensers, and other items installed in architectural woodwork.
 3. Show veneer leaves with dimensions, grain direction, exposed face, and identification numbers indicating the flitch and sequence within the flitch for each leaf.
 4. Apply WIG-certified compliance label to first page of Shop Drawings.
- C. Samples for Initial Selection: Manufacturer's color charts consisting of units or sections of limits showing the full range of colors, textures, and patterns available for each type of material indicated.
1. Plastic laminates.
- D. Samples for Verification: For the following:
1. Lumber and panel products with shop-applied finish, 50 sq. in. (300 sq. cm) for lumber and 8 by 10 inches (200 by 250 mm) for panels, for each finish system and color, with 1/2 of exposed surface finished.
 2. Plastic-laminate-clad panel products, 8 by 10 inches (200 by 250 mm), for each type, color, pattern, and surface finish, with separate samples of unfaced panel product used for core.
 3. Exposed cabinet hardware and accessories, one unit for each type and finish.
- E. Qualification Data: For firms, and persons specified in "Quality Assurance" Article to demonstrate their capabilities and experience. Include lists of completed projects with project names and addresses, names and addresses of architects and owners, and other information specified.

1.5 QUALITY ASSURANCE

- A. Installer Qualifications: An experienced installer who has completed architectural woodwork similar in material, design, and extent to that indicated for this Project and whose work has resulted in construction with a record of successful in-service performance.
- B. Fabricator Qualifications: A firm experienced in producing architectural woodwork similar to that indicated for this Project and with a record of successful

TECHNICAL SPECIFICATIONS FOR GLENDALE FIRE STATION
SECTION 06402 - INTERIOR ARCHITECTURAL WOODWORK

in-service performance, as well as sufficient production capacity to produce required units.

- C. Source Limitations: Engage a qualified woodworking firm to assume undivided responsibility for production and' installation of interior architectural woodwork with sequence-matched wood veneers including wood doors where veneer matching includes door faces.
- D. Quality Standard: Unless otherwise indicated, comply with AWI's "Architectural. Woodwork Quality Standards" for grades of interior architectural woodwork, construction, finishes, and other requirements.
 - 1. Provide AWI Quality Certification Program labels indicating that woodwork complies with requirements of grades specified.

1.6 DELIVERY, STORAGE, AND HANDLING

- A. Do not deliver woodwork until painting and similar operations that could damage woodwork have been completed in installation areas. If woodwork must be stored in. other than installation areas, store only in areas where environmental conditions comply with requirements specified in "Project Conditions" Article.

1.7 PROJECT CONDITIONS

- A. Environmental Limitations: Obtain and comply with woodwork fabricator's and Installer's coordinated advice for optimum temperature and humidity conditions for woodwork during its storage and installation. Do not install woodwork until these conditions have been attained and stabilized so that woodwork will be within plus or minus 1.0 percent of optimum moisture content from date of installation through remainder of construction period.
- B. Field Measurements: Where woodwork is indicated to fit to other construction, verify dimensions of other construction by field measurements before fabrication and indicate measurements on Shop Drawings. Coordinate fabrication schedule with construction progress to avoid delaying the Work.
 - 1. Locate concealed framing, blocking, and reinforcements that support woodwork by field measurements before being enclosed and indicate measurements on Shop Drawings.
 - 2. Established Dimensions: Where field measurements cannot be made without delaying the Work, establish dimensions and proceed with fabricating woodwork without field measurements.. Provide allowance for trimming at site, and coordinate construction to ensure that actual

TECHNICAL SPECIFICATIONS FOR GLENDALE FIRE STATION
SECTION 06402 - INTERIOR ARCHITECTURAL WOODWORK

dimensions correspond to established dimensions.

1.8 COORDINATION

- A. Coordinate sizes and locations of framing, blocking, furring, reinforcements, and other related units of Work specified in other Sections to ensure that interior architectural woodwork can be supported and installed as indicated.
- B. Hardware Coordination: Coordinate architectural woodwork with all required millwork hardware.

PART 2 - PRODUCTS.

2.1 MATERIALS

- A. General: Provide materials that comply with requirements of the AWI quality standard for each type of woodwork and quality grade specified, unless otherwise indicated.
- B. Wood Species and Cut for Transparent Finish: Honduras Mahogany
- C. Wood Products: Comply with the following:
 - 1. Hardboard: AHAA 135.4.
 - 2. Medium-Density Fiberboard: ANSI A208.2.
 - 3. Particleboard: ANSI A208.1.
 - 4. Softwood Plywood: DOC PS 1.
 - 5. Hardwood Plywood and Face Veneers: HPVA HP-1.
- D. High-Pressure Decorative Laminate: NEMA LD 3, grades as indicated, or if not indicated, as required by woodwork quality standard.
 - 1. Manufacturer: Subject to compliance with requirements, provide high-pressure decorative laminates by one of the following:
 - a. As indicated on the drawings
- E. Adhesive for Bonding Plastic Laminate: Urea- Formaldehyde.

2.2 CABINET HARDWARE AND ACCESSORIES

- A. General: Provide cabinet hardware and accessory materials associated with architectural cabinets.

TECHNICAL SPECIFICATIONS FOR GLENDALE FIRE STATION
SECTION 06402 - INTERIOR ARCHITECTURAL WOODWORK

- B. Hardware Standard: Comply with BHMA A 156.9 for items indicated by referencing BHMA numbers or items referenced to this standard.
- C. Frameless Concealed Hinges (European Type): BHMA A156.9, B01602, [170] degrees of opening.
- D. Wire Pulls: Back mounted, 4 inches (100 mm) long, 5/16 inches (8 mm) in diameter.
- E. Adjustable Shelf Standards and Supports: BHMA A 156.9, 804071; with shelf rests, B04081.
- F. Drawer Slides: Side-mounted, full-extension, zinc-plated steel drawer slides with steel ball bearings, BHMAA156.9, B05091 and rated as required for use:
- G. Grommets for Cable Passage. through Countertops: [2-inch (51-mm)] 00, black, molded-plastic grommets and matching plastic caps with slot for wire passage.
- H. Exposed Hardware Finishes: For exposed hardware, provide finish that complies with BHMAA156.18 for BHMA finish number indicated. .
 - 1. Satin Stainless Steel: BHMA 630.
- I. For concealed hardware, provide manufacturer's standard finish that complies with product class requirements in BHMAA156.9.

2.3 INSTALLATION MATERIALS

- A. Furring, Blocking, Shims, and Hanging Strips: Softwood or hardwood lumber, kiln dried to less than 15 percent moisture content.
- B. Anchors: Select material, type, size, and finish required for each substrate for secure anchorage. Provide nonferrous-metal or hot-dip galvanized anchors and inserts on inside face of exterior walls and elsewhere as required for corrosion resistance. Provide toothed-steel or lead expansion sleeves for drilled-in-place anchors.

2.4 FABRICATION, GENERAL

- A. Interior Woodwork Grade: Provide Premium grade interior woodwork complying with the referenced quality standard.
- B. Wood Moisture Content: Comply with requirements of referenced quality

TECHNICAL SPECIFICATIONS FOR GLENDALE FIRE STATION
SECTION 06402 - INTERIOR ARCHITECTURAL WOODWORK

standard for wood moisture content in relation to ambient relative humidity during fabrication and in installation areas.

- C. Fabricate woodwork to dimensions, profiles, and details indicated.
- D. Complete fabrication, including assembly, finishing, and hardware application, to maximum extent possible, before shipment to Project site. Disassemble components only as necessary for shipment and installation. Where necessary for fitting at site, provide ample allowance for scribing, trimming, and fitting.
- E. Shop cut openings, to maximum extent possible, to receive hardware, appliances plumbing fixtures, electrical work, and similar items. Locate openings accurately and use templates or roughing-in diagrams to produce accurately sized and shaped openings. Sand edges of cutouts to remove splinters and burrs.
 - 1. Seal edges of openings in countertops with a coat of varnish.

2.5 INTERIOR STANDING AND RUNNING TRIM FOR TRANSPARENT FINISH

- A. Quality Standard: Comply with AWI Section 300.
- B. Grade: Premium.
- C. Backout or groove backs of flat trim members and kerf backs of other wide, flat members, except for members with ends exposed in finished work.
- D. Assemble casings in plant except where limitations of access to place of installation require field assembly. .
- E. Assemble moldings in plant to maximum extent possible. Miter comers in plant and prepare for field assembly with bolted fittings designed to pull connections together.
- F. Wood Species and Cut: Cherry, plain sliced.

2.9 FLUSH WOOD PANELING AND WAINSCOTS

- A. Quality Standard: Comply with AWI Section 500 requirements for flush wood paneling.
- B. Grade: Premium.
- C. Wood Species and Cut: Cherry, plain sliced.

TECHNICAL SPECIFICATIONS FOR GLENDALE FIRE STATION
SECTION 06402 - INTERIOR ARCHITECTURAL WOODWORK

- D. Panel-Matching Method: No matching between panels is required. Select and arrange panels for similarity of grain pattern and color between adjacent panels.

2.10 INTERIOR FRAMES AND JAMBS FOR TRANSPARENT FINISH

- A. Quality Standard: Comply with AWI Section 900.
- B. Grade: Premium.
- C. For frames or jambs wider than available lumber, use veneered construction. Do not glue for width.
- D. Wood Species and Cut: Cherry, plain sliced.
- E. Fire-Rated Interior Frames and Jambs: Products fabricated from fire-retardant particleboard or fire-retardant medium-density fiberboard with veneered, exposed surfaces and listed and labeled by a testing and inspecting agency acceptable to authorities having jurisdiction, for fire ratings indicated, based on testing according to NFPA 252.
 - 1. Test Pressure: Test at atmospheric pressure.
 - 2. Fire Rating: 20 minutes.

2.11 SHOP FINISHING

- A. Quality Standard: Comply with AWI Section 1500, unless otherwise indicated.
- B. General: Finish architectural woodwork at fabrication shop as specified in this Section. Defer only final touch up, cleaning, and polishing until after installation.
- C. Preparations for Finishing: Comply with referenced quality standard for sanding, filling countersunk fasteners, sealing concealed surfaces, and similar preparations for finishing architectural woodwork, as applicable to each unit of work.
 - 1. Backpriming: Apply one coat of sealer or primer, compatible with finish coats, to concealed surfaces of woodwork. Apply two coats to back of paneling and to end-grain surfaces. Concealed surfaces of plastic-laminate-clad woodwork do not require backpriming when surfaced with plastic laminate, backing paper, or thermoset decorative overlay.
- D. Transparent Finish: Comply with requirements indicated below for grade, finish system, staining, and sheen, with sheen measured on 60-degree gloss meter per ASTM D 523:

TECHNICAL SPECIFICATIONS FOR GLENDALE FIRE STATION
SECTION 06402 - INTERIOR ARCHITECTURAL WOODWORK

1. Grade: Premium.
2. Wash Coat for Stained Finish: Apply a vinyl wash coat to woodwork made from closed-grain wood before staining and finishing.
3. Open Finish for Open-Grain Woods: Do not apply filler to open-grain woods.
4. Filled Finish for Open-Grain Woods: After staining (if any), apply paste wood filler to open-grain woods and wipe off excess. Tint filler to match stained wood.
5. Sheen: Satin, 30-50.

PART 3- EXECUTION

3.1 PREPARATION

- A. Condition woodwork to average prevailing humidity conditions in installation areas before installation.
- B. Before installing architectural woodwork, examine shop-fabricated work for completion and complete work as required, including removal of packing and backpriming.

3.2 INSTALLATION

- A. Quality Standard: Install woodwork to comply with AWI Section 1700 for the same grade specified in Part 2 of this Section for type of woodwork involved. Delete paragraph above or below. Revise if installation grade is different.
- B. Install woodwork level, plumb, true, and straight. Shim as required with concealed shims. Install level and plumb (including tops) to a tolerance of 1/8 inch in 96 inches (3 mm in 2400 mm).
- C. Scribe and cut woodwork to fit adjoining work, and refinish cut surfaces and repair damaged finish at cuts.
- D. Fire-Retardant-Treated Wood: Handle, store, and install fire-retardant-treated wood to comply with recommendations of chemical treatment manufacturer, including those for adhesives used to install woodwork.
- E. Anchor woodwork to anchors or blocking built in or directly attached to substrates. Secure with countersunk, concealed fasteners and blind nailing as required for complete installation. Use fine finishing nails or finishing screws for exposed fastening, countersunk and filled flush with woodwork and matching final finish if transparent finish is indicated.

TECHNICAL SPECIFICATIONS FOR GLENDALE FIRE STATION
SECTION 06402 - INTERIOR ARCHITECTURAL WOODWORK

- F. Standing and Running Trim: Install with minimum number of joints possible, using full length pieces (from maximum length of lumber available) to greatest extent possible. Do not use pieces less than 36 inches (900 mm)] long, except where shorter single length pieces are necessary. Scarf running joints and stagger in adjacent and related members.
 - 1. Fill gaps, if any, between top of base and wall with plastic wood filler, sand smooth, and finish same as wood base, if finished.
 - 2. Install standing and running trim with no more variation from a straight line than 1/8 inch in 96 inches (3 mm in 2400 mm).
- J. Paneling: Anchor paneling to supporting substrate with concealed panel-hanger clips or as indicated on the drawings.
 - 1. Install flush paneling with no more than 1/16 inch in 96-inch (1.5 mm in 2400-mm) vertical cup or bow and 1/8 inch in 96-inch (3 mm in 2400-mm) horizontal variation from a true plane.
- K. Refer to Division 9 Sections for final finishing of installed architectural woodwork.

3.3 ADJUSTING AND CLEANING,

- A. Repair damaged and defective woodwork, where possible, to eliminate functional and visual defects; where not possible to repair, replace woodwork. Adjust joinery for uniform appearance.
- B. Clean, lubricate, and adjust hardware.
- C. Clean woodwork on exposed and semi-exposed surfaces. Touch up shop-applied finishes to restore damaged or soiled areas.

END OF SECTION 06402

TECHNICAL SPECIFICATIONS FOR GLENDALE FIRE STATION
SECTION 07210 - BUILDING INSULATION

PART 1 GENERAL

1.1 RELATED DOCUMENTS

- A. Drawings and general provisions of the Contract, including General and Supplementary Conditions and Division 1 Specification Sections, apply to this Section.
 - 1. This Section includes the following:
 - a. Building Insulation in batt form.
 - b. Safing insulation.
- B. Related Sections: The following Sections contain requirements that relate to this Section:
 - 1. Division 7 Section "Standing Seam Metal Roofing System" for insulation specified as part of roofing construction.
 - 2. Division 7 Section "Exterior Insulation"
 - 3. Division 9. Section "Gypsum. Board Assemblies" for insulation installed as part of metal framed wall and partition assemblies:

1.2 DEFINITIONS

- A, Thermal Resistivity: Where the thermal resistivity of insulation products are designated by "r-values," they represent the reciprocal of thermal conductivity (k-values). Thermal conductivity is the rate of heat flow through a homogenous material exactly 1 inch thick. Thermal resistivities are expressed by the temperature difference in degrees F between the two exposed faces required to cause one BTU to flow through one square foot per hour at mean temperatures indicated.

1.3 SUBMITTALS

- A. General: Submit each item in this Article according to the Conditions of the Contract and Division 1 Specification Sections.
- B. Product Data for each type of insulation product specified.
 - 1. Product test reports from and based on tests performed by a qualified independent testing agency evidencing compliance of insulation products with specified requirements including those for thermal resistance, fire-

TECHNICAL SPECIFICATIONS FOR GLENDALE FIRE STATION
SECTION 07210 - BUILDING INSULATION

test-response characteristics, water-vapor transmission, water absorption, and other properties, based on comprehensive testing of current products.

1.4 QUALITY ASSURANCE

- A. Single-Source Responsibility for Insulation Products: Obtain each type of building insulation from a single source with resources to provide products complying with requirements indicated without delaying the Work.
- B. Fire-Test-Response Characteristics: Provide insulation and related materials with the fire-test response characteristics indicated on Drawings or specified elsewhere in this Section as determined by testing identical products per test method indicated below by UL or another testing and inspecting agency acceptable to authorities having jurisdiction. Identify materials with appropriate markings of applicable testing and inspecting agency.
 - 1. Surface-Burning Characteristics: ASTM E 84.
 - 2. Fire-Resistance Ratings: ASTM E 119.
 - 3. Combustion Characteristics: ASTM E 136.

1.5 DELIVERY, STORAGE, AND HANDLING

- A. Protect insulation materials from physical damage and from deterioration by moisture, soiling, and other sources. Store inside and in a dry location. Comply with manufacturer's written instructions for handling, storing, and protecting during installation.

PART 2 - PRODUCTS

2.1 MANUFACTURERS

- A. Manufacturers: Subject to compliance with requirements, provide insulation products by one of the following:
 - 1. Glass-Fiber Insulation:
 - a. Certain Teed Corporation.
 - b. Manville: Building Insulations Div., Manville Sales Corp.
 - c. Owens-Corning Fiberglas Corporation.
 - 2. Semi- Refractory Fiber Insulation:
 - a. Cafco Industries Ltd.
 - b. USG: Thermafiber Div., USG Interiors, Inc.

TECHNICAL SPECIFICATIONS FOR GLENDALE FIRE STATION
SECTION 07210 - BUILDING INSULATION
2.2 INSULATING MATERIALS

- A. General: Provide insulating materials that comply with requirements and with referenced standards.
 - 1. Preformed Units: Sizes to fit applications indicated; selected from manufacturer's standard thicknesses, widths, and lengths.
- B. Faced Mineral-Fiber Blanket Insulation: Thermal insulation combining mineral fibers of type described below with thermosetting resins to comply with ASTM C 665, Type III, Class A (blankets with reflective vapor-retarder membrane facing and flame spread of 25 or less); with foil-scrim-kraft, foil-scrim, or foil-scrim-polyethylene vapor-retarder membrane on 1 face.
 - 1. Mineral-Fiber Type: Fibers manufactured from glass or slag.
 - 2. Surface Burning Characteristics: Maximum flame spread and smoke developed values of 25 and 50 respectively.
- C. Flanged Units: Provide blankets fabricated with facing incorporating 4-inch-wide flanges along edges for attachment to framing members.

2.3 SAFING INSULATION AND ACCESSORIES

- A. Semi-Refractory Fiber Board Safing Insulation: Semirigid boards designed for use as fire stop at openings between edge of slab and exterior wall panels, produced by combining slag-wool fibers with thermosetting resin binders to comply with ASTM C612, Class 1 and 2; nominal density of 4.0 pcf; passing ASTM E 136 for combustion characteristics; r-value of 4.0 at 75 deg F (23.9 deg C).
- B. Calking Compound: Material approved by manufacturer of safing insulation for sealing joint between foil backing of safing insulation and edge of concrete floor slab against penetration of smoke.
- C. Safina Clips: Galvanized steel safing clips approved by manufacturer of safing insulation for holding safing insulation in place.

2.4 AUXILIARY INSULATING MATERIALS

- A. Adhesive *for* Bonding Insulation: Product with demonstrated capability to bond insulation or mechanical anchors securely to substrates indicated without damaging or corroding either insulation, anchors, or substrates.

TECHNICAL SPECIFICATIONS FOR GLENDALE FIRE STATION
SECTION 07210 - BUILDING INSULATION
PART 3 - EXECUTION

3.1 EXAMINATION

- A. Examine substrates and conditions, with Installer present, for compliance with requirements of Sections in which substrates and related work are specified and to determine if other conditions affecting performance of insulation are satisfactory. Do not proceed with installation until, unsatisfactory conditions have been corrected.

3.2 PREPARATION

- A. Clean substrates of substances harmful to insulations or vapor retarders, including removing projections capable of puncturing vapor retarders or that interfere with insulation attachment.
- B. Close off openings in cavities receiving poured-in-place insulation to prevent escape of insulation. Provide bronze or stainless-steel screens (inside) where openings must be maintained for drainage or ventilation.

3.3 INSTALLATION - GENERAL

- A. Comply with insulation manufacturer's written instructions applicable to products and application indicated. If printed instructions are not available or do not apply to project conditions, consult manufacturer's technical representative for specific recommendations before proceeding with installation of insulation.
- B. Extend insulation in thickness indicated to envelop entire area to be insulated. Cut and fit tightly around obstructions and fill voids with insulation. Remove projections that interfere with placement. .
- C. Apply single laver of insulation of required thickness; unless otherwise shown or required to make up total thickness indicated.

3.4 INSTALLATION OF GENERAL BUILDING INSULATION

- A. Apply insulation units to substrates by method indicated, complying with manufacturer's written instructions. If no specific method is indicated, bond units to substrate with adhesive or use mechanical anchorage to provide permanent placement and support of units.
- B. Set vapor-retarder-faced units with vapor retarder to warm side of construction, unless otherwise indicated. Do not obstruct ventilation spaces, except for firestopping.

TECHNICAL SPECIFICATIONS FOR GLENDALE FIRE STATION
SECTION 07210 - BUILDING INSULATION

- C. Set reflective foil-faced units with not less than 0.75-inch (19-mm) air space in front of foil as indicated.

3.5 INSTALLATION OF SAFING INSULATION

- A. Install safing insulation to fill gap between edge of concrete floor slab and back of exterior spandrel panels on sating clips spaced as needed to support insulation, but not further apart than 24 inches (610 mm) o.c. Cut safing insulation wider than gap to be filled to ensure compression fit and seal joint between insulation and edge of slab with calking approved by sating insulation manufacturer for this purpose. Leave no voids in completed installation.

3.6 PROTECTION

- A. General: Protect installed insulation and vapor retarders from damage due to harmful weather exposures, physical abuse and other causes. Provide temporary coverings or enclosures where insulation is subject to abuse and cannot be concealed and protected by permanent construction immediately after installation.

END OF SECTION 07210

TECHNICAL SPECIFICATIONS FOR GLENDALE FIRE STATION
SECTION 07620 - SHEET METAL FLASHING AND TRIM

PART 1 - GENERAL

1.1 RELATED DOCUMENTS

- A. Drawings and general provisions of the Contract, including General and Supplementary Conditions and Division 1 Specification Sections, apply to this Section.

1.2 SUMMARY

- A. This Section includes sheet metal flashing and trim in the following categories:
 - 1. Exposed trim, gravel stops, and fasciae.
 - 2. Copings.
 - 3. Metal flashing.
 - 4. Reglets

1.3 PERFORMANCE REQUIREMENTS

- A. General: Install sheet metal flashing and trim to withstand wind loads structural movement, thermally induced movement, and exposure to weather without failing.

1.4 SUBMITTALS

- A. General: Submit each item in this Article according to the Conditions of the Contract and Division 1 Specification Sections.
- B. Product Data including manufacturer's material and finish data, installation instructions, and general recommendations for each specified flashing material and fabricated product.
- C. Shop Drawings of each item specified showing layout, profiles, methods of joining, and anchorage details.
- D. Samples of sheet metal flashing, trim, and accessory items, in the specified finish. Where finish involves normal color and texture variations, include Sample sets composed of 2 or more units showing the full range of variations expected.
 - 1. 12-inch- (300-mm-) long Samples of factory-fabricated products exposed as finished Work. Provide complete with specified factory finish.

TECHNICAL SPECIFICATIONS FOR GLENDALE FIRE STATION
SECTION 07620 - SHEET METAL FLASHING AND TRIM

- E. Qualification data for firms and persons specified in the "Quality Assurance" Article to demonstrate their capabilities and experience. Include lists of completed projects with project names and addresses, names and addresses of architects and owners, and other information specified.

1.5 QUALITY ASSURANCE

- A. Installer Qualifications: Engage an experience Installer who has completed sheet metal flashing and trim work similar in material, design, and extent to that indicated for this Project and with a record of successful in-service performance.

1.6 PROJECT CONDITIONS

- A. Coordinate Work of this Section with interfacing and adjoining. Work for proper sequencing of each installation. Ensure best possible weather resistance, durability of Work, and protection of materials and finishes.

PART 2 - PRODUCTS

2.1 METALS

- A. Galvanized Steel Sheet: ASTM A 653, G90 (ASTM A653 M, 2275) commercial quality, lock forming quality, hot dipped galvanized, mill phosphatized for painting, not less than 0.0396 inch (1.0mm) thick.
 - 1. Note that all exposed metal trim and flashing to be prefinished to match custom color as selected by Architect.

2.2 REGLETS

- A. General: Units of type, material, and profile indicated, formed to provide secure interlocking of separate reglet and counterflashing pieces and compatible with flashing indicated.
- B. Surface-Mounted Type: Provide with slotted holes for fastening to substrate, with neoprene or other suitable weatherproofing washers, and with channel for sealant at top edge.
- C. Masonry Type: Provide with offset top flange for embedment in masonry mortar joint.
- D. Flexible Flashing Retainer: Provide resilient plastic or rubber accessory to secure flexible flashing in reglet where clearance does not permit use of standard metal counterflashing or where Drawings show reglet without metal counterflashing.

TECHNICAL SPECIFICATIONS FOR GLENDALE FIRE STATION
SECTION 07620 - SHEET METAL FLASHING AND TRIM

- E. Counterflashina Wind-Restraint Clips: Provide clips to be installed before counterflashing to prevent wind uplift of the counterflashing lower edge.
 - 1. Material: Galvanized steel, 0.0217 inch (0.55 mm) thick.
- F. Manufacturers: Subject to compliance with requirements, provide products by one of the following or owner's selection:
 - Fry Reglet Corporation.
 - Hickman: W.P. Hickman Co.

2.3 MISCELLANEOUS MATERIALS AND ACCESSORIES,

- A. Solder: ASTM B 32, Grade Sn50, used with rosin flux, solvent type.
- B. Fasteners: Same metal as sheet metal flashing or other noncorrosive metal as recommended by sheet metal manufacturer. Match finish of exposed heads with material being fastened.
- C. Elastomeric Sealant: Generic type recommended by sheet metal manufacturer and fabricator of components being sealed and complying with, requirements for joint sealants as specified in Division 7 Section "Joint Sealant".
- D. Asphalt Mastic: SSPC-Paint 12, solvent-type asphalt mastic nominally free of sulfur and containing no asbestos fibers, compound for 15-mil (0.4-mm) dry film thickness per coat.
- E. Metal Accessories: Provide sheet metal clips, straps, anchoring devices, and similar accessory units as required for installation of Work, matching or compatible with material being installed; noncorrosive; size and thickness required for performance.
- R. Roofing Cement: ASTM D 4586, Type I, asphalt based, containing no asbestos fibers.

2.4 FABRICATION, GENERAL

- A. Sheet Metal Fabrication, Standard: Fabricate sheet metal flashing and trim to comply with recommendations of SMACNA's "Architectural Sheet Metal Manual" that apply to the design, dimensions, metal, and other characteristics of the item indicated below.

TECHNICAL SPECIFICATIONS FOR GLENDALE FIRE STATION
SECTION 07620 - SHEET METAL FLASHING AND TRIM

- B. Comply with details shown on the drawings to fabricate sheet metal flashing and trim and gutters and downspouts that fit substrates and result in waterproof and weather-resistant performance once installed. Verify shapes and dimensions of surfaces to be covered before fabricating sheet metal.
- C. Form exposed sheet metal Work that is without excessive oil canning, buckling, and tool marks and that is true to line and levels indicated, with exposed edges folded back to form hems.
- D. Seams: Fabricate nonmoving seams in sheet metal with flat-lock seams. Tin edges to be seamed, form seams, and solder.
- E. Sealed Joints: Form nonexpansion, but movable, joints in metal to accommodate elastomeric sealant to comply with SMACNA standards.
- F. Separate metal, from noncompatible metal or corrosive substrates by coating concealed surfaces, at locations of, contact with asphalt mastic or other permanent separation as recommended by manufacturer.
- G. Conceal fasteners and expansion provisions where possible. Exposed fasteners are not allowed on faces of sheet metal exposed to public view.
- H. Fabricate cleats and attachment devices from same material as sheet metal component being anchored or from compatible, noncorrosive metal recommended by sheet metal manufacturer.
- I. Size: As recommended by SMACNA manual or sheet metal manufacturer for application but never less than thickness of metal being secured.

PART 3 - EXECUTION

3.1 EXAMINATION

- A. Examine substrates and conditions under which sheet metal flashing and trim are to be installed and verify that Work may properly commence. Do not proceed with installation until unsatisfactory conditions have been corrected.

3.2 INSTALLATION

- A. General: Unless otherwise indicated, install sheet metal flashing and trim to comply with performance requirements, manufacturer's installation instructions, and SMACNA's "Architectural Sheet Metal Manual". Anchor units of Work securely in place by methods indicated, providing for thermal expansion of metal

TECHNICAL SPECIFICATIONS FOR GLENDALE FIRE STATION
SECTION 07620 - SHEET METAL FLASHING AND TRIM

units; conceal fasteners where possible, and set units true to line and level as indicated, Install Work with laps, joints, and seams that will be permanently watertight and weatherproof.

- B. Install exposed sheet metal Work that is without excessive oil canning, buckling, and tool marks and that is true to line and levels indicated, with exposed edges folded back to form hems. Install sheet metal flashing and trim to fit substrates and to result in waterproof and weather-resistant performance. Verify shapes and dimensions of surfaces to be covered before fabricating sheet metal.
- C. Roof-Edge Flashings: Secure metal flashings at roof edges according to FM Loss Prevention Data Sheet 1-49 for specified wind zone.
- D. Expansion Provisions: Provide for thermal expansion of exposed sheet metal Work. Space movement joints at maximum of 10 feet (3 m) with no joints allowed within 24 inches (610 mm) of corner or intersection. Where lapped or bayonet-type expansion provisions in Work cannot be used or would not be sufficiently weatherproof and waterproof, form expansion joints of intermeshing hooked flanges, not less than 1 inch (25 mm) deep, filled with mastic sealant (concealed within joints).
- E. Soldered Joints: Clean surfaces to be soldered, removing oils and foreign matter. Pre-terminated edges of sheets to be soldered to a width of 1-1/2 inches (38 mm), except where pre-terminated surface would show in finished Work.
- F. Sealed Joints: Form nonexpansion, but movable, joints in metal to accommodate elastomeric sealant to comply with SMACNA standards. Fill joint with sealant and form metal to completely conceal sealant.
 - 1. Use joint adhesive for nonmoving joints specified not to be soldered.
- G. Separations: Separate metal from non compatible metal or corrosive substrates by coating concealed surfaces, at locations of contact, with asphalt mastic or other permanent separation as recommended by manufacturer.
 - 1. Install relets to receive counterflashing according to the following requirements:
 - a. Where indicated on the Contract Documents (drawings).
- H. Counterflashings: Coordinate installation of counterflashings with installation of assemblies to be protected by counterflashing. Install counterflashings in reglets or receivers. Secure in a waterproof manner by means of snap-in installation and sealant, lead wedges and sealant, interlocking folded seam, or blind rivets and

TECHNICAL SPECIFICATIONS FOR GLENDALE FIRE STATION
SECTION 07620 - SHEET METAL FLASHING AND TRIM

sealant. Lap counterflashing joints a minimum of 2 inches (50 mm) and bed with sealant.

- I. Equipment Support Flashing: Coordinate equipment support flashing installation with roofing and equipment installation. Weld or seal flashing to equipment support member.
- J. Roof-Penetration Flashing: Coordinate roof-penetration flashing installation with roofing and installation of items penetrating roof. Install flashing as follows:
 - 1. Turn lead flashing down inside vent piping, being careful not to block vent piping with flashing.
 - 2. Seal and clamp flashing to pipes penetrating roof, other than lead flashing on vent piping.

3.3 CLEANING AND PROTECTION

- A. Clean exposed metal surfaces, removing substances that might cause corrosion of metal or deterioration of finishes.
- B. Provide final protection and maintain conditions that ensure sheet metal flashing and trim Work during construction is without damage or deterioration other than natural weathering at the time of Substantial Completion.

END OF SECTION 07620

TECHNICAL SPECIFICATIONS FOR GLENDALE FIRE STATION
SECTION 07901 - JOINT SEALANTS

PART 1 - GENERAL

1.1 RELATED DOCUMENTS

- A. Drawings and general provisions of Contract, including General and Supplementary Conditions and Division 1 Specification Sections, apply to this Section.

1.2 SUMMARY

- A. This Section includes joint sealants for the following locations:
1. Exterior joints in vertical surfaces and nontraffic horizontal surfaces as indicated below:
 - a. Control and expansion joints in cast-in-place concrete.
 - b. Control and expansion joints in unit masonry.
 - c. Joints between different materials listed above.
 - d. Perimeter joints between materials listed above and frames of doors and windows.
 - e. Control and expansion joints in ceiling and overhead surfaces.
 - f. Other joints as indicated.
 2. Exterior joints in horizontal traffic surfaces as indicated below:
 - a. Control, expansion, and isolation joints in cast-in-place concrete slabs.
 - b. Joints between different materials listed above.
 - c. Other joints as indicated.
 3. Interior joints in vertical surfaces and horizontal nontraffic surfaces as indicated below:
 - a. Perimeter joints of exterior openings where indicated.
 - b. Perimeter joints between interior wall surfaces and frames of interior doors, windows, and elevator entrances.
 - c. Perimeter of toilet fixtures.
 - d. Other joints as indicated.
 4. Interior joints in horizontal traffic surfaces as indicated below:

TECHNICAL SPECIFICATIONS FOR GLENDALE FIRE STATION
SECTION 07901 - JOINT SEALANTS

- a. Control and expansion joints in cast-in-place concrete slabs.
- b. Control and expansion joints in tile flooring.
- c. Other joints as indicated.

5. Related Sections: The following Sections contain requirements that relate to this Section:

- a. Division 7 Section Flashing and Sheet Metal" for sealing joints related to flashing and sheet metal for roofing.
- b. Division 9 Section "Gypsum Drywall" for sealing concealed perimeter joints of gypsum board partitions to reduce sound transmission.
- c. Division 9 Section "Acoustical Panels" for sealing edge moldings at perimeter of acoustical ceilings.
- d. Division 9 Section "Tile" for sealing tile joints.

1.3 SYSTEM PERFORMANCE REQUIREMENTS

- A. Provide elastomeric joint sealants that have been produced and installed to establish and to maintain watertight and airtight continuous seals without causing staining or deterioration of joint substrates.
- B. Provide joint sealants for interior applications that have been produced and installed to establish and maintain airtight continuous seals that are water resistant and cause no staining or deterioration of joint substrates.

1.4 SUBMITTALS

- A. General: Submit the following in accordance with Conditions of Contract and Division 1 Specification Sections.
 1. Product data from manufacturers for each joint sealant product required.
 - a. Certification by joint sealant manufacturer that sealants plus the primers and cleaners required for sealant installation comply with local regulations controlling use of volatile organic compounds.
 2. Samples for initial selection purposes in form of manufacturers standard bead samples, consisting of strips of actual products showing full range of colors available, for each product exposed to view.
 3. Samples for verification purposes of each type and color of joint sealant required. Install joint sealant samples in 1/2-inch-wide joints formed between two 6-inch-long strips of material matching the appearance of exposed surfaces adjacent to joint sealants.

TECHNICAL SPECIFICATIONS FOR GLENDALE FIRE STATION
SECTION 07901 - JOINT SEALANTS

- B. Qualification data complying with requirements specified in "Quality Assurance" article. Include list of completed projects with project names addresses, names of Architects and Owners, plus other information specified.
 - 1. Product test reports for each type of joint sealants indicated, evidencing compliance with requirements specified.

1.5 QUALITY ASSURANCE

- A. Installer Qualifications: Engage an experienced Installer who has completed joint sealant applications similar in material, design, and extent to that indicated for Project that have resulted in construction with a record of successful in-service performance.
- B. Single Source Responsibility for Joint Sealant Materials: Obtain joint sealant materials from a single manufacturer for each different product required.

1.6 DELIVERY, STORAGE, AND HANDLING

- A. Deliver materials to Project site in original unopened containers or bundles with labels indicating manufacturer, product name and designation, color, expiration period for use, pot life, curing time, and mixing instructions for multi component materials.
- B. Store and handle materials in compliance with manufacturer's recommendations to prevent their deterioration or damage due to moisture, high or low temperatures, contaminants, or other causes.

1.7 PROJECT CONDITIONS

- A. Environmental Conditions: Do not proceed with installation of joint sealants under the following conditions:
 - 1. When ambient and substrate temperature conditions are outside the limits permitted by joint sealant manufacturer.
 - 2. When joint substrates are wet
- B. Joint Width Conditions: Do not proceed with installation of joint sealants where joint widths are less than allowed by joint sealant manufacturer for application indicated.
- C. Joint Substrate Conditions: Do not proceed with installation of joint sealants until contaminants capable of interfering with their adhesion are removed from joint

TECHNICAL SPECIFICATIONS FOR GLENDALE FIRE STATION
SECTION 07901 - JOINT SEALANTS
substrates.

1.8 SEQUENCING AND SCHEDULING

- A. Sequence installation of joint sealants to occur not less than 21 nor more than 30 days after completion of waterproofing, unless otherwise indicated.

PART 2 - PRODUCTS

2.1 MATERIALS. GENERAL

- A. Compatibility: Provide joint sealants, joint fillers, and other related materials that are compatible with one another and with joint substrates under conditions of service and application, as demonstrated by sealant manufacturer based on testing and field experience.
 - 1. Colors: Provide color of exposed joint sealants to comply with the following:
 - a. Provide selections made by Architect from manufacturer's full range of standard colors for products of type indicated.

2.2 ELASTOMERIC JOINT SEALANTS

- A. Elastomeric Sealant Standard: Provide manufacturer's standard chemically curing elastomeric sealants that comply with ASTM C 920.

2.3 ELASTOMERIC JOINT SEALANT DATA

Elastomeric Joint sealant Designation: (ES1)

Base Polymer: Urethane

Type: S (single component).

Grade: NS (nonsag).

Uses Related to Exposure: T(traffic) and NT(nontraffic)

Uses Related to Joint Substrates: M, G, A, and as applicable to joint substrates indicated, O.

Products: Subject to compliance, provide one of the following:

One-Part Nonsag Urethane Sealant for Use NT:

"DynatroII"; Pecora Corporation

"Sonolastic NP"; Sonneborn Building Products Division.

Rexnord Chemical Products, Inc.

" Dymonic"; Tremco, Inc.

TECHNICAL SPECIFICATIONS FOR GLENDALE FIRE STATION
SECTION 07901 - JOINT SEALANTS

One-Part Nonsag-Urethane Sealant for Use T:

"Perrnapol RC-1"; Products Research. & Chemical Corporation
"Sikaflex-Ia"; Sika Corporation.

2.4 SOLVENT-RELEASE-CURING JOINT SEALANTS

- A. Acrylic Sealant: Manufacturer's standard one-part, nonsag, solvent-release-curing acrylic terpolymer sealant complying with AAMA 808.3 or FS TT-S-00230 or both, with capability when tested for adhesion and cohesion under maximum cyclic movement per ASTM C 719, to withstand the following percentage change in joint width existing at time of application and remain adhered to joint substrates indicated for Project without failing cohesively:

12-1/2 percent movement in both extension and compression for a total of 25 percent

- B. Butyl Sealant: Manufacturer's standard one-part, nonsag, solvent-release-curing, polymerized butyl sealant complying with ASTM C 1085 and formulated with minimum of 75 percent solids to be nonstaining, paintable, and have a tack-free time of 24 hours or less.
- C. Pigmented Narrow Joint Sealant: Manufacturer's standard, solvent-release-curing, pigmented synthetic rubber sealant complying with AAMA 803.3 and formulated for sealing joints 3/16 inch or smaller in width.
- D. Available Products: Subject to compliance with requirements, solvent-release-curing joint sealants that may be incorporated in the Work include, but are not limited to, the following:

Acrylic Sealant:

"60+Unicrylic," Pecora Corp.
"PTI738," Protective Treatments, Inc.
"PTI767," Protective Treatments, Inc.
"Mono," Tremco, Inc.

Butyl Sealant:

"BG-158," Pecora Corp.
"PTI757," Protective Treatments, Inc.
"Sonneborn Multi-Purpose Sealant," Sonneborn Building Products Div., ChemRex, Inc.

TECHNICAL SPECIFICATIONS FOR GLENDALE FIRE STATION
SECTION 07901 - JOINT SEALANTS

"Tremco Butyl Sealant," Tremco, Inc.

Pigmented Narrow Joint Sealants:

"PTI 200," Protective Treatments, Inc.

2.5 LATEX JOINT SEALANTS

- A. General: Provide manufacturer's standard one-part, nonisag, mildew-resistant, paintable-latex sealant of formulation indicated that is recommended for exposed applications on interior and protected exterior locations and that accommodates indicated percentage change in joint width existing at time of installation without failing either adhesively or cohesively.
- B. Acrylic-Emulsion Sealant: Provide product complying with ASTM C 834 that accommodates joint movement of not more than 5 percent in both extension and compression for a total of 10 percent.
- C. Silicone Emulsion Sealant: Provide product complying with ASTM C 834 and, except for weight loss measured per ASTM C 792, with ASTM C 920 that accommodates joint movement of not more than 25 percent in both extension and compression for a total of 50 percent.
- D. Available Products: Subject to compliance with requirements, latex joint sealants that may be incorporated in the Work include, but are not limited to, the following:

Acrylic-Emulsion Sealant:

"AC-20," Pecora Corp.

"Sonolac," Sonneborn Building Products Div., ChemRex, Inc.

"Tremco Acrylic Latex 834," Tremco, Inc.

Silicone-Emulsion Sealant:

"Trade Mate Paintable Glazing Sealant," Dow Coming Corp.

2.6 ACOUSTICAL JOINT SEALANTS

- A. Acoustical Sealant: Manufacturer's standard nonsag, paintable, nonstaining latex sealant complying with ASTM C 834 and the following requirements:
 - 1. Product is effective in reducing airborne sound transmission through perimeter joints and openings in building construction as demonstrated by

TECHNICAL SPECIFICATIONS FOR GLENDALE FIRE STATION
SECTION 07901 - JOINT SEALANTS

testing representative assemblies per ASTM E90.

2. Product has flame spread and smoke developed ratings of less than 25 per ASTM E 84.

- B. Acoustical Sealant for Concealed Joints: Manufacturer's standard, nondrying, nonhardening, nonskinning, nonstaining, gunnable, synthetic rubber sealant recommended for sealing interior concealed joints to reduce transmission of airborne sound.

- C. Available Products: Subject to compliance with requirements, acoustical joint sealants that may be incorporated in the Work include, but are not limited to, the following:

Acoustical Sealant:

"SHEETROCK Acoustical Sealant,"; United States Gypsum Co;
"AC-20 FTR Acoustical and Insulation Sealant," PeCora Corp.

Acoustical Sealant for Concealed Joints:

"BA-98," Pecora Corp.
"Tremco Acoustical Sealant," Tremco, Inc.

2.7 JOINT SEALANT BACKING

- A. General: Provide sealant backings of material and type that are nonstaining; are compatible with joint substrates, sealants, primers and other joint fillers; and are approved for applications indicated by sealant manufacturer based on field experience and laboratory testing.

- B. Plastic Foam Joint Fillers: Preformed, compressible, resilient, nonstaining, nonwaxing, nonextruding strips of flexible plastic foam of material indicated below and of size, shape, and density to control sealant depth and otherwise contribute to producing optimum sealant performance:
 1. Open-cell polyurethane foam.
 2. Closed-cell polyethylene foam, nonabsorbent to liquid water and gas, nonoutgassing in unruptured state.
 3. Proprietary, reticulated, closed-cell polymeric foam, nonoutgassing, with a density of 2.5 pcf and tensile strength of 35 psi per ASTM D 1623; and with water absorption less than 0.02 gms/cc per ASTM C 1083.
 4. Any material indicated above.

- C. Elastomeric Tubing Joint Fillers: Neoprene, butyl, EPDM, or silicone tubing

TECHNICAL SPECIFICATIONS FOR GLENDALE FIRE STATION
SECTION 07901 - JOINT SEALANTS

complying with ASTM D 1056, nonabsorbent to water and gas, capable of remaining resilient at temperatures down to -26 deg F (-32 deg C). Provide products with low compression set and of size and shape to provide a secondary seal, to control sealant depth, and otherwise contribute to optimum sealant performance.

- D. Bond-Breaker Tape: Polyethylene tape or other plastic tape as recommended by sealant manufacturer for preventing sealant from adhering to rigid, inflexible joint filler materials or joint surfaces at back of joint where such adhesion would result in sealant failure. Provide self-adhesive tape where applicable.

2.8 MISCELLANEOUS MATERIALS

- A. Primer: Material recommended by joint sealant manufacturer where required for adhesion of sealant to joint substrates indicated; as determined from preconstruction joint sealant-substrate tests and field tests.
- B. Cleaners for Nonporous Surfaces: Chemical cleaners acceptable to manufacturers of sealants and sealant backing materials, free of oily residues or other substances capable of staining or harming in any way joint substrates and adjacent nonporous surfaces, and formulated to promote optimum adhesion of sealants with joint substrates.
- C. Masking Tape: Nonstaining, nonabsorbent material compatible with joint sealants and surfaces adjacent to joints.

PART 3 - EXECUTION

3.1 EXAMINATION

- A. Examine joints indicated to receive joint sealants, with Installer present, for compliance with requirements for joint configuration, installation tolerances, and other conditions affecting joint sealant performance. Do not proceed with installation of joint sealants until unsatisfactory conditions have been corrected.

3.2 PREPARATION

- A. Surface Cleaning of Joints: Clean out joints immediately before installing joint sealants to comply with recommendations of joint sealant manufacturer and the following requirements:
 - 1. Remove all foreign material from joint substrates that could interfere with adhesion of joint sealant, including dust, paints (except for permanent, protective coatings tested and approved for sealant adhesion and

TECHNICAL SPECIFICATIONS FOR GLENDALE FIRE STATION
SECTION 07901 - JOINT SEALANTS

compatibility by sealant manufacturer), old joint sealants, oil, grease, waterproofing, water repellents, water, surface dirt, and frost.

2. Clean concrete masonry, unglazed surfaces of ceramic tile, and similar porous joint substrate surfaces by brushing, grinding, blast cleaning, mechanical abrading, or a combination of these methods to produce a clean, sound substrate capable of developing optimum bond with joint sealants. Remove loose particles remaining from above cleaning operations by vacuuming or blowing out joints with oil-free compressed air.
 3. Remove laitance and form release agents from concrete.
 4. Clean metal, glass, porcelain enamel, glazed surfaces of ceramic tile, and other nonporous surfaces with chemical cleaners or other means that do not stain, harm substrates, or leave residues capable of interfering with adhesion of joint sealants.
- B. Joint Priming: Prime joint substrates where indicated or where recommended by joint sealant manufacturer based on preconstruction joint sealant-substrate tests or prior experience. Apply primer to comply with joint sealant manufacturer's recommendations. Confine primers to areas of joint sealant bond; do not allow spillage or migration onto adjoining surfaces.
- C. Masking Tape: Use masking tape where required to prevent contact of sealant with adjoining surfaces that otherwise would be permanently stained or damaged by such contact or by cleaning methods required to remove sealant smears. Remove tape immediately after tooling without disturbing joint seal.

3.3 INSTALLATION OF JOINT SEALANTS

- A. General: Comply with joint sealant manufacturer's printed installation instructions applicable to products and applications indicated, except where more stringent requirements apply.
1. Elastomeric Sealant Installation Standard: Comply with recommendations of ASTM C 962 for use of joint sealants as applicable to materials, applications, and conditions indicated.
 2. Solvent-Release-Curing Sealant Installation Standard: Comply with requirements of ASTM C 804 for use of solvent-release-curing sealants.

TECHNICAL SPECIFICATIONS FOR GLENDALE FIRE STATION
SECTION 07901 - JOINT SEALANTS

3. Latex Sealant Installation Standard: Comply with requirements of ASTM C 90 for use of latex sealants.
 4. Acoustical Sealant Application Standard: Comply with recommendations of ASTM C 19 for use of joint sealants in acoustical applications as applicable to materials, applications, and conditions indicated.
 5. Installation of Sealant Backings: Install sealant backings to comply with the following requirements:
 1. Install joint fillers of type indicated to provide support of sealants during application and at position required to produce the cross-sectional shapes and depths of installed sealants relative to joint widths that allow optimum sealant movement capability.
 - a. Do not leave gaps between ends of joint fillers.
 - b. Do not stretch, twist, puncture, or tear joint fillers.
 - c. Remove absorbent joint fillers that have become wet prior to sealant application and replace with dry material.
 - d. Install bond breaker - tape between sealants where backer rods are not used between sealants and joint fillers or back of joints.
- B. Installation of Sealants: Install sealants by proven techniques that result in sealants directly contacting and fully wetting joint substrates, completely filling recesses provided for each joint configuration, and providing uniform, cross-sectional shapes and depths relative to joint widths that allow optimum sealant movement capability. Install sealants at the same time sealant backings are installed.
- C. Tooling of Nonsag Sealants: Immediately after sealant application and prior to time skinning or curing begins, tool sealants to form smooth, uniform beads of configuration indicated, to eliminate air pockets, and to ensure contact and adhesion of sealant with sides of joint. Remove excess sealants from surfaces adjacent to joint. Do not use tooling agents that discolor sealants or adjacent surfaces or are not approved by sealant manufacturer.
1. Provide concave joint configuration per Figure 5A in ASTM C 62, unless otherwise indicated.
 2. Provide flush joint configuration, per Figure 58 in ASTM C 962, where indicated. Use masking tape to protect adjacent surfaces of recessed tooled joints.
- D. Provide recessed joint configuration, per Figure 5C in ASTM C 962, of recess, depth and at locations indicated.

TECHNICAL SPECIFICATIONS FOR GLENDALE FIRE STATION
SECTION 07901 - JOINT SEALANTS

- E. Installation of Preformed Foam Sealants: Install each length of sealant immediately after removing protective wrapping, taking care not to pull or stretch material, and to comply with sealant manufacturer's directions for installation methods, materials, and tools that produce seal continuity at ends, turns, and intersections of joints. For applications at low ambient temperatures where, expansion of sealant requires acceleration to produce seal, apply heat to sealant in conformance with sealant manufacturer's recommendations.

3.4 CLEANING

- A. Clean off excess sealants or sealant smears adjacent to joints as work progresses by methods and with cleaning materials approved by manufacturers of joint sealants and of products in which joints occur.

3.5 PROTECTION

- A. Protect joint sealants during and after curing period from contact with contaminating substances or from damage resulting from construction operations or other causes so that they are without deterioration or damage at time of Substantial Completion. If, despite such protection, damage or deterioration occurs, cut out and remove damaged or deteriorated joint sealants immediately so that and installations with repaired areas are indistinguishable from original work.

END OF SECTION 07901

TECHNICAL SPECIFICATIONS FOR GLENDALE FIRE STATION
SECTION 07910 - JOINT FIRESTOPPING

PART 1 - GENERAL

1.1 RELATED DOCUMENTS

- A. Drawings and general provision of the Contract, including General and Supplementary Conditions and Division 01 Specification Sections, apply to this section.

1.2 SUMMARY

- A. Provide asbestos free joint firestopping including accessories for a complete system as indicated and specified.
- B. Section Includes:
1. Fire-resistive joint systems in and between fire-resistance-rated construction assemblies for the following:
 - a. Floor-to-floor joints.
 - b. Floor-to-wall joints.
 - c. Head-of-wall joints.
 - d. Wall-to-wall joints.
 - e. Other joints as indicated.
 2. Joints in smoke barriers and smoke partition systems.
 3. Perimeter fire-resistive joint systems consisting of floor-to-wall joints between perimeter edge of fire-resistance-rated floor assemblies and exterior curtain walls
- C. Related Sections include the following:
1. Division 7 Sections "Penetration Firestopping" for systems installed in openings in walls and floors with and without penetrating items.

1.3 REFERENCES

- A. Comply with current edition of referenced standards unless indicated otherwise.
- B. American National Standards Institute (ANSI):
1. ANSI/UL 263 – Fire tests of Building Construction and Materials.
 2. ANSI/UL 723 – Surface Burning Characteristics of Building Materials.
 3. ANSI/UL 2079 – Tests for Fire Resistance of Building Joint Systems.
- C. ASTM International (ASTM):
1. ASTM E 84 – Standard Test Method for Surface Burning Characteristics of Building Materials.

TECHNICAL SPECIFICATIONS FOR GLENDALE FIRE STATION
SECTION 07910 - JOINT FIRESTOPPING

2. ASTM E 119 – Standard Test Method for Fire Tests of Building Construction and Materials.
 3. ASTM E 1399 - Standard Test Method for Cyclic Movement and Measuring the Minimum and Maximum Joint Widths of Architectural Joint Systems.
 4. ASTM E 1966 - Standard Test Method for Fire Resistive Joint Systems.
 5. ASTM E 2307 - Fire Tests of Perimeter Fire Barrier Systems Using Intermediate Scale, Multi-Story Test Apparatus.
 6. ASTM E 2393 - Standard Practice for On-Site Inspection of Installed Fire Resistive Joint Systems and Perimeter Fire Barriers.
- D. Factory Mutual (FM) - FM4991 - Standard for Approval of Firestop Contractors.
- E. International Code Council (ICC):
1. International Building Code (IBC).
 2. International Residential Code (IRC).
- F. National Fire Protection Association (NFPA):
1. NFPA 70 - National Electrical Code.
 2. NFPA 101 - Life Safety Code.
 3. NFPA 5000 – Building Construction and Safety Code.
- G. Underwriters Laboratories (UL) - UL Building Materials Directory:
1. Joint Systems (XHBN).
 2. Forming Materials (XHKU).
 3. Fill, Void or Cavity Materials (XHHW).
- H. American Society of Sanitary Engineering (ASSE):
- I. ASSE Series 9000 – Professional Qualification Standard for Firestop Systems and Device Installers, Inspectors and Surveyors.
- J. International Association of Plumbing and Mechanical Officials (IAPMO):
1. Uniform Plumbing Code (UPC).
 2. Uniform Mechanical Code (UMC).
- K. International Standards Organization (ISO):
1. ISO 10295-2: 2009.
- 1.4 DEFINITIONS
- A. Firestopping: The use of material or combination of materials in a fire-rated wall or floor where it has been breached, so as to restore the integrity of the fire rated assembly.

TECHNICAL SPECIFICATIONS FOR GLENDALE FIRE STATION
SECTION 07910 - JOINT FIRESTOPPING

- B. System: The use of a specific firestop material of materials in conjunction with a specific wall or floor construction assembly and a specific gap condition, constitutes a system.

1.5 PERFORMANCE REQUIREMENTS

- A. General: For joints in the following construction, provide firestop joint systems that are produced and installed to resist spread of fire according to requirements indicated, resist passage of smoke and other gases, and maintain original fire-resistance rating of assembly in which firestop joint systems are installed:
 - 1. Fire-resistance-rated non-load-bearing walls, including partitions, with fire-protection-rated openings.
 - 2. Fire-resistance-rated floor assemblies.
 - 3. Exterior curtain-wall assemblies and fire-resistance-rated floor assemblies.
- B. Fire-Resistance Ratings of Joint Systems: Assembly ratings and movement capabilities indicated, but with assembly ratings not less than that equaling or exceeding fire-resistance rating of constructions in which joints are located, as determined by UL 2079.
- C. Provide systems that are listed by at least one of the following:
 - 1. Underwriters Laboratories Inc. (UL), in “Fire Resistance Directory”
 - 2. Intertek Testing Services (ITS) (includes agency formerly know as Omega Point Laboratories), in “Directory of Listed Products”
 - 3. Any other qualified independent testing and inspection agency that conducts periodic follow-up inspections and is acceptable to Authorities Having Jurisdiction (AHJ).
- D. Provide products identical to those tested and listed for classification by UL, ITS or any other qualified independent testing agency.
- E. Provide fire-resistive sealants and sprays for construction joints applications that are flexible enough to satisfy the movement criteria per the test standards ASTM E 1399, ASTM E-1966 or ANSI/UL 2079.
- F. Provide products that bear classification marking of qualified independent testing agency.
- G. Use only products specifically listed for use in listed systems.
- H. Provide products that meet the intent of the state or local and LEED® guidelines on volatile organic compounds (VOC).
- I. Provide products with the appropriate flame spread index and smoke develop index, when tested in accordance with ASTM E-84.

TECHNICAL SPECIFICATIONS FOR GLENDALE FIRE STATION
SECTION 07910 - JOINT FIRESTOPPING

- J. Firestopping materials must meet and be acceptable for use by all building codes and NFPA codes.
- K. Provide products that are compatible with each other, with the substrates forming openings, and with the items, if any, penetrating the fire-resistive system, under the conditions represented by this project, based on testing and field performance demonstrated by manufacturer.
- L. Ratings of Perimeter Fire-Resistive Joint Systems: As indicated, determined by NFPA 285 and UL 2079.

1.6 SUBMITTALS

- A. Submit under provisions of the Contract and Division 01 – General Requirements.
- B. Shop Drawings: For each through-penetration firestop system, show each type of construction penetrated, relationships to adjoining construction and type of penetrating item. Include firestop design designation of qualified testing and inspecting agency that evidences compliance with requirements for each condition indicated.
 - 1. An applicable listing agency's detailed drawing showing opening, penetrating item(s) and firestopping materials; identified by listing agency's name, number or designation and fire rating achieved.
 - 2. Where project conditions require modification to a listing, submit listing agency's drawing marked to show modifications and approved by firestop system manufacturer.
- C. Product Certificates: Submit certificates of conformance signed by firestop system manufacturer certifying that materials furnished comply with requirements.
- D. Product Data Sheets: Furnish firestop system manufacturer's product data sheets on each material to be used in firestop systems. Information on manufacturer's product data sheet should include:
 - 1. Product characteristics including compliance with appropriate ANSI/UL/ASTM testing standards.
 - 2. Storage and handling requirements and recommendations.
- E. Installation Instructions: Furnish firestop system manufacturer's installation instructions.
- F. Sustainable or LEED Submittals:
 - 1. VOC Content: For fire-resistance joint and gap systems, furnish documentation of VOC content.
- G. Qualification Data: For Installer.

TECHNICAL SPECIFICATIONS FOR GLENDALE FIRE STATION
SECTION 07910 - JOINT FIRESTOPPING

1.7 QUALITY ASSURANCE

- A. Fire-Test-Response Characteristics: Tested by UL, ITS-WHi or other approved testing agency.
- B. General: All joint firestop systems shall be installed with approved methods using material that have been tested and classified to produce an approved assembly.
- C. Installer Qualifications: A firm experienced in installing joint firestop systems similar material(s), design(s) and extent to that indicated for this Project, whose work has resulted in construction with a record of successful performance.
- D. Installation Responsibility: Assign installation of all joint firestop systems in Project to a single qualified installer.
- E. Source Limitations: Obtain joint firestop systems, for each kind of joint and conditions indicated, through one source from a single firestop system manufacturer.
- F. Codes: Where a firestop systems manufacturer's application procedures are in conflict with those of the code authority having jurisdiction (AHJ), the more strict guidelines will prevail.
- G. Pre-installation Conference: Conduct conference at Project site to agree on firestop requirements, conditions, and firestop system manufacturer's instructions.
 - 1. Coordinate construction so that the joint firestop system may be installed in accordance with its listing.
 - 2. Do not cover-up joint firestop system installations that become concealed behind other construction until each installation has been examined by inspecting agency, building inspector, if required by authorities having jurisdiction.

1.8 DELIVERY, STORAGE AND HANDLING

- A. Deliver and store joint firestop system products to Project site in original, unopened packaging with intact and legible manufacturer's labels and identifying product and manufacturer, date of manufacture, lot number, shelf life, listing agency's classification marking, curing time and mixing instruction if applicable.
- B. Store and handle materials for joint firestop systems to prevent their deterioration or damage due to moisture, temperature changes, contaminants or other causes; follow manufacturer's instructions.
- C. Store and dispose of hazardous material, and material contaminated by hazardous materials, in accordance with requirements of local authorities having jurisdiction (AHJ).

TECHNICAL SPECIFICATIONS FOR GLENDALE FIRE STATION
SECTION 07910 - JOINT FIRESTOPPING

1.9 PROJECT CONDITIONS

- A. Environmental Limitations: Do not install joint firestop systems when ambient or substrate temperatures are outside limits permitted by firestop system manufacturer or when substrates are wet due to rain, frost, condensation, or other causes.
- B. Ventilation: Provide ventilation as per firestop systems manufacturer's instructions; by natural means, or where this is inadequate, by forced-air circulation.
- C. Maintain environmental conditions (ventilation, humidity and temperature) within limits recommended by the firestop manufacturer. Do not install the firestopping when the environmental conditions recommended are not met.

1.10 WARRANTY

- A. Provide a copy of the firestop manufacturer's standard limit warranty against manufacturing defects, terms, conditions and exclusion from coverage.

PART 2 - PRODUCTS

2.1 MANUFACTURERS

- A. Products: Subject to compliance with requirements, manufacturers offering products that may be incorporated in the Project include, but are not limited to the following;
 - 1. Passive Fire Protection (PFP) Partners, Delta, BC V3M 6T8 Toll Free: 800.810.1788 email: firestop@firestop.com website: www.firestop.com
- B. Substitutions: Requests for substitutions will be considered in accordance with Section 01 60 00.
- C. Single Source: To maintain control and integrity of the firestop applications a single firestopping manufacturer should be used. Specific UL, ITS and or other approved listing agencies systems applicable to each type of firestop condition should be supplied by one firestopping manufacturer.

2.2 SCOPE/APPLICATION

- A. Provide installed fire-resistive products that limit the spread of fire, heat, smoke, and gasses through otherwise unprotected openings in rated assemblies, including walls, partitions, floors, roof/ceilings, and similar locations, restoring the integrity of the fire-rated construction to its original fire rating.

TECHNICAL SPECIFICATIONS FOR GLENDALE FIRE STATION
SECTION 07910 - JOINT FIRESTOPPING

- B. Provide fire-resistive systems listed for construction gaps per the specific combination of fire-rated construction type, configuration, gap dimensions, and fire rating, and the following criteria:
 - 1. Fire-resistance rating must be equal to or greater than that of the assembly in which it is to be installed.
 - 2. Movement capability must be appropriate to the potential movement of the gap, demonstrated by testing in accordance with ASTM E 1399 for minimum of 500 cycles at 10 cycles per minute.
 - 3. Determine ratings in accordance with UL 2079.

2.3 THROUGH PENETRATION FIRESTOP SYSTEMS

- A. PFP Partners 3500SI Mastic: One component, low VOC, water-based latex, intumescent spray.
- B. PFP Partners 3600EX Sealant: One component, low VOC, intumescent, water based, acrylic latex sealant
- C. PFP Partners 4100SL Sealant: One component, low VOC, water-based latex, self-leveling for floor openings.
- D. PFP Partners 4100NS Sealant: One component, low VOC, water-based latex, non-sag sealant for floor and wall openings.
- E. PFP Partners 4800DW Sealant: One component, low VOC, water-based latex, low sag, paintable sealant.
- F. PFP Partners 5100SP Mastic: One component, low VOC, water-based latex, endothermic spray.

PART 3 - EXECUTION

3.1 EXAMINATION

- A. Before beginning installation, verify that substrate conditions previously installed under other sections are acceptable for installation of firestopping in accordance with manufacturer's installation instructions and technical bulletins.
 - 1. Proceed with installation only after unsatisfactory conditions have been corrected.

TECHNICAL SPECIFICATIONS FOR GLENDALE FIRE STATION
SECTION 07910 - JOINT FIRESTOPPING

3.2 PREPARATION

- A. Surface Cleaning: All surfaces shall be free of foreign materials (dirt, grease, oil, scale, rust, releasing agents, water repellents) and any other substances that could interfere with the adhesion of the joint firestop systems.
- B. Provide masking and temporary covering to protect adjacent surfaces, when required. Remove tape as soon as possible without disturbing

3.3 JOINT FIRESTOP SYSTEM INSTALLATION

- A. General: Install joint firestop systems to comply with Part 1 "Performance Requirements" Article and with firestop system manufacturer's written installation instructions and published drawings for product and application indicated.
- B. Installation Instructions: Comply with (UL), (ITS) or and or other approved listing agencies Listings and joint firestop manufacturer's instructions for installation of firestopping products and the following:
 - 1. Install so that all openings or voids are completely filled and material is securely adhered.
 - 2. Where joint firestop materials are exposed to view, finish to a smooth, uniform surface.
 - 3. Repair or replace defective installations in accordance with manufacturer's recommendations and listed system details to comply with requirements.
 - 4. Protect materials from damage on surfaces subjected to traffic.
 - 5. Apply materials so they contact and adhere to substrates formed by openings.

3.4 IDENTIFICATION

- A. Identify through-penetration firestop systems with preprinted metal or plastic labels. Attach labels permanently to surfaces adjacent to and within 6 inches of edge of the firestop systems so that labels will be visible to anyone seeking to remove joint firestop systems. Use mechanical fasteners for metal labels. For plastic labels, use self-adhering type with adhesives capable of permanently bonding labels to surfaces on which labels are placed and, in combination with label material, will result in partial destruction of label if removal is attempted. Include the following information on labels:
 - 1. The words "Warning – Construction Gap Fire Resistive System - Do Not Disturb. Notify Building Management of Any Damage."
 - 2. Contractor's name, address, and phone number.
 - 3. Joint firestop system designation of applicable testing and inspecting agency.
 - 4. Date of installation.
 - 5. Joint firestop system manufacturer's name.
 - 6. Installer's name.

TECHNICAL SPECIFICATIONS FOR GLENDALE FIRE STATION

SECTION 07910 - JOINT FIRESTOPPING

3.5 REPAIRS AND MODIFICATIONS

- A. Identify damage or re-entered seals requiring repair or modification
- B. Remove loose or damaged materials
- C. If penetrating item(s) are to be added, remove sufficient material to insert new elements. Care must be used not to cause damage to the balance of the seal.
- D. Insure that surfaces to be sealed are clean and dry.
- E. Install materials in accordance with Paragraph 3.3 as required. Use only materials approved by through-penetration firestop manufacturer as suitable for repair of original seal. Never mix different manufacturer's firestopping materials.

3.6 FIELD QUALITY CONTROL

- A. Notify Consultant when completed installations are ready for inspection prior to concealing or enclosing an area containing firestopping materials.
- B. Arrange for inspection by the Owners independent inspection and testing company appointed and paid by Owner.
- C. Following field inspections, where deficiencies are found, all repairs or replacements as required to ensure compliance with the Contract Documents.

3.7 CLEANING AND PROTECTION

- A. Clean off excess material adjacent to openings as Project progresses by methods and with cleaning materials that are approved in writing by joint firestop system manufacturers and that do not damage materials in which openings occur.
- B. Provide final protection and maintain conditions during and after installation that ensure that joint firestop systems are without damage or deterioration at time of Substantial Completion. If, despite such protection, damage or deterioration occurs, cut out and remove damaged or deteriorated joint firestop systems immediately and install new material to produce systems complying with specified requirements.

END OF SECTION 07910

TECHNICAL SPECIFICATIONS FOR GLENDALE FIRE STATION
SECTION 07920 - PENETRATION FIRESTOPPING

PART 1 - GENERAL

1.1 SUMMARY

A. Related Documents:

1. Drawings and general provisions of the Subcontract apply to this Section.
2. Review these documents for coordination with additional requirements and information that apply to work under this Section.

B. Section Includes:

1. Firestops for sealing penetrations through fire rated floors and walls.
2. standards and specifications for firestopping work.
3. Firestop work shall conform to the requirements of this Section, but is a part of the section covering the actual penetration.

C. Products Supplied but Not Installed under This Section:

1. Division 05 Section "Metals": Installation of safing insulation in fire rated, sound isolation and airtight metal support assemblies.

D. Related Sections:

1. Division 01 Section "General Requirements."
2. Division 01 Section "Special Procedures."
3. Division 07 Section "Joint Firestopping".
4. Division 07 Section "Building Insulation".
5. Division 07 Section "Joint Sealants".
6. Drawings for coordination with fire suppression, plumbing, HVAC and electrical work.

1.2 REFERENCES

A. General:

1. The following documents form part of the Specifications to the extent stated. Where differences exist between codes and standards, the one affording the greatest protection shall apply.
2. Unless otherwise noted, the referenced standard edition is the current one at the time of commencement of the Work.
3. Refer to Division 01 Section "General Requirements" for the list of applicable regulatory requirements.

B. ASTM International:

1. ASTM E84 - Standard Test Method for Surface Burning Characteristics of Building Materials

TECHNICAL SPECIFICATIONS FOR GLENDALE FIRE STATION
SECTION 07920 - PENETRATION FIRESTOPPING

2. ASTM E119 - Standard Test Methods for Fire Tests of Building Construction and Materials
 3. ASTM E814 - Standard Test Method for Fire Tests of Penetration Firestop Systems
- C. BAAQMD Regulation 8-51 - Adhesive and Sealant Products.
- D. FBC – Florida Building Code.
- E. Federal Specification HH-I-521F - Insulation Blankets, Thermal (Mineral Fiber, for Ambient Temperature).
- F. NEC - Nation Electrical Code.
- G. H. NFPA 70.
- H. UL Fire Resistance Directory.
1. UL 1479 - Fire Tests of Through-Penetration Firestops.

1.3 SYSTEM DESCRIPTION

- A. Specified firestopping systems are based on a solid sealant only, or combinations of solid sealant, foam sealant, and refractory fibers of thickness required to attain hour ratings.
- B. Systems shall:
1. Provide a flexible seal to prevent passage of fire, smoke, toxic gases and water through openings, and prevent transmission of sound and vibration from the penetrating element to the structure.
 2. Provide hour ratings indicated and in accordance with ASTM E 814 or UL 1479.
 3. Comply with requirements of CBC Sections 709.6, 709.7, 709.8, 710.2, 710.3 and 710.6, and CBC Standards 7-1 and 7-5.

1.4 SUBMITTALS

- A. Submit under provisions of Division 01 Section "General Requirements."
- B. Product Data: Manufacturer's specifications, product data, material safety data sheets, and installation instructions for each type of installation required, listing specific materials proposed.
- C. Shop Drawings: Manufacturer's detail drawings and applicable UL system numbers for firestop systems to be installed.
- D. Samples: Samples of each item when requested by Project Manager.

TECHNICAL SPECIFICATIONS FOR GLENDALE FIRE STATION
SECTION 07920 - PENETRATION FIRESTOPPING

- E. Manufacturer's Recommendations: Manufacturer's written recommendations for installations or configurations not covered by a UL-listed firestop system.
- F. Test Reports: Manufacturer's published test reports. Include manufacturer's system number and UL listing for each type of penetration.
- G. Certification: Manufacturer's written certification that firestopping system(s) furnished comply with UL system requirements, are approved for each specific condition of use on the Project.
- H. Closeout Submittals:
 - 1. Sealant and adhesive quantity use in accordance with requirements of BAAQMD Regulation 8-51.
 - 2. Written guarantee.

1.5 QUALITY ASSURANCE

- A. Firestopping systems shall be the products of one manufacturer Coordinate the work of the trades toward achieving this end.
- B. Installer Qualifications: Firm experienced in installation or application of systems similar in complexity to those required by this Project, and acceptable to or licensed by the product manufacturer.
- C. Regulatory Requirements:
 - 1. Comply with the requirements of Bay Area Air Quality Management District Regulation 8-51.
 - 2. Products shall be 100% asbestos and PCB free.

DELIVERY, STORAGE AND HANDLING

- D. Deliver firestopping materials to job site in factory sealed, unopened containers bearing manufacturer's name, brand, product designation, batch number and packaging date.
- E. Store in unopened containers. Follow manufacturer's recommendations for storage temperatures and shelf life.
- F. Follow manufacturer's recommendations for handling products containing toxic materials. Use recommended solvents and cleaning agents for cleaning tools, equipment and skin.

1.6 PROJECT CONDITIONS

- A. Environmental Requirements:

TECHNICAL SPECIFICATIONS FOR GLENDALE FIRE STATION
SECTION 07920 - PENETRATION FIRESTOPPING

1. Furnish adequate ventilation if using solvent.
2. Furnish forced air ventilation during installation if required by manufacturer.
3. Keep flammable materials away from sparks or flame.
4. Provide masking and drop cloths to prevent contamination of adjacent surfaces by firestopping materials.
5. Comply with manufacturer's recommendations for temperature and humidity conditions before, during and after installation of firestopping.

- B. Existing Conditions: Verify existing conditions and substrates before starting work. Correct unsatisfactory conditions before proceeding. Proceed with installation only after penetrations of substrates have been completed and supporting brackets installed.

1.7 guarantee

- A. Written guarantee agreeing to repair or replace firestopping which fails in joint adhesion, co-adhesion, abrasion resistance, weather resistance, extrusion resistance, migration resistance, stain resistance, or general durability, or appears to deteriorate in any other manner not clearly specified by submitted manufacturer's data as an inherent quality of the material for the exposure indicated.

PART 2 - PRODUCTS

2.1 MANUFACTURERS

- A. Manufacturers: 3M, Hilti, Nelson, or as otherwise specified.
- B. Established Standard: Unless otherwise specified, 3M products are specified to establish standards and type of materials required. Equal products of manufacturers specified above are acceptable.

2.2 MATERIALS

- A. Sealant: Select among the following materials as appropriate.
1. Solid (Elastomeric): 3M Fire Barrier Premium Latex CP 25WB+ Caulk, one-component elastomeric water-based latex sealant designed for use as a through-penetration firestop.
 2. Foam: 3M Fire Barrier 2001 Silicone RTV Foam, two-component silicone elastomer foam-in-place sealant designed to fill irregular or complex voids.
 3. Wrap Strip: 3M Fire Barrier FS-195+ Wrap Strip, fire resistive strip designed to be wrapped around the penetrating item and secured in place.
 4. Restricting Collar: 3M Fire Barrier RC-1 Restricting Collar, sheet metal, designed for use with wrap strip in combustible through-wall firestop penetration systems.

TECHNICAL SPECIFICATIONS FOR GLENDALE FIRE STATION
SECTION 07920 - PENETRATION FIRESTOPPING

5. Composite Sheet: 3M Fire Barrier CS-195+ Composite Sheet, elastomeric layer reinforced with mesh restraining wire and covered with aluminum foil on one side and bonded to sheet metal, forming a fire resistive sheet.
 6. Putty: 3M Fire Barrier MP Moldable Putty+ Pads and Sticks, one-component elastomeric formable putty, designed for use as a through-penetration firestop system.
 7. Spray: 3M FireDam Spray 100, flexible water-based coating.
 8. Primers: As recommended by sealant manufacturer.
- B. B. Pillows: Nelson PLW Firestop Pillow, Hilti FS Fire Block, dust proof chemical resistant cloth with heat-reactive expanding solidifying fill, designed for large openings that require frequent cable alterations.
- C. Safing Insulation: USG "Thermafiber Safing Insulation", 4 lb density mineral wool insulation unless indicated otherwise.
- D. D. Damming Materials: As recommended by firestop manufacturer.

PART 3 - EXECUTION

3.1 CONDITION OF SURFACES

- A. Inspect surfaces to receive firestopping materials and report any defects to Project Manager. Do not start work until defects have been corrected. Starting work implies acceptance of surfaces as satisfactory.
- B. Unless otherwise permitted by manufacturer, do not apply firestopping materials to polycarbonates; materials that bleed oils, plasticizers or solvents; organo-metallic compounds; silicone rubber containing organo-tin compound; sulfur, polysulfides, polysulfones and other sulfur containing materials; amines, urethanes and amine-containing materials; and unsaturated hydrocarbon plasticizers.
- C. Do not apply materials in confined spaces where material is not exposed to atmospheric moisture.

3.2 PREPARATION

- A. Thoroughly clean surfaces and spaces to receive firestopping materials, removing foreign matter such as dirt, dust, moisture, rust, laitance, mill scale, oil, paint, lacquer, form coatings, water repellents and protective coatings.
- B. Do not use cleaning solvents which leave residue. Wipe joints free of solvent using clean, dry white cloths or white lintless paper. Do not use alcohol or alcohol based

TECHNICAL SPECIFICATIONS FOR GLENDALE FIRE STATION
SECTION 07920 - PENETRATION FIRESTOPPING

materials. Do not permit solvent to air dry. Do not use detergents or soap and water solutions for cleaning unless specifically recommended by the sealant manufacturer.

- C. Follow manufacturer's directions for specific products and surfaces.

3.3 MIXING

- A. Job mix foam sealants in accordance with manufacturer's directions using approved equipment.
- B. Stir separate parts of multi-component sealants until settled fillers and pigments and any surface liquid are thoroughly dispersed.
- C. Combine separate parts in accordance with mixing instructions.

3.4 INSTALLATION

- A. Install systems in accordance with UL systems, and manufacturer's specifications and recommendations, using approved equipment and so as to achieve the required fire rating.
- B. Surface Preparation: Prepare surfaces as recommended by manufacturer immediately prior to installation of firestopping materials. If primers are used, make preliminary tests to ensure that primers will not stain exposed materials.
- C. Masking: Mask surrounding areas where necessary to prevent stains on exposed finished surfaces. Do not apply masking to surfaces which are to receive sealant materials. Remove masking immediately following completion of sealant work.
- D. Damming: Form leakproof dams as required to seal openings and contain sealant materials until cure is complete. Follow sealant manufacturer's recommendations.
- E. Sealing:
 - 1. Solid Sealant: For small spaces and where exposed to view in wall face. Immediately tool completed seal to slightly concave surface using recommended tooling agent.
 - 2. Foam:
 - a. Use automatic metering, mixing, and dispensing equipment for large volume applications; factory prepared cartridges may be used for small volumes.
 - b. In general, use foam sealant for all applications except where solid sealant is permitted.
 - c. When sealant has cured, neatly trim excess where exposed to view.

TECHNICAL SPECIFICATIONS FOR GLENDALE FIRE STATION
SECTION 07920 - PENETRATION FIRESTOPPING

3. Spray: Install in accordance with manufacturer's recommendations and requirements for specific use.

3.5 FIELD QUALITY CONTROL

- A. Perform manufacturer's quality control check program at least once daily and upon changing to new lot of materials.
- B. Inspect cured seals after 24 hours by removing damming materials to examine seals. Replace dams where a required part of assembly.
- C. Where voids occur, fill with freshly mixed foam or solid sealant. Reinspect after added material has cured 24 hours.
- D. Ensure that cured foam sealants show acceptable or better color and cell structure range per manufacturer's recommendations.
- E. Remove unacceptable sealants and replace with new.

3.6 CLEANING

- A. Clean adjacent surfaces soiled by firestopping work.

3.7 SCHEDULE

| | Location | Fire Rating |
|----|----------------------------|-------------|
| A. | Occupancy Separation Walls | 2 hour |
| B. | Area Separation Walls | 2 hour |

END OF SECTION 07920

TECHNICAL SPECIFICATIONS FOR GLENDALE FIRE STATION
SECTION 07930 WATER REPELLENTS

PART 1 GENERAL

1.1 SECTION INCLUDES

- A. Water repellents of the following types from Okon and Seal-Krete:
 - 1. Penetrating water repellents.
 - 2. Film-building water repellents.
 - 3. Breathable color-added coatings.

- B. Water repellents for the following types of surfaces:
 - 1. Above-grade.
 - 2. Vertical and horizontal.
 - 3. Concrete and masonry.
 - 4. Porous and textured masonry.
 - 5. Portland cement plaster and stucco.
 - 6. Clay and concrete Brick
 - 7. Natural and cast stone.
 - 8. Tile, canvas, wood and similar items.

1.2 RELATED SECTIONS

- A. Section 03300 - Cast-in-Place Concrete.
- B. Section 04810 - Unit Masonry.
- C. Section 09651- Tile Flooring.

1.3 REFERENCES

- A. ASTM International, Inc. (ASTM):
 - 1. ASTM D 2887 - Standard Test Method for Boiling Range Distribution of Petroleum Fractions by Gas Chromatography.
 - 2. ASTM D 1653 - Standard Test Methods for Water Vapor Transmission of Organic Coating Films.
 - 3. ASTM D 3359 - Standard Test Methods for Measuring Adhesion by Tape Test.
 - 4. ASTM E 96 - Standard Test Methods for Water Vapor Transmission of Materials.
 - 5. ASTM E 514 - Standard Test Method for Water Penetration and Leakage Through Masonry,

- B. South Coast Air Quality Management District (SCAQMD).

- C. Federal Specification (FS) SS-W-110C - Water-Repellent, Colorless, Silicone Resin Base.

1.4 SUBMITTALS

- A. Submit under provisions of Section 01 30 00 - Administrative Requirements.

- B. Product Data: For each coating system indicated, including:
 - 1. Material List: An inclusive list of required coating materials. Indicate each material and cross-reference specific coating, finish system, and application. Identify each material by manufacturer's catalog number and general classification.
 - 2. Preparation instructions and recommendations.
 - 3. Manufacturer's Information: Manufacturer's technical data bulletin and MSDS, including label analysis and instructions for handling, storing, and applying each coating material.

- C. Third-party report confirming that recommended system has been tested in accordance with

TECHNICAL SPECIFICATIONS FOR GLENDALE FIRE STATION

SECTION 07930 WATER REPELLENTS

ASTM E 514 on similar CMU substrate and reduced water absorption by a minimum of 90 percent in comparison to untreated specimen.

- D. Certification by water repellent manufacturer that's products supplied comply with local regulations controlling VOC emissions.
- E. Selection Samples: For colored finishes, submit color sample - Samples of each color applied to substrate used on project must be submitted to architect for approval. Architects may use paint color swatches to direct color choices but must be shown samples of each color applied to substrates to illustrate influence of substrate color and variation in transparency between colors. A second coat of stain may be applied and will significantly increase the color saturation of the stain. The architect shall pre-approve in writing a second application of stain before it is applied.

1.5 QUALITY ASSURANCE

- A. Manufacturer Qualifications: Capable of providing field service representation during installation and who will approve application method.
- B. Installer Qualifications: Installer experienced in performing this type of work and who has specialized in work similar to the type required for this project.
- C. Field Sample:
 - 1. Install at Project site or pre-selected area of building an area for field sample, as directed by Architect.
 - 2. Provide mockup of at least 100 square feet (9.3 sq. m) to include surface preparation, sealant joint, and juncture details and allow for evaluation of concrete stain top coated with specified water repellent.
 - 3. Conduct a minimum of three RILEM tests before and after the water repellent has been applied. Allow sealer to cure three days before completing the post-application test. At least one RILEM test should be performed on a mortar joint within the test area. The average water loss should never exceed 1 ml in 3 minutes or be less than 90 percent improvement when compared to test conducted prior to application of the stain.
 - 4. Apply material in strict accordance with manufacturer's written application instructions.
 - 5. Obtain Architect's written approval of field sample before start of material application, including approval of aesthetics, color, texture, and appearance.
 - 6. Manufacturer's representative will review surface preparation, application, and workmanship.
 - 7. Field sample will be the standard for judging workmanship on remainder of Project.
 - 8. Field sample shall be maintained during construction for workmanship comparison.
 - 9. Field sample shall not be altered, moved, or destroyed until Work is completed and approved by Architect.
 - 10. Intermix enough product at one time to cover areas between architectural breaks. See manufacturer's technical data bulletin for application instructions.

1.6 DELIVERY, STORAGE, AND HANDLING

- A. Deliver materials to Project site in manufacturer's original, unopened packages and containers bearing manufacturer's name and label:
- B. Storage: Store and dispose of solvent-based materials, and materials used with solvent-based materials, in accordance with requirements of local authorities having jurisdiction.
- C. Store materials in an area that is within the acceptable temperature range, per manufacturer's instructions. Protect from freezing.

TECHNICAL SPECIFICATIONS FOR GLENDALE FIRE STATION

SECTION 07930 WATER REPELLENTS

- D. Handling: Maintain a clean, dry storage area, to prevent contamination or damage to the coatings.
- E. Store materials not in use in tightly covered containers in a well-ventilated area at a minimum ambient temperature of 35 deg F (2 deg C) and not above 100 deg F (43 C).
- F. Maintain storage containers in a clean condition, free of foreign materials and residue.

1.7 PROJECT CONDITIONS

- A. Maintain environmental conditions (temperature, humidity, and ventilation) within limits recommended by manufacturer for optimum results. Do not install products under environmental conditions outside manufacturer's absolute limits.
- B. Do not apply coatings in snow, rain, fog, or mist; or when relative humidity exceeds 85 percent; or at temperatures less than 5 deg F (3 deg C) above the dew point; or to damp or wet surfaces.
 - 1. Application may continue during inclement weather if surfaces and areas to be coated are enclosed and heated within temperature limits specified by manufacturer during application and drying periods.
- C. Weather and Substrate Conditions: Do not proceed with application of water repellent under any of the following conditions, except with written instructions from the manufacturer:
 - 1. Ambient air and surface temperature is less than 50 degrees F.
 - 2. Concrete surfaces and mortar have cured less than 28 days.
 - 3. Rain or temperatures below 50 degrees F are predicted within 24 hours.
 - 4. Do not apply coatings when rain is expected less than 12-24 hours after installation
 - 5. Application is earlier than 24 hours after surface has been wet.
 - 6. Substrate is frozen or surface temperature is less than 50 degrees F.
 - 7. Windy conditions exist that may cause water repellent to be blown onto surface not intended to be coated.

1.8 WARRANTY

- A. Perform work and submit manufacturer's required job registration and verification forms in accordance with Water Repellent Warranty Guidelines provided by Rust-Oleum. Provide manufacturer's 5-year Water Repellent Warranty.

1.9 EXTRA MATERIALS

- A. Furnish extra paint materials from the same production run as the materials applied and in the quantities described below. Package with protective covering for storage and identify with labels describing contents. Deliver extra materials to Owner.
- B. Quantity: Furnish Owner with an additional three percent, but not less than 1 gal (3.8 l) or 1 case, as appropriate, of each material and color applied.

PART 2 PRODUCTS

2.1 MANUFACTURERS

- A. Acceptable Manufacturer: Rust-Oleum®, which is located at: 11 Hawthorn Pkwy.; Vernon Hills, IL 60061; Toll Free Tel: 800-323-3584; Tel: 847-367-7700; Fax: 847-816-2330; Email:technicalservice@rustoleum.com; Web:<https://www.rustoleum.com>
- B. Specification and product questions should be directed to David O'Bryan at technicalservice@rustoleum.com.

TECHNICAL SPECIFICATIONS FOR GLENDALE FIRE STATION
SECTION 07930 WATER REPELLENTS

- C. Substitutions: Engineer approved equal.
 - D. Requests for substitutions will be considered in accordance with provisions of Section 01 30 00 - Administrative Requirements Submittals and 01600 Products
- 2.2 FILM-FORMING CLEAR WATER REPELLENT FOR CAST CONCRETE, UNGLAZED BRICK, CONCRETE FLOORS, STONE AND SIMILAR SURFACES
- A. Penetrating Barrier - OKON W-1 Water Repellent Sealer is a water-based, acrylic, micro-emulsion containing 5 percent solids minimum by weight with the following minimum performance properties:
 - 1. VOC compliant in SCAQMD: 75 g/L.
 - 2. Specific Gravity: 1.01.
 - 3. Breathable: Yes - ASTM D 1653.
 - 4. Viscosity: < 100 CPS.
 - 5. Paintable: Yes - ASTM D 3359.
 - 6. Flash Point: N/A.
 - 7. Weight Solids: 5 percent.
- 2.3 FILM-FORMING CLEAR WATER REPELLENT FOR SMOOTH CONCRETE BLOCK (NOT LIGHTWEIGHT, EXPOSED AGGREGATE, OR SAND-BLASTED CAST CONCRETE)
- A. Penetrating Barrier - OKON W-2 Water Repellent Sealer is a water-based, acrylic, micro-emulsion containing 10 percent solids minimum by weight with the following minimum performance properties:
 - 1. VOC compliant in SCAQMD: 70 g/L.
 - 2. ASTM E 514 Standard Test Method for Water Penetration and Leakage through Masonry tested on like substrate: > 90 percent reduction in water penetration compared to unsealed surface. Two coats may be required to achieve this level of performance on porous block.
 - 3. Specific Gravity: 1.01.
 - 4. Breathable: Yes - ASTM D 1653.
 - 5. Viscosity: < 100 CPS.
 - 6. Paintable: Yes - ASTM D 3359.
 - 7. Flash Point: N/A.
 - 8. Weight Solids: 10 percent.
- 2.4 FILM-FORMING CLEAR WATER REPELLENT FOR SPLIT-FACE, ROUGH AND POROUS CONCRETE BLOCK
- A. Penetrating Barrier - OKON Plugger Water Repellent Sealer is a water-based acrylic micro-emulsion containing 20 percent solids minimum by weight with the following minimum performance properties:
 - 1. VOC compliant in SCAQMD: 75 g/L.
 - 2. ASTM E 514 Standard Test Method for Water Penetration and Leakage through Masonry tested on like substrate: > 90 percent reduction in water penetration compared to unsealed surface. Two coats may be required to achieve this level of performance on porous block.
 - 3. Specific Gravity: 1.01.
 - 4. Breathable: Yes - ASTM D 1653.
 - 5. Paintable: Yes - ASTM D 3359.
 - 6. Flash Point: N/A.
 - 7. Weight Solids: 20 percent.
- 2.5 FILM-FORMING CLEAR WATER REPELLENT FOR FAIRLY POROUS CONCRETE AND UNPAINTED WOOD

TECHNICAL SPECIFICATIONS FOR GLENDALE FIRE STATION
SECTION 07930 WATER REPELLENTS

- A. Penetrating Barrier - OKON Multi-Surface Water Repellent Sealer is a water-based, acrylic micro-emulsion, siloxane blend containing a minimum 8 percent solids by weight with the following minimum performance properties:
1. VOC compliant in SCAQMD: 67 g/L.
 2. Specific Gravity: 1.01.
 3. Breathable: Yes - ASTM D 1653.
 4. Viscosity: < 100 CPS.
 5. Paintable: Yes - ASTM D 3359.
 6. Flash Point: N/A.
 7. Weight Solids: 8 percent.
- 2.6 NON-FILM FORMING WATER REPELLENT SEALER FOR DENSE CAST-CONCRETE, PRECAST CONCRETE, STUCCO, SANDSTONE, ADOBE, SLATE AND SIMILAR SURFACES
- A. Penetrating Sealer - OKON S-20 is a Silane/Siloxane, clear, water-base, odorless, non-yellowing, penetrating, non-film forming water repellent sealer with the following minimum performance properties:
1. VOC Compliant in SCAQMD: < 100 g/L.
 2. Depth of Penetration: >=3/8 inch (9.5 mm).
 3. Specific Gravity: 1.01
 4. Breathable: Yes - ASTM D 1653
 5. Viscosity: < 50 CPS.
 6. Paintable: Yes - ASTM D 3359
 7. Flash Point: > 200 degrees F (93 degrees C)
- 2.7 NON-FILM FORMING WATER REPELLENT SEALER FOR DENSE CAST-CONCRETE, PRECAST CONCRETE, STUCCO, SANDSTONE, ADOBE, SLATE AND SIMILAR SURFACES FOR GOVERNMENT SPECIFICATIONS AND HIGHWAY WORK (RESISTS SALT, CHEMICALS AND HOT TIRE PICKUP)
- A. Penetrating Sealers - OKON S-40 is an Oligomeric Silane/Siloxane, clear, water-based, odorless, non-yellowing, penetrating, non-film forming water repellent sealer with the following minimum performance properties:
1. VOC Compliant in SCAQMD: < 200 g/L.
 2. Depth of Penetration: >=3/8 inch (9.5 mm).
 3. Specific Gravity: 1.01.
 4. Breathable: Yes - ASTM D 1653.
 5. Viscosity: < 50 CPS.
 6. Paintable: Yes - ASTM D 3359.
 7. Flash Point: > 200 degrees F (93 degrees C).
 8. Resistance to UV: Excellent Accelerated weathering 1500 hours - No change.
 9. Abrasion Resistance: Excellent.
 10. Properties of the Oligomeric Silane/Siloxane Treated Concrete:
 - a. The water repellent shall have been evaluated in accordance with the National Cooperative Highway Research Program, Report No. 244.
 - 1) Reduction in Water Absorption: 80 percent.
 - 2) Water Vapor Transmission: 121 percent.
 - 3) Reduction in Chloride Ion Intrusion: 83 percent.
 - 4) Water Permeance (S-40. dilute 9:1): ASTM E 514: passes Mortar > 90 percent reduction in water penetration compared to unsealed surface; Brick - 100 percent reduction.
 - 5) The penetrating water repellent will not form a vapor barrier.
 - 6) The penetrating water repellent will not have film-forming capability.
 - 7) The penetrating water repellent will not change the color, appearance, or surface texture of the treated surface.
 - b. ASTM E 514 Standard Test Method for Water Penetration and Leakage

TECHNICAL SPECIFICATIONS FOR GLENDALE FIRE STATION
SECTION 07930 WATER REPELLENTS

- through Masonry tested on like substrate.
- c. Reduction in absorption - SS-W-110c \geq 88 percent.

2.8 MASONRY SEALER FOR HORIZONTAL SURFACES FOR CONCRETE FLOORS FOR RESISTANCE TO STAINING, LOW GLOSS FINISH

- A. Concrete and Masonry Sealer - OKON Seal & Finish Clear Concrete / Masonry Sealer is a water-based, acrylic, micro-emulsion coating containing 15 percent solids minimum by weight with the following minimum performance properties:
 - 1. VOC compliant in SCAQMD: 62 g/L.
 - 2. Specific Gravity: 1.01.
 - 3. Breathable: Yes - ASTM D 1653.
 - 4. Viscosity: < 100 CPS.
 - 5. Paintable: Yes - ASTM D 3359.
 - 6. Flash Point: N/A.
 - 7. Weight Solids: 15 percent.

2.9 SEAL-KRETE WATER REPELLENT SILANE SILOXANE SEALER FOR HORIZONTAL AND VERTICAL MASONRY SURFACES

- A. SEAL-KRETE SS-10
 - 1. VOC Compliant in SCAQMD: < 100 g/l.
 - 2. Weight Solids: 10%.
 - 3. Breathable: Yes - ASTM 1653.
 - 4. Flash Point: N/A.
- B. Waterproof Sealer: Seal-Krete Original Waterproofing Primer Sealer; a clear, non-staining, waterborne acrylic-base penetrating sealer primer containing low quantities of VOCs:
 - 1. Resistance to Water Penetration: Minimum rating of Excellent, when tested according to FS TT-P-0035, modified using 4 by 8 by 16 inch (100 by 200 by 400 mm) concrete block, at equivalent of 98 mph (158 km/h) wind speed.
 - 2. Resistance to Water Penetration: No more than 25 percent dampness appearing on back of wall specimen, when tested in accordance with ASTM E 514 for 4 hours.
 - 3. Water Vapor Transmission: 3.6 perms (207 ng/(Pa s sqm), maximum, when tested in accordance with ASTM D 1653.
 - 4. Corrosion Resistance: No visible degradation of film after 48 hours, when subjected to sodium hypochlorite, hydrochloric acid, sodium chloride (salt), and chlorine.
 - 5. Volume Solids: 10 percent, minimum.
 - 6. Flammability: Non-flammable.
 - 7. Toxicity: USDA approved for application to surfaces where there is possibility of contact with food.
 - 8. Tensile Strength: 1000 psi (6890 kPa).
 - 9. Freeze/Thaw Stability: 1 to 2 cycles.
 - 10. Fading Resistance: Approximately 0.05 percent, maximum, after 312 hours of testing.
 - 11. Comply with Florida Department of Transportation Specification 926-16 for Type "O" Compounds, Florida DOT Method FM5-518.
 - 12. Pigmenting Agent: Latex-based paint, specified in Section 09900.
 - 13. Pigmenting Agent: Latex-based stain, specified in Section 09900.
- C. Heavy Duty Waterproofer: Seal-Krete Heavy-Duty Concrete & Masonry Waterproofer; an advanced, high-solids, siliconized, acrylic blend designed to protect and strengthen bare, porous concrete and masonry, such as split-face or fluted concrete block. Provides a tough, breathable film that will not yellow.
 - 1. Resistance to Water Penetration: No more than 25 percent dampness appearing on back of wall specimen, when tested in accordance with ASTM E 514 for 4 hours.
 - 2. Solids Content: 25 percent minimum.

TECHNICAL SPECIFICATIONS FOR GLENDALE FIRE STATION
SECTION 07930 WATER REPELLENTS

3. Meets FS SS-W-110C for Water Repellency on Masonry.
4. Mildew Resistance: ASTM D 5590.
5. Flammability: Non-flammable.
6. Toxicity: USDA approved for application to surfaces where there is possibility of contact with food.

PART 3 EXECUTION

3.1 EXAMINATION

- A. Do not begin installation until substrates have been properly prepared.
- B. If substrate preparation is the responsibility of another installer, notify Architect of unsatisfactory preparation before proceeding.

3.2 PREPARATION

- A. Clean substrate of substances that might interfere with penetration or performance of water repellents. Remove all dust, dirt, paint, bitumen, efflorescence, oil, pollution deposits, and curing, forming, and parting compounds, other contaminants prior to application. Use abrasive brush blast or high pressure water as necessary to achieve the required surface condition.
- B. Allow power washed surfaces to dry three days prior to coating. Surface shall be dry to touch and show no visible signs of moisture prior to application of water repellent.
- C. Protect adjoining work, including sealant bond surfaces, from spillage or over spray of water repellent. Cover adjoining and nearby surfaces of aluminum and glass if there is the possibility of water repellent being deposited on surfaces.
- D. Coordination with Sealants: Do not apply water repellent until sealants for joints adjacent to surfaces receiving water repellent treatment have been installed and cured.
- E. Water repellent work may precede sealant application only if sealant adhesion and compatibility have been tested and verified using substrate, water repellent, and sealant materials identical to those used in the work.

3.3 APPLICATION

- A. Apply a heavy saturation spray coating of water repellent on surfaces indicated for treatment using pressure spray equipment. Comply with manufacturer's written instructions for using airless spraying procedure, unless otherwise directed.
- B. Follow application method and rate established by Test Area. Apply a second saturation spray coating, if required, repeating first application. Comply with manufacturer's written instructions for limitations on drying time between coats. Consult manufacturer's technical representative if written instructions are not applicable to project conditions.

3.4 FIELD QUALITY CONTROL

- A. Manufacturers Field Service: Provide service of a factory authorized technical service representative to inspect and approve the substrate before application and to instruct the applicator on the product and application method to be used.

3.5 CLEANING

- A. Protective Covering: Remove protective coverings from adjacent surfaces and other protective areas.

TECHNICAL SPECIFICATIONS FOR GLENDALE FIRE STATION
SECTION 07930 WATER REPELLENTS

- B. Immediately clean water repellent from adjoining surfaces and surfaces soiled or damaged by water repellent application as work progresses. Repair damage caused by water repellent application. Comply with manufacturers written cleaning instructions.

END OF SECTION

TECHNICAL SPECIFICATIONS FOR GLENDALE FIRE STATION
SECTION 08110 STEEL DOORS AND FRAMES

PART 1 - GENERAL

1.01 DEFINITIONS

- A. Terms:
 - 1. Alloyed coating: Same as galvanized.
 - 2. Galvanized: Zinc-iron alloy-coated steel sheet by hot dip process on galvanized steel sheet producing non-spangled coating characterized by dull gray appearance.
 - 3. Paint grip: Same as galvanized coating; term used in some industry areas.
 - 4. Galvanizing: Zinc coated steel by the hot dip process characterized by multi-faceted crystal structure occurring during normal solidification of hot dip zinc coating on steel sheet; generally referred to as spangle.

1.02 SYSTEM DESCRIPTION

- A. Performance requirements, primer paints and surface preparation: Coordinate surface preparation and primer paint selection to be compatible with final finish paints. Use paints specified in Paints Section as basis for selections.

1.03 QUALITY ASSURANCE

- A. Qualifications:
 - 1. Manufacturer/fabricator: Member of S.D.I. and listed in "Acceptable Manufacturers" Paragraph.
- B. Certifications: Furnish fire-rated components bearing factory-applied labels of UL, FMRC, or WH; give component rating.

PART 2 - PRODUCTS

2.01 MANUFACTURERS

- A. Acceptable manufacturers:
 - 1. Amweld Building Products, Inc.
 - 2. Ceko Door Products.
 - 3. Curries Company.
 - 4. S.W. Fleming Limited.
 - 5. Meeker Door, Inc.
 - 6. Pioneer Industries.
 - 7. Republic Builders Products Corp.
 - 8. Steelcraft.

2.02 MATERIALS

- A. Steel:

TECHNICAL SPECIFICATIONS FOR GLENDALE FIRE STATION
SECTION 08110 STEEL DOORS AND FRAMES

1. ASTM A366A-96, cold rolled steel sheet free of scale, pitting or surface defects.
 2. Galvanized frames and doors:
 - a. Type: ASTM A653A-96, zinc coated, coating designation G60.
 - b. Galvanized steel locations:
 - 1) Exterior openings.
 - 2) Kitchens.
 - 3) Toilets.
 3. Galvannealed coating: ASTM A653A-96, zinc coated, coating designation A25 permitted for door and frame units not requiring galvanizing indicated in "b." above. Note: This coating does not require factory primer.
 4. Wipe coat galvanized steel (WCGS) components are prohibited.
- B. Primer paint minimum requirements for field finished units; use shop primer compatible with Paints Section specified primers and topcoats; primer not required for door and frame units fabricated using galvannealed coating: One coat manufacturer's standard baked-on enamel, pinhole free, rust-inhibitive primer; 0.7 mils DFT minimum thickness.
- C. Door hardware: Specified in Door Hardware Section.
- D. Glass: Specified in Glazing Section.

2.03 MANUFACTURED UNITS

- A. Frame construction:
1. General:
 - a. Roll formed or pressed steel frames for doors, sidelights, tubular mullions and borrowed lights, and other indicated openings.
 - b. Dust cover boxes or mortar guards: Not less than 26 gauge steel at hardware mortises to be set in masonry partitions.
 - c. Reinforcement for scheduled hardware: S.D.I.-107-84, galvanized for galvanized units, and as follows:
 - 1) Hinge: Eight gauge, minimum.
 - 2) Strike: 16 gauge, minimum.
 - 3) Closer: 14 gauge, minimum.
 - 4) Projection weld to frame.
 2. Welded frame:
 - a. Welded steel corner construction; weld type; use for appropriate frame construction:
 - 1) Roll formed frames:
 - a) Standard of quality: Ceco Door Products; Welding Type T-3.
 - b) Characteristics: Machine-mitered corners with faces mitered, butted stops; full weld joints, outside face weld and full web weld.
 - 2) Pressed steel frames:
 - a) Standard of quality: Ceco Door Products; Welding Type V-4.

TECHNICAL SPECIFICATIONS FOR GLENDALE FIRE STATION
SECTION 08110 STEEL DOORS AND FRAMES

- b) Characteristics: Saw-mitered corners with faces and stops mitered; full weld joints, inside face weld only.
 - b. Welded frames with temporary spreaders during shipment, handling, and installation.
 - c. Gauge: 16 gauge.
 - d. Stops: 518" deep minimum.
 - e. Labels: Attached label for labeled openings.
 - 3. Manufacturer's standard rubber, neoprene, or silicone silencers; locations indicated below.
- B. Frame anchors:
- 1. Wall anchors for frame attachment to masonry construction:
 - a. Type: Adjustable, flat, corrugated, or perforated, T-shaped anchors with leg not less than 18 gauge by 2" wide by 10" long; hot dip galvanized.
 - b. Anchors at 2'-0" O.C., maximum, each jamb.
 - c. UL type anchors for fire-rated frames.
 - 2. Wall anchors for frame attachment to gypsum board partitions:
 - a. Manufacturer's standard adjustable metal stud type; 18 gauge, minimum.
 - b. Manufacturer's standard closed steel stud anchor (CSSA); 18 gauge, minimum.
 - c. Anchors at 2'-0" O.C., maximum, each jamb.
 - d. UL type anchors for fire-rated frames.
 - 3. Floor anchors: Clip type to receive two fasteners per clip, 18 gauge steel, minimum; use additional jamb anchor where floor anchor can not be used.
- C. Door construction:
- 1. General:
 - a. Reinforcement for scheduled hardware: S.D.I.-10784, galvanized for galvanized units, galvanized for galvanized units and as follows:
 - 1) Door hinge: Eight gauge, minimum.
 - 2) Lock: 16 gauge, minimum.
 - 3) Closer: 14 gauge, minimum.
 - 4) Projection weld to door.
 - b. End closures; top and bottom: Flush channel treatment with no holes or openings; inverted channel prohibited on doors.
 - c. Prohibited practice: Visible joints or seams on exposed faces.
 - 2. Classification:
 - a. Exterior units:
 - 1) Grades, models, and gauge: SDI Designation Grade III, Extra Heavy
 - 2) Construction: SDI Designation Hollow Metal.
 - 3) Core: Honeycomb.
 - b. Interior units:

TECHNICAL SPECIFICATIONS FOR GLENDALE FIRE STATION
SECTION 08110 STEEL DOORS AND FRAMES

- 1) Closets, bathroom, individual office, and storage rooms:
 - a) SDI Designation: Grade I, Standard Duty, Model 1, Full Flush; Hollow Metal; 20 gauge material.
 - b) Core for closets and storage rooms: Honeycomb.
 - c) Core for bathrooms, toilet rooms, individual offices: Polystyrene (EPS) board full door thickness bonded to facer sheets.
- 2) Other locations:
 - a) SDI Designation: Grade II, Heavy Duty, Model 2, Seaml Hollow Metal; 18 gauge material; full welded seam or st welded and interlocking channels with epoxy seam filler
 - b) Core: Polystyrene (EPS) board bonded to facer sheets.
- c. Rated units: SDI Designation Grade Ii, Heavy Duty, Model 2, Seamless, Hollow Metal; 18 gauge material; full door thickness polystyrene (EPS) board bonded to facer sheets.
- d. Mechanically join rails to stile forming neat face seam.
- D. Applied stops: Formed, 20 minimum gauge steel with mitered corners; prepare for gasket, if indicated. Attach using countersunk oval head machine screws at 1'-0" O.C. maximum.
- E. Fire resistant glazing sealant, acceptable product: IReactorseal, Inc.; Metalcaulk Series for installation of wire glass in openings.

2.04 FABRICATION

- A. Shop assembly:
 1. General:
 - a. Fabricate members in accord with S.D.I.-100-91, except where more stringent requirements are specified, Using fabricators other than S.D.I. member is prohibited.
 - b. Fabricate doors and frames to sizes and profiles indicated on reviewed shop *drawings*; provide specified *joinery* matching *approved* samples. c, Glaze using indicated glazing and sealant type.
 2. Hardware preparation:
 - a. Factory prepare units for hardware in accord with templates furnished under Door Hardware Section and in accord with S.D.I.-100-91.
 - b. Reinforcement: Reinforce components for hardware installation in accord with S.D.I.-107-84.
 - c. Punch single leaf frames to receive three silencers; double frames to receive one silencer per teat, at head. Install silencers.
 3. Completed units required to meet requirements indicated in ANSI A250.8.
- B. Shop finishing:
 1. Preparation prior to primer application; primer not required for galvanized coating:
 - a. Grind smooth and flush welds exposed in final construction;

TECHNICAL SPECIFICATIONS FOR GLENDALE FIRE STATION
SECTION 08110 STEEL DOORS AND FRAMES

- mechanically clean, SSPC-SP3, weld flux and mill scale from exposed and concealed surfaces.
- b. Repair abraded or damaged galvanized surfaces prior to application of surfacing materials. Prepare surfaces in accord with SSPC-SP2, Hand Tool Cleaning or SSPC-SP3, Power Tool Cleaning, minimum. Apply zinc rich primer meeting SSPC-Paint 20, Type I, Inorganic at 2.5 mils OFT, minimum.
 - c. Ferrous metals, not galvanized:
 - 1) Clean surfaces after fabrication and immediately prior to shop painting in accord with SSPC-SP2, Hand Tool Cleaning; SSPC-SP3, Power Tool Cleaning; or SSPC-SP6, Commercial Blast Cleaning, Surface cleaning requirements are dependent on final service location and environment. Solvent clean in accord with SSPC-SP1 to remove grease, oil, and contaminants; wipe dry with dry cloth.
 - 2) Apply primer specified in Primer paint Paragraph in MATERIALS Article above to specified mils OFT. Apply within four hours after cleaning and before rust-bloom occurs. Paint only in conditions acceptable to shop primer paint manufacturer's application data.
 - d. Galvanized metal:
 - 1) Repair abraded or damaged galvanized surfaces prior to application of surfacing materials. Prepare surfaces in accord with SSPC-SP2-1982, Hand Tool Cleaning or SSPC-SP3-1982, Power Tool Cleaning; apply zinc rich primer meeting SSPC-Paint 20, Type I, Inorganic at 2.5 mils DFT, minimum.
 - 2) Wash with xylol to remove grease, oil, and contaminants; wipe dry with dry cloth.
 - 3) Prepare galvanized sheared surfaces in same manner as "Ferrous metals, not galvanized" subparagraph above.
 - 4) Apply primer specified in "Primer paint" Paragraph in MATERIALS Article above to specified mils DFT.
2. Coat entire frames and accessories after fabrication, inside and outside; primer not required for galvanized coating.
 3. Coat entire doors after fabrication; primer not required for galvanized coating.
- C. Tolerances:
1. Frames:
 - a. Overall dimensions: $\pm 3/64$ " in opening height; $+1/16$ ", $-1/32$ " in opening width.
 - b. Throat opening: $\pm 1/16$ ".
 - c. Frame depth: $\pm 1/32$ ".
 2. Doors:
 - a. Overall dimensions: $\pm 3/64$ " maximum variation in width and length; $\pm 1/16$ " variation in thickness.
 - b. Door squareness: $\pm 1/16$ " variation in diagonal dimension.

TECHNICAL SPECIFICATIONS FOR GLENDALE FIRE STATION
SECTION 08110 STEEL DOORS AND FRAMES

- c. Flatness: X3132" when measured with straight edge from corner to corner; each face.
3. Other tolerances: Indicated in S.D.I.-117-88.

PART 3 - EXECUTION

3.01 EXAMINATION

- A. Verification of conditions: Verify openings and accessories are in correct position.

3.02 INSTALLATION

- A. Setting frames:
 1. General: Install in accord with S.D.I.-105-92, S.D.I.-110-84, and as follows.
 2. Welded frames:
 - a. Set welded frames in position prior to beginning partition work. Brace frames until permanent anchors are set.
 - b. Set anchors for frames as construction activities progress. Install anchors at *hinge and* strike levels. Provide *mortar guards at frame* mortises in masonry walls.
 - c. Remove temporary braces and spreaders after wall construction is complete.
 - d. Fire-rated frames: Install in accord with requirements of NFIPA 80-1995.
 - e. Install welded frames in prepared openings in concrete and masonry walls using countersunk bolts or expansion shields and anchors in accord with S.D.I.-111-F-91; fill or plug frame hole completely after doors and hardware are installed.
- B. Door installation
 1. Install steel doors in frames, use hardware specified in Door Hardware.
 2. Edge clearances at doors
 - a. Between door frame, at head and jambs: 1/8"
 - b. Meeting edges of door pairs and at mullions: 1/8"
 - c. Transom panels, without transom bars: 1/8"
 - d. Sills:
 - 1) Without thresholds: 3/8" maximum above finish floor.
 - 2) With thresholds: 3/4" Maximum above finish floor.
 3. Fire-rated doors: Install in accord with requirements of NFIPA 80-1995.

END OF SECTION 08110

TECHNICAL SPECIFICATIONS FOR GLENDALE FIRE STATION
SECTION 08210 – WOOD DOORS

PART 1 - GENERAL

1.01 WARRANTY

A. Special warranty:

1. Doors:
 - a. Interior doors: Life of installation.
 - b. Causes for replacement:
 - 1) Delamination.
 - 2) NWWDA I.S. 1-A-93, T-1: Telegraphing of stile, rail, or core through face causing surface variation exceeding 1/100" in any 3" span.
 - 3) NWWDA I.S. 1-A-93, T-2: Warp or twist exceeding 1/4" in door face plane.
2. Provide for finished replacement; include Project site refinishing, labor, and materials.

PART 2 - PRODUCTS

2.01 MANUFACTURERS

A. Acceptable manufacturers:

1. Five ply flush doors:
 - a. Algoma Hardwoods, Inc.
 - b. Buell Door Company.
 - c. Eggers Industries, Inc.
 - d. Weyerhaeuser Company.
 - e. VT Industries, Inc.
2. Plastic laminate flush doors:
 - a. Algoma Hardwoods, Inc.
 - b. Buell Door Company.
 - c. Eggers Industries, Inc.
 - d. Oshkosh Architectural Door Company.
 - e. Weyerhaeuser Company.
 - f. VT Industries, Inc.
3. Stile and rail look doors: International Paper; Masonite Division Molded Products Group.

2.02 MANUFACTURED UNITS

A. Flush doors:

1. Solid core:
 - a. Type: NWWDA I.S. 1-A-93, Premium Grade.
 - b. Assembly, general:
 - 1) Wood veneer: NWWDA I.S. 1-A-93, PC-5; five ply construction.
 - 2) Plastic laminate face: SLC-HPDL-5; five ply construction.
 - c. Core: ANSI A208.1, 1-LD-2 grade particleboard core.
 - d. Vertical and horizontal edges: Bonded to solid core; NWWDA T.M.6, Type II gluelines, minimum.
 - e. Adhesive: Commercial Standard CS-171, Type I for exterior and high moisture doors; Type II for other interior doors.
 - f. Blocking and reinforcement: No blocking required for TimberStrand® LSL or stave core doors. Provide particleboard core doors with solid wood blocking such as wide top rails and lock blocks for surface hardware such as closers and exit devices.

TECHNICAL SPECIFICATIONS FOR GLENDALE FIRE STATION
SECTION 08210 – WOOD DOORS

- g. Stiles; bonded to core:
 - 1) Wood veneer: Matching hardwood 1-3/8" minimum two ply.
 - 2) Plastic laminate face: Factory applied plastic laminate stiles laminated to manufacturer's standard construction hardwood; 1-3/8" minimum.
- h. Rails , moldings, and trim; NWWDA I.S. 1-A-93, G-12: Hardwood rails or TimberStrand® LSL, 1-1/8" minimum.
- i. Label: UL or WH 20 minute label on doors indicated to be 20 minute rated.
- 2. Mineral core:
 - a. Type: NWWDA I.S. 1-A-93, Custom Grade.
 - b. Assembly, general: NWWDA I.S. 1-A-93, FD-5 90 MIN, B label; FD-5 60 MIN, B label; FD-5 45 MIN, C label; or FD-5 20 MIN, 20 min. five ply construction; label requirements indicated on Drawings.
 - c. Core: Asbestos free mineral composition core; salt free.
 - d. Vertical and horizontal edges: Bonded to core; NWWDA T.M.6, Type II gluelines.
 - e. Adhesive: Commercial Standard CS-171, Type II.
 - f. Blocking, rails, and reinforcement; salt free:
 - 1) NWWDA I.S. 1-A-93: Provide lock blocks for scheduled locks. Provide blocking for other scheduled surface hardware attachment directly into blocking.
 - 2) Top and bottom rails 2" minimum before fitting, Georgia-Pacific Firestop® II high-density mineral with 1130 lb. screw holding power minimum.
 - g. Stiles; salt free:
 - 1) 1¼" minimum before fitting, Georgia-Pacific Firestop® II high density mineral with 1130 lb. screw holding power minimum with
 - a) Wood veneer: veneer to match face veneer.
 - b) Plastic laminate face: factory applied plastic laminate.
 - 2) Bonded to core. Drill 5/32" pilot holes for hinge screws at factory prior to shipment for "B" and "C" label fire doors.
 - 3) Meet following performance criteria:
 - a) Split resistance; tested in accord with "*Test Method to Determine Split Resistance of Hinge Edges of Composite Type Fire Doors*": Average of ten test samples shall be not less than 900 load pounds.
 - b) Direct screw withdrawal; ASTM D1037-96a: Average of ten test samples shall be not less than 650 load pounds when tested for direct screw withdrawal using No. 12 x 1¼" steel thread-to-the-head wood screw of cadmium plated or rust-resistant type.
 - c) Cycle/Slam; ANSI A151.1, Section 2.5: 200,000 cycles with no loose hinge screws or other visible signs of failure.
 - h. Moldings, and trim; salt free; NWWDA I.S. 1-A-93, G-12: Fire-retardant treated maple or birch.
 - i. Core: Asbestos and salt free mineral composition core.
 - j. Labels: UL or WH factory applied labels for ratings indicated on Drawings in excess of 30 minute requirements allowed above in "Solid core" Subparagraph above.
- 3. Doorskins:
 - a. Paint finish: Medium density overlay (MDO); overlay readily sandable, weatherproof, and carry a Class "B" Fire Rating.
 - b. Plastic laminate faces for HPDL:
 - 1) NEMA Standard LD-3.1-1991, Grade GP-50.
 - 2) Colors and patterns: Indicated on Drawings.

TECHNICAL SPECIFICATIONS FOR GLENDALE FIRE STATION
SECTION 08210 – WOOD DOORS

4. Furnish astragals at meeting edge of door pair, wood beads, and applied moldings; same material and quality as door face; meet NWWDA Grade.
 5. Thickness: 1-3/4" thickness unless otherwise indicated.
- B. Stile and rail look doors:
1. Type: NWWDA I.S. 1-A-93, Grade II, Type II and AWI Section 1300, Custom Grade.
 2. Construction: Three-ply construction; low-density wood fiber core.
 3. Faces: International Paper; Masonite Division Molded Products Group; Craftmaster® Coventry® textured face molded four panel CraftCore® solid core.
 4. Thickness: 1-3/4".
 5. Label: UL or WH 20 minute label on solid core doors indicated to be 20 minute rated.
- C. Fire resistant glazing sealant, acceptable product: Rectorseal, Inc.; Metalcaulk Series for installation of wire glass in openings.

2.03 FABRICATION

- A. Shop assembly:
1. Fabricate doors to NWWDA I.S. 1-A-93, G-13 Workmanship and AWI Sections 1300 and 1400 as applicable for Grade specified and specified criteria. Generally, utilize hot press method for face lay up; bond stiles, rails, and faces to core material.
 2. Fabrication details; use below unless otherwise indicated:
 - a. Meeting edge for door pairs:
 - 1) Non-rated and 20 minute doors: NWWDA I.S. 1-A-93, G-12, Option E4 Tee Astragal.
 - 2) Rated doors: NWWDA I.S. 1-A-93, G-12, Option E7 Metal Edge Guard Astragal.
 - b. Vision panel trimming:
 - 1) Non-rated and 20-minute doors: NWWDA I.S. 1-A-93, G-12, Option M3, Lip Moulding for glazing, same rating as door.
 - 2) Rated doors: NWWDA I.S. 1-A-93, G-12, Option M4 Metal Vision Frame.
 3. Cut and fit to sizes and supplied hardware templates prior to finishing.
 4. Fabricate openings in labeled doors in accord with manufacturer's inspection service procedure and under label service; finish.
 5. Seal edges and machined surfaces immediately after fitting and cutting.
- B. Tolerances:
1. Not prefit doors; width, height, and thickness: $\pm 1/16"$.
 2. Machined for hardware:
 - a. Width: $\pm 1/32"$.
 - b. Height and thickness: $\pm 1/16"$.
 - c. Hardware location: $\pm 1/32"$.
 - d. Locks and hinges: $+1/32" -0$.
 3. Prefit clearances:
 - a. Top and hinge edge: $1/8"$.
 - b. Single door lock edge: $1/8"$.
 - c. Pair meeting edge, per leaf: $1/16"$.
 4. Squareness: Maximum $1/8"$ difference in diagonal measurements.

2.04 SOURCE QUALITY CONTROL

TECHNICAL SPECIFICATIONS FOR GLENDALE FIRE STATION
SECTION 08210 – WOOD DOORS

- A. Inspection:
 - 1. Allowable color and grade variation: Select doors for natural finish for uniformity in color and grain and inconspicuous joints in face veneers.
 - 2. Adjacent doors and doors viewed together with color and grain meeting NWWDA standards specified above.
- B. Verification of performance: Stamp, brand, or label each door identifying manufacturer, trade association of which he is member, grade and type of door, or complying industry standard.

PART 3 - EXECUTION

3.01 INSTALLATION

- A. General:
 - 1. Install in accord with NWWDA I.S. 1-A-93, G-20, *Care and Installation at Job Site*.
 - 2. Provide cutouts for door grilles and glass lites, without damage to door faces if not factory prepped. Field fabricated openings in rated doors are prohibited.
 - 3. Machine doors for hardware using templates furnished by door hardware manufacturer, if not factory prepped.
 - 4. Seal cut-outs immediately after cutting or machining with one coat of solvent type sealer.
 - 5. Replace or rehang doors which bind or sag and doors with improper machining or cut-outs visible in finished construction activities.
 - 6. Clean soil and smudge marks and handling defects from doors. Replace doors from which marks cannot be removed.
 - 7. Install fire-rated doors in accord with requirements of NFPA 80-1995. Removing rating labels is prohibited.
 - 8. Finishing paint grade veneers and edges: In accord with Paints Section.
- B. Tolerances:
 - 1. Variation from specified clearances: +1/32", -0.
 - 2. Variation in edge alignment, pairs of doors, each leaf: 1/16" maximum.
 - 3. Clearances around door perimeter:
 - a. Hinge side: 1/16".
 - b. Latch edge: 1/8" (+0", -1/16").
 - c. Meeting edges, pairs of doors: 1/8" total.
 - d. Bottoms: 1/4" above threshold or floor finish except where undercutting is indicated.

END OF SECTION 08210

TECHNICAL SPECIFICATIONS FOR GLENDALE FIRE STATION
SECTION 08360 – SECTIONAL OVERHEAD DOORS
PART 1 GENERAL

1.1 SECTION INCLUDES

- A. Steel Sectional Overhead Doors.
- B. Electric Operators and Controls.
- C. Operating Hardware, tracks, and support.

1.2 RELATED SECTIONS

- A. Section 03300 - Cast-In-Place Concrete: Prepared opening in concrete. Execution requirements for placement of anchors in concrete wall construction.
- B. Section 04810 - Unit Masonry Assemblies: Prepared opening in masonry. Execution requirements for placement of anchors in masonry wall construction.
- C. Section 05500 - Metal Fabrications: Steel frame and supports.
- D. Section 06100 – Rough Carpentry
- E. Section 06402 – Interior Architectural Woodwork
- F. Section 07901 - Joint Sealers: Perimeter sealant and backup materials.
- G. Section 08710 - Door Hardware: Cylinder locks.
- H. Section 09910 – Light Commercial / Residential Painting: Field painting.
- I. Section 11150 – Parking Control Equipment: Remote door control.

1.3 REFERENCES

- A. [ANSI/DASMA 102](#) - American National Standard Specifications for Sectional Overhead Type Doors.

1.4 DESIGN / PERFORMANCE REQUIREMENTS

- A. Wind Loads: Design and size components to withstand loads caused by pressure and suction of wind acting normal to plane of wall as calculated in accordance with applicable code.
 - 1. Design pressure of 31 / -31 lb/sq ft
- B. Wiring Connections: Requirements for electrical characteristics.
 - 1. 115 volts, single phase, 60 Hz. **(CONTRACTOR TO VERIFY ELECTRICAL REQUIREMENTS)**
- C. Single-Source Responsibility: Provide doors, tracks, motors, and accessories from one manufacturer for each type of door. Provide secondary components from source acceptable to manufacturer of primary components.

TECHNICAL SPECIFICATIONS FOR GLENDALE FIRE STATION
SECTION 08360 – SECTIONAL OVERHEAD DOORS

1.5 SUBMITTALS

- A. Submit under provisions of Section 01300.
- B. Product Data: Manufacturer's data sheets on each product to be used, including:
 - 1. Preparation instructions and recommendations.
 - 2. Storage and handling requirements and recommendations.
 - 3. Installation methods.
- C. Shop Drawings: Indicate plans and elevations including opening dimensions and required tolerances, connection details, anchorage spacing, hardware locations, and installation details.
- D. Manufacturer's Certificates: Certify products meet or exceed specified requirements.
- E. Operation and Maintenance Data.

1.6 QUALITY ASSURANCE

- A. Manufacturer Qualifications: Company specializing in manufacturing products specified in this section with minimum five years documented experience.
- B. Installer Qualifications: Authorized representative of the manufacturer with minimum five years documented experience.
- C. Products Requiring Electrical Connection: Listed and classified by Underwriters Laboratories, Inc. acceptable to authority having jurisdiction as suitable for purpose specified.

1.7 DELIVERY, STORAGE, AND HANDLING

- A. Store products in manufacturer's unopened labeled packaging until ready for installation.
- B. Protect materials from exposure to moisture until ready for installation.
- C. Store materials in a dry, ventilated weathertight location.

1.8 PROJECT CONDITIONS

- A. Pre-Installation Conference: Convene a pre-installation conference just prior to commencement of field operations, to establish procedures to maintain optimum working conditions and to coordinate this work with related and adjacent work.

PART 2 PRODUCTS

2.1 MANUFACTURERS

- A. Acceptable Manufacturer: Overhead Door Corp., 2501 S. State Hwy. 121, Suite 200, Lewisville, TX 75067. ASD. Tel. Toll Free: (800) 275-3290. Phone: (469) 549-7100. Fax: (972) 906-1499. Web Site: www.overheaddoor.com. E-mail: sales@overheaddoor.com.
- B. Substitutions: Not permitted.

TECHNICAL SPECIFICATIONS FOR GLENDALE FIRE STATION
SECTION 08360 – SECTIONAL OVERHEAD DOORS

- C. Requests for substitutions will be considered in accordance with provisions of Section 01600.

2.2 SECTIONAL STEEL OVERHEAD DOORS

- A. Sectional Overhead Steel Doors: 430 Series Steel Doors by Overhead Door Corporation. Units shall have the following characteristics:
1. Door Assembly: Steel door assembly with rabbeted meeting rails to form weathertight joints and provide full-width interlocking structural rigidity.
 - a. Panel Thickness: 2 inches (51 mm).
 - b. Exterior Surface: Ribbed.
 - c. Section Material: Nominal 24 gauge, galvanized steel.
 - d. Center and End Stiles: 16 gauge steel.
 - e. Springs:
 - 1) 10,000 cycles.
 - 2) 25,000 cycles.
 - 3) 50,000 cycles.
 - 4) 75,000 cycles.
 - 5) 100,000 cycles.
 - f. Partial Glazing of Steel Panels:
 - 1) Non-Insulated double strength glass, 24 inch by 7 inch (610 mm by 178 mm) window.
 - g. Full Glazed Aluminum Sash Panels:
 - 1) Acrylic glazing.
 - 2) 1/8 inch (3 mm) double strength glass.
 2. Finish and Color: Two coat baked-on polyester, white color.
 3. Windload Design: Provide to meet the Design/Performance requirements specified.
 4. Hardware: Galvanized steel hinges and fixtures. Ball bearing rollers with hardened steel races.
 5. Lock:
 - a. Interior mounted slide lock.
 - b. Interior mounted slide lock with interlock switch for automatic operator.
 - c. Keyed lock.
 - d. Keyed lock with interlock switch for automatic operator.
 - e. Locking mechanism designed to maintain security for exterior while permitting break out when impacted from the inside.
 6. Weatherstripping:
 - a. Flexible bulb-type strip at bottom section.
 - b. Flexible Jamb seals.
 - c. Flexible Header seal.
 7. Track: Provide track as recommended by manufacturer to suit loading required and clearances available.
 8. Manual Operation: Pull rope.
 9. Manual Operation: Chain hoist.
 10. Electric Motor Operation: Provide UL listed electric operator, size and type as recommended by manufacturer to move door in either direction at not less than 2/3 foot nor more than 1 foot per second. Operator shall meet UL325/2010 requirements for continuous monitoring of safety devices.
 - a. Entrapment Protection: Required for momentary contact, includes radio control operation.
 - 1) Pneumatic sensing edge up to 18 feet (5.5 m) wide. Constant contact only complying with UL 325/2010.
 - 2) Electric sensing edge monitored to meet UL 325/2010.

TECHNICAL SPECIFICATIONS FOR GLENDALE FIRE STATION
SECTION 08360 – SECTIONAL OVERHEAD DOORS

- 3) Photoelectric sensors monitored to meet UL 325/2010.
- b. Operator Controls:
 - 1) Push-button operated control stations with open, close, and stop buttons.
 - 2) Key operated control stations with open, close, and stop buttons.
 - 3) Push-button and key operated control stations with open, close, and stop buttons.
 - 4) Flush mounting.
 - 5) Surface mounting.
 - 6) Interior location.
 - 7) Exterior location.
 - 8) Both interior and exterior location.
- c. Special Operation:
 - 1) Pull switch.
 - 2) Vehicle detector operation.
 - 3) Radio control operation.
 - 4) Card reader control.
 - 5) Photocell operation.
 - 6) Door timer operation.
 - 7) Commercial light package.
 - 8) Explosion and dust ignition proof control wiring.

PART 3 EXECUTION

3.1 EXAMINATION

- A. Do not begin installation until openings have been properly prepared.
- B. Verify wall openings are ready to receive work and opening dimensions and tolerances are within specified limits.
- C. Verify electric power is available and of correct characteristics.
- D. If preparation is the responsibility of another installer, notify Architect of unsatisfactory preparation before proceeding.

3.2 PREPARATION

- A. Clean surfaces thoroughly prior to installation.
- B. Prepare surfaces using the methods recommended by the manufacturer for achieving the best result for the substrate under the project conditions.

3.3 INSTALLATION

- A. Install overhead doors and track in accordance with approved shop drawings and the manufacturer's printed instructions.
- B. Coordinate installation with adjacent work to ensure proper clearances and allow for maintenance.
- C. Anchor assembly to wall construction and building framing without distortion or stress.

TECHNICAL SPECIFICATIONS FOR GLENDALE FIRE STATION
SECTION 08360 – SECTIONAL OVERHEAD DOORS

- D. Securely brace door tracks suspended from structure. Secure tracks to structural members only.
- E. Fit and align door assembly including hardware.
- F. Coordinate installation of electrical service. Complete power and control wiring from disconnect to unit components.

3.4 CLEANING AND ADJUSTING

- A. Adjust door assembly to smooth operation and in full contact with weatherstripping.
- B. Clean doors, frames and glass.
- C. Remove temporary labels and visible markings.

3.5 PROTECTION

- A. Do not permit construction traffic through overhead door openings after adjustment and cleaning.
- B. Protect installed products until completion of project.
- C. Touch-up, damaged coatings and finishes and repair minor damage before Substantial Completion.

END OF SECTION

TECHNICAL SPECIFICATIONS FOR GLENDALE FIRE STATION
SECTION 08400 - GLASS, GLAZING AND ALUMINUM WINDOWS

PART 1 - GENERAL

1.1 GENERAL CONDITIONS:

- A. Drawings and general provisions of Contract, including General and Supplementary Conditions and Division 1 Specification Sections, apply to this Section.

1.2 SCOPE:

- A. Furnish all labor, materials, and equipment and perform all operations necessary for the complete installation of all glass, glazing, and aluminum windows as noted in these specifications and as shown on the drawings.

1.3 GLAZING:

- A. All glazing shall be done by experienced glaziers. Only high grade glazing compound shall be used. G. E. Silglaze 2400 Silicone Sealant. All surfaces to be glazed shall be clean and dry and no glazing shall be done in freezing weather. Face puttying shall be smooth and of uniform width, without ripples and all corners shall be cut clean and sharp.
- B. Rebates of glazed panels and doors shall be primed before installing glass and all glass shall be back puttied and bedded on all sides except as noted for plate glass. Heat absorbing glass shall be set as to allow free expansion and contraction of the materials.
- C. Each piece of glass shall bear the manufacturer's label of quality and the labels of quality and the labels shall remain in place until after inspection and approval of Architect. After inspection and approval the labels shall be removed and glass cleaned and polished, both sides.

1.4 SAFETY STANDARDS:

- A. All glazing shall comply with Safety Standards for Architectural Glazing 16CFR as issued by the Consumer Safety Commission.

1.5 GLASS:

- A. All exterior glass used in hollow metal frames and aluminum windows and store front shall be Thermopane Insulating Glass, 1" overall thickness, 3/16" thick exterior side bronze, 7/16" interior side clear as specified in paragraph 1.06, this section.

TECHNICAL SPECIFICATIONS FOR GLENDALE FIRE STATION
SECTION 08400 - GLASS, GLAZING AND ALUMINUM WINDOWS

- B. All glass used in doors, door lights, door side lights, glass view panels, and interior storefront other than in fire rated construction, shall be ¼” clear float tempered glass or safety glass. All glazing with 4 FT of doors shall be safety glass.
- C. Lavatory Mirrors as specified in Miscellaneous Section.
- D. All wireglass used in fire rated construction shall comply with CPSC 16 CFR 1201.

1.6 EXTERIOR ALUMINUM FRAME FIXED GLASS AND HOPPER TYPE WINDOWS:

- A. Exterior Aluminum Frame: Impact resistant windows shall match same configuration (single hung & hopper vent) windows as shown on the drawings.
- B. Design Criteria: Windows shall be designed to meet the following criteria:

Wind design criteria: 3 sec. Wind gust velocity = 165 mph
 Importance Factor = 1.0
 Design Wind Exposure = Category “C”
 Directionality Factor Kd = 1.00
 Internal Pressure Coefficient, GC pi = +0.18
 Components & Claddings

| Wall Area | Zone | Pounds/Sq. Ft. |
|------------|------|----------------|
| 10 sq. ft. | 5 | -91, +68 |
| 10 sq. ft. | 4 | -75, +68 |
| 50 sq. ft. | 5 | -77, +61 |
| 50 sq. ft. | 4 | -68, +61 |

- C. Requirements:
 1. AAMA Designation: C-AW65.
 2. Impact Designation: Casement project out (36” x 60” single vent unit) 100 psf Design Pressure large and Small Missile Window.
 3. Windows: 3 ¼” frame depth; extruded aluminum with integral structural polyurethane thermal break; vent overlaps frame; equal-leg frame; finish factory-applied; factory-assembled.
 4. Configuration: casement out swing; single vent per frame.

TECHNICAL SPECIFICATIONS FOR GLENDALE FIRE STATION
SECTION 08400 - GLASS, GLAZING AND ALUMINUM WINDOWS

5. Architectural Glazing: Vent glazing: Neoprene gasket: 1" insulating glass; silicone heel bead; glass description in paragraph 2.04; factory glazed.
6. Impact Glazing: Exterior Silicone with spacers; 1" insulating glass; silicone perimeter bead; EPDM gasket; interior aluminum glazing bead; glass description in paragraph 2.04: factory-glazed.
7. Performance Requirements: Conformance to C-AW65 specifications in AAMA/NWDA 101/1.S.2-97 when tests are performed on a 3'0" x 5'0" minimum frame size with the following test results:
 - a. Air Infiltration: after the AAMA 910-93 life cycle test, maximum .03 cfm/square foot when tested per ASTM E 283.04 at a static air pressure difference of 6.24 psf.
 - b. Water Penetration: after the AAMA 910-93 life cycle test, no uncontrolled water leakage when tested per ASTM E 331-00 at a static air pressure difference of 12 psf.
 - c. Uniform Deflection: no more than L/175 when tested per ASTM E 330-02 at a static air pressure difference of 65 psf. Design Pressure test to 100 PSF on the 37" x 63" window.
 - d. Uniform Structural: window to be operable, and maximum .2% permanent deformation per member when tested per ASTM E330-02 at a static air pressure difference of 97.5 psf. Downsized unit to 150 PSF for the 37" x 63" window.
8. Conformance to windborne cycling to Design Pressure as listed above per ASTM E when tested are performed on the prescribed 60" x 71" minimum test size with the following results:

Window units are to be tested to pass the enhanced performance requirements which demonstrate that the units will resist penetration of a 15lb 2 x 4 propelled at 50 mph (74 ft / sec), Kd=1.0.

9. Thermal testing per AAMA 1503-98, at the prescribed 6.0" x 4'0" test size glazed with 1" insulating glass made with 1/8" clear and 1/8" hard coat low E lights and argon, with the following test results:
 - a. Condensation Resistance Factor: minimum 57 frame and 64 glass CRF.
 - b. Thermal Transmittance: maximum 57 frame and 64 glass CRF.

D. Projected Windows:

1. AAMA designation: AP-AW65 (60" x 30") architectural Window;

TECHNICAL SPECIFICATIONS FOR GLENDALE FIRE STATION
SECTION 08400 - GLASS, GLAZING AND ALUMINUM WINDOWS

2. Impact Designation: Project out 60' x 70" (two vent unit) 100 psf Design Pressure Large and Small Missile Window.
3. Windows: 3-1/4" frame depth; extruded aluminum with integral structural polyurethane thermal break; vent overlaps frame; equal-leg frame; finish factory-applied; factory-assembled.
4. Configuration: project/out/awning; single vent and fixed.
5. Architectural Glazing: Vent glazing: Neoprene gasket; 1" insulating glass; silicone heel bead; EPDM gasket; interior aluminum glazing bead; glass description in paragraph 2.04; factory-glazed.
6. Impact Glazing: exterior silicone bead; 1" insulating glass; silicone perimeter bead; interior wedge EPDM gasket; aluminum glazing bead; glass description in paragraph 2.04; factory-glazed.
7. Performance Requirements: Conformance to AP-AW65 specifications in AAMA/NWWDA 101/I.S.2-97 when tests are performed on a 5'0" x 3'0" minimum frame size with the following test results:
 - a. Air Infiltration: after the AAMA 910-93 life cycle test, maximum .07 cfm/square foot when tested per ASTM E 283-04 at a static air pressure difference of 6.24 psf.
 - b. Water Penetration: after the AAMA910-93 life cycle test, no uncontrolled water leakage when tested per ASTM E 331-00 at a static air pressure difference of 15 psf.
 - c. Uniform Deflection: no more than L/175 when tested per ASTM E 330-02 at a static air pressure difference of 65 psf. Design Pressure test to 100 PSF on the 60" x 70" (two vent) window.
 - d. Uniform Structural: window to be operable, and maximum .2% permanent deformation per member when tested per ASTM E 330-02 at a static air pressure difference of 97.5 psf. Downsized test to 150 PSF for the 60" x 70" window.
8. Thermal testing per AAMA 1502.7-81, at the prescribed 4'0" x 6'0" test size glazed with 1" insulating glass made with 1/8" clear lites, with the following test results:
 - a. Condensation Resistance Factor: minimum 58 frame CRF.

TECHNICAL SPECIFICATIONS FOR GLENDALE FIRE STATION
SECTION 08400 - GLASS, GLAZING AND ALUMINUM WINDOWS

- b. Thermal Transmittance: maximum .62 BTU/HR/SQ.FT/F U value.
- E. Submittals: The following shall be included with the submittal
 - 1. Shop drawings: Window location chart; typical window elevations: details of assemblies, hardware, and glazing details for factory-glazed units.
 - 2. Product data: Manufacturer's specifications and test reports from an AAMA-accredited laboratory.
 - 3. Furnish a valid AAMA "Notice of Product Certification" indicating that the windows for the project conform to AAMA/NWWDA 101/I.S.2-97.
 - 4. Provide a Florida Product Approval number from the Florida Department of Community Affairs with the corresponding maximum size, water resistance levels and design pressure to meet the projects requirements for the largest product on the project.
 - 5. Furnish visible, permanent IGCC certification labels for the CBA rating level on double insulating glass units.
- F. Manufacturer's Warranties:
 - 1. Windows: Warrant for one year against defects in material or workmanship under normal use.
 - 2. Insulating glass units: Warrant seal for five years against visual obstruction from fill formation or moisture collection between internal glass surfaces, excluding that caused by glass breakage or abuse.
- G. Manufacturer:
 - 1. Specifications are written around the following manufacturers windows:
Traco LM 3500 project out impact thermal aluminum window.
 - 2. Materials:
 - a. Aluminum extrusion: Produced from commercial quality 6063-T5 alloy; free from defects impairing strength and durability.
 - b. Hardware: Concealed stainless steel hinges conforming to AAMA 904-01 to rotate vent outward on vertical axis; white bronze cam handles and strikes; stainless steel limit arm with release key.
 - c. Weatherstrip: secured in extruded ports; double rows of EPDM gasket on vent perimeters.
 - 3. Fabrication:
 - a. Frame and vent: All members double tubular: corners mitered,

TECHNICAL SPECIFICATIONS FOR GLENDALE FIRE STATION
SECTION 08400 - GLASS, GLAZING AND ALUMINUM WINDOWS

double gusset reinforced, factory-sealed with sealant conforming to AAMA 800-92, and crimped.

- b. Water control: Pressure equalization gasket on vent interior; vent and frame weeps, foam baffles, and exterior hoods to allow water to drain by gravity and resist wind-driven water.
- c. Drip cap: Field-mounted on frame exterior above vent hood.

H. Double Insulating Glass Units-Impact Glazing:

1. Performance: Dual-seal durability: conformance to ASTM E 774-00; visible, permanent IGCC certification label for CBA rating level.
2. Exterior glass lite:
 - a. Thickness: 3/16"
 - b. Tint: clear bronze
 - c. Type: Heat Strengthened
3. Interior glass lite:
 - a. Thickness: 7/16" Laminated
 - b. Tint: clear
 - c. Type: 3/16" heat strengthen/Saflex HP 100 PVB / 3/16" heat strengthen

I. Finish on Aluminum Extrusions:

1. Application: on clean extrusions free from serious surface blemishes: on exposed surfaces visible when installed product's operating ash are closed.
2. Coating: color anodize.
3. Quality standard: conforming to AAMA 611-98.
4. Thickness: AAM10C22A44 Class 1-.7 mils.
5. Color: #313 dark

J. Installation Accessories:

1. Material: extruded aluminum; nominal .062" wall; with exposed surfaces finished to match window color and finish performance; concealed fasteners; required weatherseals; designed for unrestricted expansion and contraction.
2. Exterior: Two-piece head and jamb receptor with thermal break; subsill with thermal break and end dams.

K. Execution:

TECHNICAL SPECIFICATIONS FOR GLENDALE FIRE STATION
SECTION 08400 - GLASS, GLAZING AND ALUMINUM WINDOWS

1. Installation:

- a. Install windows in accordance with manufacturer's recommendations and approved shop drawings with skilled craftspeople who have demonstrated a successful history of installing windows for five years.
- b. Provide required support shimming and securely fasten and set windows plumb, square, and level without twist or bow. Fastener spacing on the Impact tested unit is 4 inches from each end and 16 inches on center around the perimeter. Anchorage was an .062" aluminum angle clip with a # 10 SMS into the aluminum window and a #10 x 1 1/2" long fasteners.
- c. Apply sealant per sealant manufacturer's recommendations at joints, wipe off excess, and leave exposed sealant surfaces clean and smooth.

- L. Adjusting and Cleaning – Adjust windows as necessary for smooth and weathertight operation, and leave windows clean and free of construction debris.

1.07 ALUMINUM STOREFRONT FOR INTERIOR WINDOW WALLS AND GLAZING:

- A. General: All aluminum storefront is written around Kawneer Company products. Storefront and doors of comparable size, quality details, etc. of Vista Wall Architectural Products are acceptable as equal.
- B. Materials: All framing members shall be extruded aluminum of 6063-T6 alloy and temper. Exterior glazing gasket shall be E.P.D.M. and interior glazing seal shall be closed cell P.V.C. foam sealant tape. All mullions and horizontals for 1" glazing (except butt glazed) shall be thermally isolated from the pressure plate by a rigid vinyl separator.
- C. Systems: Shall be 2" x 4 1/2" for store front where shown and noted shall be Kawneer Tri-fab 451 series or Vistawall Series 3000. Systems shall be for 1/4" tempered glass glazing.
- D. Erections: All openings shall be prepared plumb and square by others and shall be of sufficient size to provide clearance at jambs, head and sill as shown on the architectural drawings. Installation, glass, and glazing shall be performed by experienced technicians and according to the manufacturer's recommended procedures. All units shall be securely anchored with all joints fully caulked to issue a watertight seal reinforcing at solid core wood door jambs shall be by installer.
- E. Finish: All exposed surfaces shall be free of unsightly scratches and blemishes. The exposed surfaces shall be receive a caustic etch followed by an architectural class I anodic color coating conforming to AA-M12C22A44 Vistawall 740-EC Dark Bronze or Kawneer Dark Bronze.

TECHNICAL SPECIFICATIONS FOR GLENDALE FIRE STATION
SECTION 08400 - GLASS, GLAZING AND ALUMINUM WINDOWS

- F. Cleaning: Upon completion of construction, the General Contractor shall be responsible for cleaning all aluminum, employed methods recommended by the manufacturer as follows Anodized aluminum shall be cleaned with plain water containing a mild detergent, or a petroleum product such as white gasoline, kerosene or distillate. No abrasive agent shall be used.
- G. See drawings for locations of storefront systems.

1.08 EXTERIOR GLAZING IN HOLLOW METALS FRAMES:

Glazing in exterior hollow metal framing shall be insulated impact glazing, same as specified for aluminum windows.

1.09 SHOP DRAWINGS:

Glass and glazing contractor shall furnish complete shop drawings for all items this Section for approval prior to fabrication showing all details, sizes, shapes, dimensions, etc.

Shop Drawings shall also include product approval number and additional test data that is required to comply with the current Florida Code.

1.10 CLEANING:

After Final Inspection, all remaining glazing compound and smears shall be cleaned from the glass, the sash and frames, and the glass washed clean. Broken glass shall be removed and replaced at no expense to the Owner.

END OF SECTION 08400

TECHNICAL SPECIFICATIONS FOR GLENDALE FIRE STATION
SECTION 08710 - DOOR HARDWARE

PART 1 - GENERAL

1.01 SUMMARY

- A. This Section includes items known commercially as finish or door hardware that are required for swing, sliding, and folding doors, except special types of unique hardware specified in the same sections as the doors and door frames on which they are installed.
- B. This Section includes the following:
1. Hinges
 2. Key control system
 3. Lock and latch sets
 4. Exit devices
 5. Push/Pull units
 6. Closers
 7. Overhead holders
 8. Miscellaneous door control devices
 9. Door trim units
 10. Protection plates
 11. Weatherstripping for exterior doors
 12. Astragals or meeting seals on pairs of doors
 13. Thresholds
 14. Door Seals
- C. Related Sections: The following Sections contain requirements that relate to this Section:
1. Section 08110: Steel Doors and Frames
 2. Section 08210: Wood Doors
 3. Section 08360: Sectional Overhead Doors
 4. Section 08410: Aluminum Entrances and Storefronts

1.02 REFERENCES

- A. Standards of the following as referenced:
1. American National Standards Institute (ANSI)
 2. Door and Hardware Institute (DHI)
 3. Factory Mutual (FM)
 4. National Fire Protection Association (NFPA)
 5. Underwriters' Laboratories, Inc. (UL)
 6. Warnock Hersey
- B. Regulatory standards of the following as referenced:

TECHNICAL SPECIFICATIONS FOR GLENDALE FIRE STATION
SECTION 08710 - DOOR HARDWARE

1. Department of Justice, Office of the Attorney General, *Americans with Disabilities Act*, Public Law 101-336 (ADA).
2. CABO/ANSI A117.1: *Providing Accessibility and Usability for Physically Handicap People*, 1992 edition.

1.03 SYSTEM DESCRIPTION

- A. Refer to applicable Headings for system description for electric and electro-pneumatic hardware products.

1.04 SUBMITTALS

- A. General: Submit the following in accordance with Conditions of Contract and Division 1 Specification sections.
- B. Product data including manufacturers' technical product data for each item of door hardware, installation instructions, maintenance of operating parts and finish, and other information necessary to show compliance with requirements.
- C. Final hardware schedule coordinated with doors, frames, and related work to ensure proper size, thickness, hand, function, and finish of door hardware.
 1. Final Hardware Schedule Content: Based on hardware indicated, organize schedule into vertical format "hardware sets" indicating complete designations of every item required for each door or opening. Use specification Heading numbers with any variations suffixed a, b, etc. Include the following information:
 - a. Type, style, function, size, and finish of each hardware item.
 - b. Name and manufacturer of each item.
 - c. Fastenings and other pertinent information.
 - d. Location of each hardware set cross referenced to indications on Drawings both on floor plans and in door and frame schedule.
 - e. Explanation of all abbreviations, symbols, and codes contained in schedule.
 - f. Mounting locations for hardware.
 - g. Door and frame sizes and materials.
 - h. Keying information.
 - i. Cross reference numbers used within schedule deviating from those specified.
 - 1) Column 1: State specified item and manufacturer.
 - 2) Column 2: State prior approved substituted item and its manufacturer.

TECHNICAL SPECIFICATIONS FOR GLENDALE FIRE STATION
SECTION 08710 - DOOR HARDWARE

2. Submittal Sequence: Submit final schedule at earliest possible date particularly where acceptance of hardware schedule must precede fabrication of other work that is critical in the Project construction schedule. Include with schedule the product data, samples, shop drawings of other work affected by door hardware, and other information essential to the coordinated review of schedule.
 3. Submittal Sequence: Submit initial draft of final schedule along with essential product data in order to facilitate the fabrication of other work that is critical in the Project construction schedule. Submit final schedule after samples, product data, coordinate with shop drawings of other work, delivery schedules, and similar information has been completed and accepted.
 4. Keying Schedule: Submit separate detailed schedule indicating clearly how the Owner's final instructions on keying of locks has been fulfilled.
- D. Samples of each type of exposed hardware unit in finish indicated and tagged with full description for coordination with schedule. Submit samples prior to submission of final hardware schedule.
1. Samples will be returned to the supplier. Units that are acceptable and remain undamaged through submittal, review, and field comparison process may, after final check of operation, be incorporated in the Work, within limitations of keying coordination requirements.
- E. Templates for doors, frames, and other work specified to be factory prepared for the installation of door hardware. Check shop drawings of other work to confirm that adequate provisions are made for locating and installing door hardware to comply with indicated requirements.
- F. Contract closeout submittals:
1. Operation and maintenance data: Complete information for installed door hardware.
 2. Warranty: Completed and executed warranty forms.

1.05 QUALITY ASSURANCE

- A. Single Source Responsibility: Obtain each type of hardware (latch and lock sets, hinges, closers, etc.) from a single manufacturer.
- B. Supplier Qualifications: A recognized architectural door hardware supplier, with warehousing facilities in the Project's vicinity, that has a record of successful in-service performance for supplying door hardware similar in quantity, type, and quality to that indicated for this Project and that employs an experienced architectural hardware consultant (AHC) who is available to

TECHNICAL SPECIFICATIONS FOR GLENDALE FIRE STATION
SECTION 08710 - DOOR HARDWARE

Owner, Architect, and Contractor, at reasonable times during the course of the Work, for consultation.

1. Require supplier to meet with Owner to finalize keying requirements and to obtain final instructions in writing.
2. Required supplier to meet with installer prior to beginning of installation of door hardware.

C. Fire-Rated Openings: Provide door hardware for fire-rated openings that complies with NFPA Standard No. 80 and requirements of authorities having jurisdiction. Provide only items of door hardware that are listed and are identical to products tested by UL, Warnock Hersey, FM, or other testing and inspecting organization acceptable to authorities having jurisdiction for use on types and sizes of doors indicated in compliance with requirements of fire-rated door and door frame labels.

1.06 PRODUCT HANDLING

- A. Tag each item or package separately with identification related to final hardware schedule, and include basic installation instructions with each item or package.
- B. Packaging of door hardware is responsibility of supplier. As material is received by hardware supplier from various manufacturers, sort and repackage in containers clearly marked with appropriate hardware set number to match set numbers of approved hardware schedule. Two or more identical sets may be packed in same container.
- C. Inventory door hardware jointly with representatives of hardware supplier and hardware installer until each is satisfied that count is correct.
- D. Deliver individually packaged door hardware items promptly to place of installation (shop or Project site).
- E. Provide secure lock-up for door hardware delivered to the Project, but not yet installed. Control handling and installation of hardware items that are not immediately replaceable so that completion of the Work will not be delayed by hardware losses both before and after installation.

1.07 WARRANTY

- A. Special warranties:
 1. Door Closers: Ten year period
 2. Exit Devices: Three year period

TECHNICAL SPECIFICATIONS FOR GLENDALE FIRE STATION
SECTION 08710 - DOOR HARDWARE

1.08 MAINTENANCE

- A. Maintenance Tools and Instructions: Furnish a complete set of specialized tools and maintenance instructions as needed for Owner's continued adjustment, maintenance, and removal and replacement of door hardware.
- B. Parts kits: Furnish manufacturers' standard parts kits for locksets, exit devices, and door closers.

PART 2 - PRODUCTS

2.01 MANUFACTURED UNITS

- A. Hinges:
 - 1. Acceptable manufacturers:
 - a. Hager Hinge Company
 - b. Lawrence Brothers
 - c. Stanley Works
 - d. Mont Hard*
 - 2. Characteristics:
 - a. Templates: Provide only template-produced units.
 - b. Screws: Provide Phillips flat-head screws complying with the following requirements:
 - 1) For metal doors and frames install machine screws into drilled and tapped holes.
 - 2) For wood doors and frames install threaded-to-the-head wood screws.
 - 3) For fire-rated wood doors install #12 x 1-1/4 inch, threaded-to-the-head steel wood screws.
 - 4) Finish screw heads to match surface of hinges or pivots.
 - c. Hinge pins: Except as otherwise indicated, provide hinge pins as follows:
 - 1) Out-Swing Exterior Doors: Non-removable pins.
 - 2) Out-Swing Corridor Doors with Locks: Non-removable pins.
 - 3) Interior Doors: Non-rising pins.
 - 4) Tips: Flat button and matching plug. Finished to match leafs.
 - d. Size: Size hinges in accordance with specified manufacturer's published recommendations.
 - e. Quantity: Furnish one pair of hinges for all doors up to 5'0" high. Furnish one hinge for each additional 2-1/2 feet or fraction thereof.
- B. Cylinders:
 - 1. Acceptable manufacturers:
 - a. Schlage Lock Co., Division of Ingersoll-Rand*
 - b. Russwin/Corbin

TECHNICAL SPECIFICATIONS FOR GLENDALE FIRE STATION
SECTION 08710 - DOOR HARDWARE

- c. Sargent
- 2. Characteristics:
 - a. Grandmaster key or masterkey to a new masterkey system.
 - b. Equip locks with manufacturer's special 6-pin tumbler cylinder with construction masterkey feature that permits voiding of construction keys without cylinder removal.
 - c. Metals: Construct lock cylinder parts from brass or bronze, stainless steel, or nickel silver.
 - d. Comply with Owner's instructions for masterkeying and, except as otherwise indicated, provide individual change key for each lock that is not designated to be keyed alike with a group of related locks.
 - 1) Permanently inscribe each key with number of lock that identifies cylinder manufacturer's key symbol, and notation, "DO NOT DUPLICATE."
 - e. Key Material: Provide keys of nickel silver only.
 - f. Key Quantity: Furnish 2 change keys for each lock, 4 master keys for each master system, and 4 grandmaster keys for each grandmaster system, and 6 construction master keys.
 - 1) Furnish one extra blank for each lock.
- C. Locksets, Latchsets:
 - 1. Acceptable manufacturers:
 - a. Schlage Lock Company*
 - b. Russwin/Corbin
 - c. Sargent
 - 2. Characteristics:
 - a. Locksets and Latchsets to be UL Listed standard duty cylindrical type, 2-3/4" backset.
 - b. Provide appropriate strikes, with lip to center dimensions required with wrought strike boxes.
 - c. Lock series and trim to be Schlage AL, Lever Neptune.
- D. Exit Devices:
 - 1. Acceptable manufacturers:
 - a. Von Duprin, Division of Ingersoll-Rand*
 - 2. Characteristics:
 - a. Exit devices shall be "UL" listed for life safety. All exit devices for fire rated openings shall have "UL" labels for "Fire Exit Hardware."
 - b. All exit devices mounted on labeled wood doors shall be thru-bolted mounted on the door per the door manufacturers requirements.
 - c. All trim shall be thru-bolted to the lock stile case.
 - d. All exit devices shall be made of brass, bronze, stainless steel, or aluminum material, plated to the standard architectural finishes to

TECHNICAL SPECIFICATIONS FOR GLENDALE FIRE STATION
SECTION 08710 - DOOR HARDWARE

match the balance of the door hardware. Painted or anodized aluminum finishes are not accepted.

- e. Provide glass bead conversion kits to shim exit devices on doors with raised glass heads.
- f. All exit devices shall be one manufacturer.
- g. All series exit devices shall incorporate a fluid damper, which decelerates the touchpad on its return stroke and eliminates noise associated with exit device operation. All exit devices shall be non-handed. Touchpad shall extend a minimum of 1/2 of the door width and shall be a minimum of 2-3/16" in height. Plastic touchpads are not acceptable. All latch bolts to be the deadlocking type. Latch bolts shall have a self-lubricating coating to reduce wear. Plated or plastic coated latch bolts are not acceptable.

E. Closers and Door Control Devices:

- 1. Acceptable manufacturers:
 - a. LCN Closers, Division of Ingersoll-Rand
- 2. Characteristics:
 - a. Door closers shall have fully hydraulic, full rack and pinion action with a high strength cast iron cylinder.
 - b. Hydraulic fluid shall be of a type requiring no seasonal closer adjustment for temperatures ranging from 120 degrees F (49 degrees C) to -30 degrees F (-35 degrees C).
 - c. Spring power shall be continuously adjustable over the full range of closer sizes, and allow for reduced opening force for the physically handicapped. Hydraulic regulation shall be by tamper-proof, non-critical valves. Closers shall have separate adjustment for latch speed, general speed and back check.
 - d. All closers shall have solid forged steel main arms (and forearms for parallel arm closers) and where specified shall have a cast-in solid stop on the closer shoe ("cush"). Where door travel on out-swing doors must be limited, use "cush" type closers. Auxiliary stops are not required when cushion type closers are used.
 - e. Overhead concealed closers shall have spring power adjustable for 50% increase in closing power and fully mortised door tracks.
 - f. All closers shall be certified to exceed ten million (10,000,000) full load cycles by a recognized independent testing laboratory. All closers (overhead, surface and concealed) shall be of one manufacturer and carry manufacturer's ten year warranty (electric closers to have two year warranty).
 - g. Access-Free Manual Closers: Where manual closers are indicated for doors required to be accessible to the physically handicapped provide

TECHNICAL SPECIFICATIONS FOR GLENDALE FIRE STATION
SECTION 08710 - DOOR HARDWARE

adjustable units complying with ADA and ANSI A-117.1 provisions for door opening force.

- h. Closers to be installed to allow door swing as shown on plans. Doors swinging into exit corridors shall provide for corridor clear width as required by code. Where possible, mount closers inside rooms.
- i. Powder coating finish to be certified to exceed 100 hours salt spray testing by ETL, an independent testing laboratory used by BHMA for ANSI certification.
- j. Combination Door Closers and Holders: Provide units designed to hold door in open position under normal usage and to release and automatically close door under fire conditions. Incorporate an integral electromagnetic holder mechanism designed for use with UL listed fire detectors, provided with normally closed switching contacts. Where Combination Door Closers, Holder, and Detectors are scheduled, provide integral UL Listed photo-electric 24V detector module.

F. Overhead Door Holders:

- 1. Acceptable manufacturers:
 - a. Glynn Johnson, Division of Ingersoll-Rand*
 - b. Rixson Firemark
- 2. Characteristics:
 - a. Provide heavy duty and medium duty door holders concealed and surface mounted of brass, bronze or stainless steel.
 - b. Concealed holders to be installed with the jamb bracket mortised flush with the bottom of the jamb. The arm and channel to be mortised into the door.
 - c. Holder to be installed with the jamb bracket mounted on the stop.

G. Floor Stops and Wall Bumpers:

- 1. Acceptable manufacturers:
 - a. Glynn Johnson
 - b. Ives
 - c. Rockwood Manufacturing*
- 2. Characteristics: Refer to Hardware Headings.

H. Push Plates:

- 1. Acceptable manufacturers:
 - a. Glynn Johnson
 - b. Ives
 - c. Rockwood Manufacturing*

TECHNICAL SPECIFICATIONS FOR GLENDALE FIRE STATION
SECTION 08710 - DOOR HARDWARE

2. Characteristics:
 - a. Exposed Fasteners: Provide manufacturers standard exposed fasteners.
 - b. Material to be bronze, per the Hardware Headings.
 - c. Provide plated sized as shown in Hardware Headings.

I. Door Pulls & Pull Plates:

1. Acceptable manufacturers:
 - a. Glynn Johnson
 - b. Ives
 - c. Rockwood Manufacturing*
2. Characteristics:
 - a. Provide concealed thru-bolted trim on back to back mounted pulls, but not for single units.
 - b. Material to be bronze.
 - c. Provide units sized as shown in Hardware Headings.

J. Push Pull Sets:

1. Acceptable manufacturers:
 - a. Glynn Johnson
 - b. Ives
 - c. Rockwood Manufacturing*
2. Characteristics:
 - a. Provide mounting systems as shown in hardware sets.
 - b. Material to be tubular, bronze.
 - c. Provide Push/Pull sets sized as shown in Hardware Headings.

K. Protective Plates:

1. Acceptable manufacturers:
 - a. Glynn Johnson
 - b. Ives
 - c. Rockwood Manufacturing*
2. Characteristics:
 - a. Provide manufacturers standard exposed fasteners for door trim units consisting of either machine screws or self-tapping screws.
 - b. Materials:
 - 1) Metal Plates: Bronze, .062 inch (U.S. 16 gage)

TECHNICAL SPECIFICATIONS FOR GLENDALE FIRE STATION
SECTION 08710 - DOOR HARDWARE

- c. Fabricate protection plates not more than 1-1/2 inches less than door width on hinge side and not more than 1/2 inch less than door width on pull side.
- d. Heights:
 - 1) Kick plates to be 10 inches in height.
 - 2) Armor plates to be 36 inches in height.

L. Thresholds:

- 1. Acceptable manufacturers:
 - a. National Guard Products, Inc.*
 - b. Reese Industries
 - c. Zero Weatherstripping Co., Inc.
- 2. Types: Indicated in Hardware Headings.

M. Weatherstripping:

- 3. Acceptable manufacturers:
 - a. National Guard Products, Inc.*
 - b. Reese Industries
 - c. Zero Weatherstripping Co., Inc.

Types: Indicated in Hardware Headings.

N. Silencers:

- 4. Acceptable manufacturers:
 - a. Glynn Johnson
 - b. Ives
 - c. Rockwood Manufacturing*
- 5. Three for each single doors; four for pairs of doors.

O. Door Seals:

- 1. Acceptable manufacturers:
 - a. National Guard Products, Inc.*
 - b. Reese Industries
 - c. Zero Weatherstripping Co., Inc.
- 2. Types: Indicated in Hardware Headings.

(Note: * Indicates manufacture for specified units in heading section).

2.02 MATERIALS AND FABRICATION

TECHNICAL SPECIFICATIONS FOR GLENDALE FIRE STATION
SECTION 08710 - DOOR HARDWARE

- A. Manufacturer's Name Plate: Do not use manufacturers' products that have manufacturer's name or trade name displayed in a visible location (omit removable nameplates) except in conjunction with required fire-rated labels and as otherwise acceptable to Architect.
 - 1. Manufacturer's identification will be permitted on rim of lock cylinders only.

- B. Base Metals: Produce hardware units of basic metal and forming method indicated, using manufacturer's standard metal alloy, composition, temper, and hardness, but in no case of lesser (commercially recognized) quality than specified for applicable hardware units by applicable ANSI/BHMA A156 series standards for each type of hardware item and with ANSI/BHMA A156.18 for finish designations indicated. Do not furnish "optional" materials or forming methods for those indicated, except as otherwise specified.

- C. Fasteners: Provide hardware manufactured to conform to published templates, generally prepared for machine screw installation.
 - 1. Do not provide hardware that has been prepared for self-tapping sheet metal screws, except as specifically indicated.
 - 2. Furnish screws for installation with each hardware item. Provide Phillips flat-head screws except as otherwise indicated. Finish exposed (exposed under any condition) screws to match hardware finish or, if exposed in surfaces of other work, to match finish of this other work as closely as possible including "prepared for paint" surfaces to receive painted finish.
 - 3. Provide concealed fasteners for hardware units that are exposed when door is closed except to the extent no standard units of type specified are available with concealed fasteners. Do not use thru-bolts for installation where bolt head or nut on opposite face is exposed in other work unless their use is the only means of adequately fastening the hardware. Coordinate with wood doors and metal doors and frames where thru-bolts are used as a means of reinforcing the work, provide sleeves for each thru-bolt or use sex screw fasteners.

2.03 HARDWARE FINISHES

- A. Match items to the manufacturer's standard color and texture finish for the latch and lock sets (or push-pull units if no latch or lock sets).

- B. Provide finishes that match those established by ANSI or, if none established, match the Architect's sample.

TECHNICAL SPECIFICATIONS FOR GLENDALE FIRE STATION
SECTION 08710 - DOOR HARDWARE

- C. Provide quality of finish, including thickness of plating or coating (if any), composition, hardness, and other qualities complying with manufacturer's standards, but in no case less than specified by referenced standards for the applicable units of hardware.
- D. Provide protective lacquer coating on all exposed hardware finishes of brass, bronze, and aluminum, except as otherwise indicated. The suffix "-NL" is used with standard finish designations to indicate "no lacquer."
- E. Finish to be US4(606) Satin Brass unless noted otherwise in the Hardware Schedule. Hinges and concealed door closers are to be plated to match. Surface mounted door closers are to be Powder Coat Paint to match.

PART 3 - EXECUTION

3.01 INSTALLATION

- A. Mount hardware units at heights indicated in following applicable publications, except as specifically indicated or required to comply with governing regulations and except as otherwise directed by Architect.
 - a. "Recommended Locations for Builders Hardware for Standard Steel Doors and Frames" by the Door and Hardware Institute.
 - b. NWWDA Industry Standard I.S.1.7, "Hardware Locations for Wood Flush Doors."
- B. Install each hardware item in compliance with the manufacturer's instructions and recommendations. Where cutting and fitting is required to install hardware onto or into surfaces that are later to be painted or finished in another way, coordinate removal, storage, and reinstallation or application of surface protection with finishing work specified in the Division 9 Sections. Do not install surface-mounted items until finishes have been completed on the substrates involved.
- C. Set units level, plumb, and true to line and location. Adjust and reinforce the attachment substrate as necessary for proper installation and operation.

Drill and countersink units that are not factory prepared for anchorage fasteners. Space fasteners and anchors in accordance with industry standards.
- D. Set thresholds for exterior doors in full bed of butyl-rubber or polyisobutylene mastic sealant complying with requirements specified in Division 7 Section "Joint Sealers."

TECHNICAL SPECIFICATIONS FOR GLENDALE FIRE STATION
SECTION 08710 - DOOR HARDWARE

- E. Weatherstripping and Seals: Comply with manufacturer's instructions and recommendations to the extent installation requirements are not otherwise indicated.

3.02 ADJUSTING, CLEANING, AND DEMONSTRATING

- A. Adjust and check each operating item of hardware and each door to ensure proper operation or function of every unit. Replace units that cannot be adjusted to operate freely and smoothly or as intended for the application made.
 - a. Where door hardware is installed more than one month prior to acceptance or occupancy of a space or area, return to the installation during the week prior to acceptance or occupancy and make final check and adjustment of all hardware items in such space or area. Clean operating items as necessary to restore proper function and finish of hardware and doors. Adjust door control devices to function properly with final operation of heating and ventilating equipment.
- B. Clean adjacent surfaces soiled by hardware installation.
- C. Door Hardware Supplier's Field Service
 - a. Inspect door hardware items for correct installation and adjustment after complete installation of door hardware.
 - b. Instruct Owner's personnel in the proper adjustment and maintenance of door hardware and hardware finishes.
 - c. File written report of this inspection to the Architect.
- D. Prior to project completion, a representative of the overhead closer manufacturer shall inspect and adjust all closers and certify that all closers are installed in accordance with the manufacturer's instructions, and are regulated properly and functioning correctly. A written report shall be provided to the Architect as to the inspection and shall include appropriate certificates.

END OF SECTION 08710

TECHNICAL SPECIFICATIONS FOR GLENDALE FIRE STATION
SECTION 09255 GYPSUM BOARD ASSEMBLIES

PART 1 - GENERAL

1.1 RELATED DOCUMENTS

- A. Drawings and general provisions of the Contract, including General and Supplementary Conditions and Division 1 Specification Sections, apply to this Section.

1.2 SUMMARY

- A. This Section includes the following:
 - 1. Non-load-bearing steel framing members for gypsum board assemblies.
 - 2. Gypsum board assemblies attached to steel framing.
 - 3. Cementitious Backer Units
- B. Related Sections: The following Sections contain requirements that relate to this Section:
 - 1. Division 5 Section "Cold-Formed Metal Framing" for load-bearing steel framing.

1.3 DEFINITIONS

- A. Gypsum Board Construction Terminology: Refer to ASTM C 11 and GA-505 for definitions of terms related to gypsum board assemblies not defined in this Section or in other referenced standards.

1.4 ASSEMBLY PERFORMANCE REQUIREMENTS

- A. Sound Transmission Characteristics: For gypsum board assemblies indicated to have STC ratings, provide materials and construction identical to those of assemblies whose STC ratings *were* determined per ASTM E 90, and classified per ASTM E 413 by a qualified independent testing agency.

1.5 SUBMITTALS

- A. General: Submit the following according to Conditions of the Contract and Division 1 Specification Sections.
 - 1. Product data for each type of product specified.
- B. Product certificates signed by manufacturers of gypsum board assembly components certifying that their products comply with specified requirements.

1.6 QUALITY ASSURANCE

- A. Fire-Test-Response Characteristics: Where fire-rated gypsum board assemblies are

TECHNICAL SPECIFICATIONS FOR GLENDALE FIRE STATION
SECTION 09255 GYPSUM BOARD ASSEMBLIES

indicated, provide materials and construction identical to those of assemblies tested for fire resistance per ASTM E 119 by an independent testing and inspecting agency acceptable to authorities having jurisdiction.

1. Fire Resistance Ratings; As indicated by reference to GA File Numbers in GA-600 "Fire Resistance Design Manual" or to design designations in IJL "Fire Resistance Directory" or in the listing of another testing and inspecting agency acceptable to authorities having jurisdiction.
- B. Single-Source Responsibility for Steel Framing: Obtain steel framing members for gypsum board assemblies from a single manufacturer.
- C. Single-Source Responsibility for Panel Products: Obtain each type of gypsum board and other panel products from a single manufacturer.
- D. Single-Source Responsibility for Finishing Materials: Obtain finishing materials from either the same manufacturer that supplies gypsum board and other panel products or from a manufacturer acceptable to gypsum board manufacturer.
- E. Field Samples: On actual gypsum board assemblies, prepare field samples of at least 100 sq. ft. in surface area for the following applications. Simulate finished lighting conditions for review of in-place unit of Work.
 1. Wall surfaces indicated to receive nontextured paint finishes,
 2. Ceiling surfaces indicated to receive nontextured paint finishes.

1.7 DELIVERY, STORAGE, AND HANDLING

- A. Deliver materials in original packages, containers, or bundles bearing brand name and identification of manufacturer or supplier.
- B. Store materials inside under cover and keep them dry and protected against damage from weather, direct sunlight, surface contamination, corrosion, construction traffic, and other causes. Neatly stack gypsum panels flat to prevent sagging.
- C. Handle gypsum board to prevent damage to edges, ends, and surfaces. Do not bend or otherwise damage metal corner beads and trim.

1.8 PROJECT CONDITIONS

- A. Environmental Conditions. General: Establish and maintain environmental conditions for applying and finishing gypsum board to comply with ASTM C 840 and with gypsum board manufacturer's recommendations.
- B. Room Temperatures: For nonadhesive attachment of gypsum board to framing,

TECHNICAL SPECIFICATIONS FOR GLENDALE FIRE STATION
SECTION 09255 GYPSUM BOARD ASSEMBLIES

maintain not less than 40 deg F (4 deg C). For adhesive attachment and finishing of gypsum board, maintain not less than 50 deg F (10 deg C) for 46 hours prior to application and continuously after until dry. Do not exceed 95 deg F (35 deg C) when using temporary heat sources.

- C. Ventilation: Ventilate building spaces, as required, for drying joint treatment materials. Avoid drafts during hot dry weather to prevent finishing materials from drying too rapidly.

PART 2 - PRODUCTS

2.1 MANUFACTURERS

- A. Manufacturers: Subject to compliance with requirements, provide products by one of the following:

Steel Framing and Furring:

Alabama Metal Industries Corp.
Gold Bond Building Products Div., National Gypsum Co.
USG, United States Gypsum Company

Grid Suspension Assemblies:

Chicago Metallic Corp,
National Rolling Mills
Co. USG Interiors, Inc.

Gypsum Board and Related Products:

Domtar Gypsum.
Georgia-Pacific Corp.
Gold Bond Building Products Div., National Gypsum
Co. United States Gypsum Co.

2.2 STEEL FRAMING COMPONENTS FOR SUSPENDED AND FURRED CEILING

- A. General: Provide components complying with ASTM C 754 for materials and sizes unless otherwise indicated.

1. Wire for Hangers and Ties: ASTM A 641, Class 1 zinc coating, soft temper.
2. Channels: Cold-rolled steel, 0.05980-inch-minimum thickness of base (uncoated) metal and 7116-inch-wide flanges, and as follows:
 - a. Carrying Channels: 2 inches deep, 590 lb per 1000 feet, unless otherwise indicated.
 - b. Furring Channels: 3/4 inch deep, 300 lb per 1000 feet, unless otherwise indicated.

TECHNICAL SPECIFICATIONS FOR GLENDALE FIRE STATION
SECTION 09255 GYPSUM BOARD ASSEMBLIES

- c. Finish: G-60 hot-dip galvanized coating per ASTM A 525 for framing for exterior soffits and where indicated.
- B. Steel Rigid Furring Channels: ASTM C 645, hat-shaped, depth of 7/16 inch, and minimum thickness of base (uncoated) metal as follows:
1. Thickness: 0.0329 inch, unless otherwise indicated.
 2. Protective Coating: G40 hot-dip galvanized coating per ASTM A 525

2.3 STEEL FRAMING FOR WALLS AND PARTITIONS

- A. General: Provide steel framing members complying with the following requirements:
1. Component Sizes and Spacings: As indicated but not less than that required to comply with ASTM C 754 under the following maximum deflection and lateral loading conditions:
 2. Maximum Deflection: U240 at 5 lbf per sq. ft.
 3. Protective Coating: G40 hot-dip galvanized coating per ASTM A 525.
- B. Steel Studs and *Runners*: ASTM C 645, with flange *edges of studs bent back 90 deg and* doubled over to form 3/16-inch-wide minimum lip (return) and complying with the following requirements for minimum thickness of base (uncoated) metal and for depth:
1. Thickness: 25 Gage unless noted otherwise.
 2. Depth: 3-5/8 inches, unless otherwise indicated.
- C. Steel Rigid Furring Channels: ASTM C 645, hat-shaped, depth and minimum thickness of base (uncoated) metal as follows:
1. Depth: 7/8 inch.
 2. Thickness: 0.0179 inch, unless otherwise indicated.
- D. Fasteners for Metal Framing: Provide fasteners of type, material, size, corrosion resistance, holding power, and other properties required to fasten steel framing and furring members securely to substrates involved; complying with the recommendations of gypsum board manufacturers for applications indicated,

2.4 GYPSUM BOARD PRODUCTS

- A. General: Provide gypsum board of types indicated in maximum lengths available to minimize end-to-end butt joints.

TECHNICAL SPECIFICATIONS FOR GLENDALE FIRE STATION
SECTION 09255 GYPSUM BOARD ASSEMBLIES

1. Thickness: Provide gypsum board in thicknesses indicated or, if not otherwise indicated, in 5/8 inch thicknesses to comply with ASTM C 840 for application system and support spacing indicated.

B. Gypsum Wallboard: ASTM C 36 and as follows:

Type: Regular for vertical surfaces, unless otherwise indicated.
Type: Type X where required for fire-resistive-rated assemblies.

Type: Sag-resistant type for ceiling surfaces.

Type: Paperless mold-resistant for bathrooms

Edges: Tapered.

Thickness: 5/8 inch where indicated.

C. Products: Subject to compliance with requirements, provide one of the following products where proprietary gypsum wallboard is indicated.

Firestop Type C, Georgia-Pacific Corp.

Fire-Shield G, Gold Bond Building Products Div., National Gypsum Co.

SHEETROCK Brand Gypsum Panels, FIRECODE C Core, United States Gypsum

D. Exterior Gypsum Soffit Board: ASTM C 931, with manufacturer's standard edges, of type and thickness indicated below:

Type: Regular, unless otherwise indicated.

Thickness: 5/8 inch, unless otherwise indicated.

2.5 CEMENTITIOUS BACKER UNITS

A. Provide cementitious backer units complying with ANSI A 118.9, of thickness and width indicated below, and in maximum lengths available to minimize end-to-end butt joints.

1. Thickness: 5/8 inch, unless otherwise indicated.
2. Width: Manufacturer's standard width but not less than 32 inches.
3. Products: Subject to, compliance with requirements, provide one of the following products:

DomCrete Cementitious Tile-Backer board, Domtar Gypsum.

TECHNICAL SPECIFICATIONS FOR GLENDALE FIRE STATION
SECTION 09255 GYPSUM BOARD ASSEMBLIES

Glass-crete Cementitious Backer Board, Glascrete, Inc.

DUROCK Interior Cement Board, United States Gypsum Co.

2.6 TRIM ACCESSORIES

- A. Accessories for Interior Installation: Comer beads, edge trim, and control joints complying with ASTM C 1047 and requirements indicated below:
1. Material: Formed metal complying with the following requirement:
Sheet steel zinc-coated by hot-dip process.
 2. Shapes indicated below by reference to Fig. 1 designations in ASTM C 1047: Cornerbead on outside comers, unless otherwise indicated.

L-bead with face flange only; face flange formed to receive joint compound. Use L-bead where indicated.

U-bead with face and back flanges; face flange formed to be left without application of joint compound. Use U-bead where indicated.
- B. Zinc Accessories for Exterior Ceilings: Comer beads, edge trim, and control joints formed from rolled zinc complying with ASTM C 1047, in shapes indicated below by reference to ASTM C 1047:
1. Comer bead on outside corners, unless otherwise indicated.
 2. Edge trim complying with ASTM C 1047, formed from rolled zinc, shape LC-Bead per Fig. 1, unless otherwise indicated.
- C. Linear Soffit Vent: Provide 2" linear soffit vent as indicated below:
1. Manufacturer. Fry Reglet, Model 16B0Y

2.7 JOINT TREATMENT MATERIALS

- A. General: Provide joint treatment materials complying with ASTM C 475 and the recommendations of both the manufacturers of sheet products and of joint treatment materials for each application indicated.
1. Joint Tape for Gypsum Board: Paper reinforcing tape, unless otherwise indicated.
 2. Joint Tape for Cementitious Backer Units: Polymer-coated open glass-fiber

TECHNICAL SPECIFICATIONS FOR GLENDALE FIRE STATION
SECTION 09255 GYPSUM BOARD ASSEMBLIES

- mesh.
3. Drying-Type Joint Compounds for Gypsum Board: Factory-packaged vinyl-based products complying with the following requirements for formulation and intended use.
 - a. Ready-Mixed Formulation: Factory-mixed product.
 - b. Taping compound formulated for embedding tape and for first coat over fasteners and face flanges of trim accessories.
 - c. Topping compound formulated for fill (second) and finish (third) coats. All-purpose compound formulated for both taping and topping compounds.

B. Joint Compound for Cementitious Backer Unit:- Material recommended by cementitious backer unit manufacturer.

C. ACOUSTICAL SEALANT

1. Latex Acoustical Sealant: Manufacturer's standard nonsag paintable, nonstaining latex sealant complying with ASTM C 834 and the following requirements:
2. Product is effective in reducing airborne sound transmission through perimeter joints and openings in building construction as demonstrated by testing representative assemblies per ASTM E 90.

2.8 MISCELLANEOUS MATERIALS

- A. General: Provide auxiliary materials for gypsum board construction that comply with referenced standards and recommendations of gypsum board manufacturer.
- B. Fastening Adhesive for Masonry: Special adhesive recommended for fastening gypsum panels to masonry.
- C. Steel drill screws complying with ASTM C 1002 for the following applications:
 1. Fastening gypsum board to steel members less than 0.03 inch thick.
 1. Fastening gypsum board to gypsum board.
- D. Steel drill screws complying with ASTM C 954 for fastening gypsum board to steel members from .033 to 0.112 inch thick.

TECHNICAL SPECIFICATIONS FOR GLENDALE FIRE STATION
SECTION 09255 GYPSUM BOARD ASSEMBLIES

- E. Corrosion-resistant-coated steel drill screws of size and type recommended by board manufacturer for fastening cementitious backer units.
- F. Sound Attenuation Blankets: Unlaced mineral-fiber blanket insulation produced by combining mineral fibers of type described below with thermosetting resins to comply with ASTM C 665 for Type I (blankets without membrane facing):
 - 1. Mineral-Fiber Type: Fibers manufactured from glass or slag.

PART 3 - EXECUTION

3.1 EXAMINATION

- A. Examine substrates to which gypsum board assemblies attach or abut, installed hollow metal frames, cast-in-anchors, and structural framing with installer present for compliance with requirements for installation tolerances and other conditions affecting performance of assemblies specified in this Section. Do not proceed with installation until unsatisfactory conditions have been corrected.

3.2 PREPARATION

- A. Ceiling Anchorages: Coordinate installation of ceiling suspension systems with installation of overhead structural assemblies to ensure that inserts and other provisions for anchorages to building structure have been installed to receive ceiling hangers that will develop their full strength and at spacing required to support ceilings.

3.3 INSTALLING STEEL FRAMING, GENERAL

- A. Steel Framing Installation Standard: Install steel framing to comply with ASTM C 754 and with ASTM C 840 requirements that apply to framing installation.

assemblies to support fixtures, equipment services, heavy trim, grab bars, toilet accessories, furnishings, or similar construction. Comply with details indicated and with recommendations of gypsum board manufacturer or, if none available, with "Gypsum Construction Handbook" published by United States Gypsum Co.
- C. Isolate steel framing from building structure at locations indicated to prevent transfer of loading imposed by structural movement, Comply with details shown on Drawings.
 - 1. Where building structure abuts ceiling perimeter or penetrates ceiling.
 - 2. Where partition framing and wall furring abut structure except at floor.
 - a. Provide slip or cushioned-type joints as detailed to attain lateral support and avoid axial loading.

TECHNICAL SPECIFICATIONS FOR GLENDALE FIRE STATION
SECTION 09255 GYPSUM BOARD ASSEMBLIES

- D. Do not bridge building expansion and control joints with steel framing or furring members. Independently frame both sides of joints with framing or furring members as indicated.

3.4 INSTALLING STEEL FRAMING FOR SUSPENDED AND FURRED CEILINGS

- A. Suspend ceiling hangers from building structural members and as follows:
 - 1. Install hangers plumb and free from contact with insulation or other objects within ceiling plenum that are not part of supporting structural or ceiling suspension system. Splay hangers only where required to miss obstructions and offset resulting horizontal forces by bracing, countersplaying, or other equally effective means.
 - 2. Where width of ducts and other construction within ceiling plenum produces hanger spacings that interfere with the location of hangers required to support standard suspension system members, install supplemental suspension members and hangers in form of trapezes or equivalent devices, Size supplemental suspension members and hangers to support ceiling loads within performance limits established by referenced standards.
- B. Secure wire hangers by looping and wire-tying, either directly to structures or to inserts, eyescrews, or other devices and fasteners that are secure and appropriate for substrate, and in a manner that will not cause them to deteriorate or otherwise fail due to age, corrosion, or elevated temperatures.
 - 1. Do not attach hangers to steel deck tabs.
 - 2. Do not attach hangers to steel roof deck. Attach hangers to structural members. Do not connect or suspend steel framing from ducts, pipes or conduit.
- C. Sway-brace suspended steel framing with hangers used for support.
- D. Install suspended steel framing components in sizes and at spacings indicated but not less than that required by the referenced steel framing installation standard.
 - 1. Wire Hangers: 0.1620-inch (8-gage) diameter, 4 feet o.c.
 - 2. Carrying Channels (Main Runners): 2 inch, 4 feet o.c.
 - 3. Rigid Furring Channels (Furring Members): 16 inches o.c.
- E. Installation Tolerances: Install steel framing components for suspended ceilings so that

TECHNICAL SPECIFICATIONS FOR GLENDALE FIRE STATION
SECTION 09255 GYPSUM BOARD ASSEMBLIES

cross-furring members or grid suspension members are level to within 1/8 inch in 12 feet as measured both lengthwise on each member and transversely between parallel members.

- F. Wire-tie or clip furring members to main runners and to other structural supports as indicated.
- G. Grid Suspension System: Attach perimeter wall track or angle where grid suspension system meets vertical surfaces. Mechanically join main beam and cross-furring members to each other and butt-cut to fit into wall track.
- H. For exterior soffits, install cross-bracing and additional framing to resist wind.

3.5 INSTALLING STEEL FRAMING FOR WALLS AND PARTITIONS

- A. Install runners (tracks) at floors, ceilings, and structural walls and columns where gypsum board stud assemblies abut other construction.
 - 1. Where studs are installed directly against exterior walls, install asphalt felt strips between studs and wall.
- B. Installation Tolerances: Install each steel framing and furring member so that fastening surfaces do not vary more than 1/8 inch from the plane formed by the faces of adjacent framing.
- C. Extend partition framing full height to structural supports or substrates above suspended ceilings, except where partitions are indicated to terminate at suspended ceilings. Cut studs 1/2 inch short of full height. Continue framing over frames for doors and openings and frame around ducts penetrating partitions above ceiling to provide support for gypsum board.
 - 1. For STC-rated and fire-resistive-rated partitions requiring partitions to extend to the underside of floor/roof slabs and decks or other continuous solid structural surfaces to obtain ratings, install framing around structural and other members extending below floor/roof slabs and decks, as needed to support gypsum board closures needed to make partitions continuous from floor to underside of solid structure.
- D. Install steel studs and furring in sizes and at spacings indicated but not less than that required by *the referenced steel framing installation standard to comply with maximum* deflection and minimum loading requirements specified:
 - 1. Single-Layer Construction: Space studs at 24 inches o.c. unless indicated otherwise.

TECHNICAL SPECIFICATIONS FOR GLENDALE FIRE STATION
SECTION 09255 GYPSUM BOARD ASSEMBLIES

- E. Install steel studs so that flanges point in the same direction and so that leading edges or ends of each gypsum board can be attached to open (unsupported) edges of stud flanges first.
- F. Frame door openings to comply with details indicated, with GA-219, and with applicable published recommendations of gypsum board manufacturer. Attach vertical studs at jambs with screws either directly to frames or to jamb anchor clips on door frames; install runner track section (for cripple studs) at head and secure to jamb studs.
 - 1. Extend vertical jamb studs through suspended ceilings and attach to underside of floor or roof structure above.
- G. Frame openings other than door openings to comply with details indicated or, if none indicated, in same manner as required for door openings. Install framing below sills of openings to match framing required above door heads.
- H. Install sound attenuation insulation as follows:
 - 1. Erect insulation vertically and hold in place with Z-furring members spaced 24 inches o.c.
 - 2. Except at exterior comers, securely attach narrow flanges of furring members to wall with concrete stub nails, screws designed for masonry attachment, or powder-driven fasteners spaced 24 inches o.c.
 - 3. At exterior comers; attach wide flange of furring members to wall with short flange extending beyond comer; on adjacent wall surface, screw attach short flange of furring channel to web of attached channel. Start from this furringchannel with standard width insulation panel and continue in regular manner. At interior comers, space second member no more than 12 inches from comer andcut insulation to fit.

3,6 APPLYING AND FINISHING GYPSUM BOARD, GENERAL

- A. Gypsum Board Application and Finishing Standards: Install and finish gypsum panels to comply with ASTM C 840 and GA-216.
- B. Install sound attenuation blankets where indicated prior to installing gypsum panels unless blankets are readily installed after panels have been installed on one side.
- C. Install ceiling board panels across framing to minimize the number of abutting end joints and avoid abutting end joints in the central area *of* each ceiling. Stagger abutting end joints of adjacent panels not less than one framing member.

TECHNICAL SPECIFICATIONS FOR GLENDALE FIRE STATION
SECTION 09255 GYPSUM BOARD ASSEMBLIES

- D. Install wall/partition board panels to minimize the number of abutting end joints or avoid them entirely. Stagger abutting end joints not less than one framing member in alternate courses *of* board. At stairwells and other high walls, install panels horizontally with end abutting joints over studs and staggered.
- E. Install gypsum panels with face side out, Do not install imperfect, damaged, or damp panels. Butt panels together for a light contact at edges and ends with not more than 1/16 inch of open space between panels. Do not force into place.
- F. Locate both edge or end joints over supports, except in ceiling applications where intermediate supports or gypsum board back-blocking is provided behind end joints. Position adjoining panels so that tapered edges abut tapered edges, and field-cut edges abut field-cut edges and ends. Do not place tapered edges against cut edges or ends. Stagger vertical joints over different studs on opposite sides *of* partitions. Avoid joints at corners of framed openings where possible.
- G. Attach gypsum panels to steel studs so that the leading edge or end *of* each panel is attached to open (unsupported) edges of stud flanges first.
- H. Attach gypsum panels to framing provided at openings and cutouts.
 - 1. Form control joints and expansion joints at locations indicated and as detailed, with space between edges of adjoining gypsum panels, as well as supporting framing behind gypsum panels.
- J. Cover both faces *of* steel stud partition framing with gypsum panels in concealed spaces (*above ceilings, etc.*), *except in chase walls that are braced internally.*
 - 1. Except where concealed application is indicated or required for sound, fire, air, or smoke ratings, coverage may be accomplished with scraps of not less than 8 sq. ft. in area.
 - 2. Fit gypsum panels around ducts, pipes, and conduits.
- K. Isolate perimeter *of* non-load-bearing gypsum board partitions at structural abutments, except floors, as detailed. Provide 1/4-inch-to-1/2-inch-wide spaces at these locations and trim edges with U-bead edge trim where edges *of* gypsum panels are exposed. Seal joints between edges and abutting structural surfaces with acoustical sealant.
- L. Where STC-rated gypsum board assemblies are indicated, seal construction at perimeters, behind control and expansion joints, openings, and penetrations with a continuous bead of acoustical sealant including a bead at both faces *of* the partitions. Comply with ASTM C 919 and manufacturer's recommendations for location of edge trim and closing off sound-flanking paths around or through gypsum board assemblies, including sealing partitions above acoustical ceilings.

TECHNICAL SPECIFICATIONS FOR GLENDALE FIRE STATION
SECTION 09255 GYPSUM BOARD ASSEMBLIES

- M. Space fasteners in gypsum panels according to referenced gypsum board application and finishing standard and manufacturer's recommendations.

3.7 GYPSUM BOARD APPLICATION METHODS

- A. Single-Layer Application: Install gypsum Wallboard panels as follows:
 - 1. On ceilings, apply gypsum panels prior to wall partition board application to the greatest - extent possible and -at right angles to framing, unless otherwise indicated.
 - 2. On partitions/walls, apply gypsum panels horizontally (perpendicular to framing), unless parallel application is required for fire-resistive-rated assemblies. Use maximum-length panels to minimize end joints.

- B. Wall Tile Substrates: For substrates indicated to receive thin-set ceramic tile and similar rigid applied wall finishes, comply with the following:
 - 1. Install cementitious backer units as ceramic tile substrate to comply with ANSI A 108.11.
 - 2. Single-Layer Fastening Methods: Apply gypsum panels to supports as follows:
 - a. Fasten with screws.

- C. Exterior Soffits and Ceilings: Apply exterior gypsum soffit board panels perpendicular to supports, with end joints staggered over supports. Install with 1/4-inch open space where panels abut other construction or structural penetrations.
 - 1. Fasten with corrosion resistant screws.

3.8 INSTALLING TRIM ACCESSORIES

- A. General: For trim accessories with back flanges, fasten to framing with the same fasteners used to fasten gypsum board. Otherwise, fasten trim accessories according to accessory manufacturer's directions for type, length, and spacing of fasteners.
 - 1. Install corner beads at external corners.
 - 2. Install edge trim where edge of gypsum panels would otherwise be exposed or semiexposed. Provide edge trim type with face flange formed to receive joint compound except where other types are indicated.
 - a. Install L-bead where edge trims can only be installed after gypsum

TECHNICAL SPECIFICATIONS FOR GLENDALE FIRE STATION
SECTION 09255 GYPSUM BOARD ASSEMBLIES

panels are installed.

- b. Install U-bead where indicated.
 - c. Install aluminum edge trim and other accessories where indicated.
- B. Install control joints at locations indicated, and where not indicated according to ASTM C 840, and in locations approved by Architect for visual effect.

3.9 FINISHING GYPSUM BOARD ASSEMBLIES

- A. General: Apply joint treatment at gypsum board joints (both directions); flanges of corner bead, edge trim, and control joints; penetrations; fastener heads; surface defects, and elsewhere as required to prepare gypsum board surfaces for decoration and levels of gypsum board finish indicated.
- B. P refill open joints, rounded or beveled edges, and damaged areas using setting-type joint compound.
- C. Apply joint tape over gypsum board joints except those with trim accessories having concealed face flanges not requiring taping to prevent cracks from developing in joint treatment at flange edges.
- D. Levels of Gypsum Board Finish: Provide the following levels of gypsum board finish per GA-214.
- 1. Level 1 for ceiling plenum areas, concealed areas, and where indicated, unless a higher level of finish is required for fire-resistive-rated assemblies and sound-rated assemblies.
 - 2. Level 4 for gypsum board surfaces indicated to receive gloss and semigloss enamels, nontextured flat paints, and where indicated.
- E. For level 4 gypsum board finish, embed tape in finishing compound plus two separate coats applied over joints, angles, fastener heads, and trim accessories using one of the following combinations of joint compounds (not including prefill), and sand between coats and after last coat.
- 1. Embedding and First Coat: Ready-mixed, drying type, all-purpose or taping compound. Fill (Second) Coat: Ready-mixed, drying-type, all-purpose or topping compound. Finish (Third) Coat: Ready-mixed, drying-type, all-purpose or topping compound.
- F. Where level 4 gypsum board finish is indicated, apply joint compound combination specified for level 4 plus a thin, uniform skim coat of joint compound over entire surface. Use joint compound specified for the finish (third coat) or a product

TECHNICAL SPECIFICATIONS FOR GLENDALE FIRE STATION
SECTION 09255 GYPSUM BOARD ASSEMBLIES

specially formulated for this purpose and acceptable to gypsum board manufacturer. Produce surfaces free of tool marks and ridges ready for decoration of type indicated.

- G. Finish exterior gypsum soffit board using setting-type joint compounds to prefill joints and embed tape, and for first, fill (second) and finish (third) coats, with the last coat being a sand able product. Smooth each coat before joint compound hardens to minimize need for sanding. Sand between coats and after finish coat.
 - 1. Painting exterior gypsum soffitboard after finish coat has dried is specified in Division 9 Section "Painting"
- H. Finish cementitious backer units to comply with unit manufacturer's directions.

4.0 CLEANING AND PROTECTION

- A. Promptly remove any residual joint compound from adjacent surfaces.
- B. Provide final protection and maintain conditions, in a manner suitable to Installer that ensures gypsum board assemblies remain without damage or deterioration at time of Substantial Completion.

END OF SECTION 09255

TECHNICAL SPECIFICATIONS FOR GLENDALE FIRE STATION

SECTION 09310 - CERAMIC TILE

PART 1 - GENERAL

1.1 RELATED DOCUMENTS

- A. Drawings and general provisions of the Contract, including General and Supplementary Conditions and Division 1 Specification Sections, apply to this Section.

1.2 SUMMARY

- A. This Section includes the following:

Ceramic mosaic tile.

Ceramic porcelain tile.

Glazed wall tile.

Stone thresholds installed as part of tile installations.

- B. Related Sections include the following:

- 1. Division 9 Section "Gypsum Board Assemblies" for cementitious backer units installed in gypsum wallboard assemblies.

1.3 DEFINITIONS

- A. Module Size: Actual tile size (minor facial dimension as measured per ASTM C 499) plus joint width indicated.
- B. Facial Dimension: Actual tile size (minor facial dimension as measured per ASTM C 499).
- C. Facial Dimension: Nominal tile size as defined in ANSI A137.1.

1.4 SUBMITTALS

- A. Product Data: For each type of tile, mortar, grout, and other products specified.
 - 1. Shoe Drawings: For the following:
 - a. Tile patterns and locations.
- B. Tile Samples for Initial Selection: Manufacturer's color charts consisting of actual tiles or sections of tiles showing the full range of colors, textures, and patterns

TECHNICAL SPECIFICATIONS FOR GLENDALE FIRE STATION

SECTION 09310 - CERAMIC TILE

- available for each type and composition of tile indicated. Include Samples of accessories involving color selection.
- C. Grout Samples for Initial Selection: Manufacturer's color charts consisting of actual sections of grout showing the full range of colors available for each type of grout indicated.
- D. Samples for Verification: Of each item listed below, prepared on Samples of size and construction indicated. Where products involve normal color and texture variations, include Sample sets showing the full range of variations expected.
1. Each type and composition of tile and for each color and texture required, at least 12 inches (300 mm) square, mounted on plywood or hardboard backing, and with grouted joints using product complying with specified requirements and approved for completed work in color or selected by the Architect.
 2. Full-size units of each type of trim and accessory for each color required.
 3. Stone thresholds in 6-inch (150-mm) lengths.
- E. Qualification Data: For firms and persons specified in the "Quality Assurance" Article to demonstrate their capabilities and experience. Include lists of completed projects with project names and addresses, names of architects and owners, and other information specified.

1.5 QUALITY ASSURANCE

- A. Installer Qualifications: Engage an experienced installer who has completed tile installations similar in material, design, and extent to that indicated for this Project and with a record of successful in-service performance.
- B. Source Limitations for Tile: Obtain each color, grade, finish, type, composition, and variety of tile from one source with resources to provide products from the same production run for each contiguous area of consistent quality in appearance and physical properties without delaying the Work.
- C. Source Limitations for Setting and Grouting Materials: Obtain ingredients of a uniform quality for each mortar, adhesive, and grout component from a single manufacturer and each aggregate from one source or producer.
- D. Source Limitations for Other Products: Obtain each of the following products specified in this Section from one source and by a single manufacturer for each product:

Stone thresholds.

TECHNICAL SPECIFICATIONS FOR GLENDALE FIRE STATION

SECTION 09310 - CERAMIC TILE

1.6 DELIVERY, STORAGE. AND HANDLING

- A. Deliver and store packaged materials in original' containers with seals unbroken and labels intact until time of use. Comply with requirement of ANSI A137.1 for labeling sealed tile packages.
- B. Prevent damage or contamination to materials by water, freezing, foreign matter, and other causes.

1.7 PROJECT CONDITIONS

- A. Environmental Limitations: Do not install tile until construction in spaces is completed and ambient temperature and humidity conditions are being maintained to comply with referenced standards and manufacturer's written instructions.

1.8 EXTRA MATERIALS

- A. Deliver extra materials to Owner. Furnish extra materials described below that match products installed, are packaged with protective covering for storage, and are identified' with labels describing contents.
 - 1. Tile and Trim Units: Furnish quantity of full-size units equal to 3 percent of amount installed, for each type, composition, color, pattern, and size indicated.

PART 2 - PRODUCTS

2.1 MANUFACTURERS

- A. Products: Subject to compliance with requirements, provide products indicated on the drawings.
- B. Manufacturers: Provide products as specified on the drawings.

2.2 PRODUCTS-GENERAL

- A. ANSI Ceramic Tile Standard: Provide tile that complies with ANSI A 137.1, "Specifications for Ceramic Tile," for types, compositions, and other characteristics indicated.
 - 1. Provide tile complying with Standard Grade requirements, unless otherwise indicated.
- B. ANSI Standards for Tile Installation Materials: Provide materials complying with ANSI standards referenced in "Setting Materials" and "Grouting Materials" articles.

TECHNICAL SPECIFICATIONS FOR GLENDALE FIRE STATION

SECTION 09310 - CERAMIC TILE

- C. Colors, Textures, and Patterns: Where manufacturer's standard products are indicated for tile, grout, and other products requiring selection of colors, surface textures, patterns, and other appearance characteristics, provide specific products or materials complying with the following requirements:
1. Provide tile trim and accessories that match color and finish of adjoining flat tile.

2.3 TILE PRODUCTS

- A. Unglazed Ceramic Mosaic Tile (CT-3): Provide factory-mounted flat tile complying with the following requirements:

Composition: Porcelain.

Module Size: 2 by 2 inches (50.8 by 50.8 mm).

Nominal Thickness: 1/4 inch (6.35 mm).

Face: Plain with cushion edges.

- B. Unglazed Ceramic Tile (CT-1, CT-2): Provide factory mounted fiat tile complying with the following requirements:

Composition: Porcelain

Module Size: As indicated on drawings.

Face: Plain with cushion edges.

Pattern: As indicated on the drawings. Note that two ceramic tile colors will be used.

- C. Glazed Wall Tile (CT-3): Provide flat tile complying with the following requirements:

Module Size: 8" x 8"

Thickness: 5/16 inch (8 mm).

Face: Plain with cushion edges.

Mounting: Factory back-mounted.

- D. Trim Units: Provide tile trim units to match characteristics of adjoining flat tile and to comply with the following requirements:

TECHNICAL SPECIFICATIONS FOR GLENDALE FIRE STATION

SECTION 09310 - CERAMIC TILE

1. Size: As indicated, coordinated with sizes and coursing of adjoining flat tile where applicable.
2. Shapes: As follows, selected from manufacturer's standard shapes:
 - a. Base for Thin-Set Mortar Installations: Straight.
 - b. Wainscot Call for Thin-Set Mortar Installations: Surface bullnose.
 - c. External Comers for Thin-Set Mortar Installations: Surface bullnose.
 - d. Internal Comers: Field-buttet square corners, except with coved base and cap angle pieces designed to member with stretcher shapes.

2.4 STONE THRESHOLDS

- A. General: Provide stone thresholds that are uniform in color and finish, fabricated to sizes and profiles indicated to provide transition between tile surfaces and adjoining finished floor surfaces.
- B. Marble Thresholds: Provide marble thresholds complying with ASTM C 503 requirements for exterior use and with a minimum abrasive-hardness value of 10 per ASTM C 241.
 1. Provide white, honed marble complying with the Marble Institute of America's Group A requirements for soundness.

2.5 SETTING MATERIALS.

- A. Latex Portland Cement Mortar: ANSI A 118.4, composition: as follows:
- B. Prepackaged dry mortar mix composed of portland cement, graded aggregate, and the following dry polymer additive in the form of a reemulsifiable powder to which only water is added at the job site.
 1. Dry Polymer Additive: Manufacturer's standard.
 2. Latex Additive: (water emulsion) of type described below, serving as replacement for part or all of gauging water, combined at the job site with prepackaged dry mortar mix supplied or specified by latex additive manufacturer.
 3. Latex Type: Manufacturer's standard.

TECHNICAL SPECIFICATIONS FOR GLENDALE FIRE STATION

SECTION 09310 - CERAMIC TILE

2.6 GROUTING MATERIALS

- A. Latex-Portland Cement Grout: ANSI A 118.6, color as indicated, composition as follows:
- B. Prepackaged dry grout mix composed of portland cement, graded aggregate, and the following dry polymer additive in the form of a reemulsified powder to which only water is added at the job site.
 - 1. Dry Polymer Additive: Manufacturer's standard.
 - 2. Latex Additive: (water emulsion) serving as replacement for part or all of the gauging water, added at job site with dry grout mixture, with type of latex and dry grout mix as follows:
 - a. Latex Type: Acrylic Resin.
 - b. Dry Grout Mixture: Commercial portland cement specified or supplied by latex additive manufacturer.

2.7 MISCELLANEOUS MATERIALS

- A. Metal Edge Strips: White-zinc-alloy terrazzo strips, 1/8 inch (3.2 mm) wide at top edge with integral provision for anchorage to mortar bed or substrate, unless otherwise indicated.
- B. Temporary Protective Coating: Provide product indicated below that is formulated to protect exposed surfaces of tile against adherence of mortar and grout; is compatible with tile, mortar, and grout products; and is easily removable after grouting is Completed without damaging grout or tile.
 - 1. Grout release in form of manufacturer's standard proprietary liquid coating that is specially formulated and recommended for use as a temporary protective coating for tile.
- C. Tile Cleaner: A. neutral cleaner capable of removing soil and residue without harming the and grout surfaces, specifically approved for materials and installations indicated by tile and grout manufacturers.

2.8 MIXING MORTARS AND GROUT

- A. Mix mortars and grouts to comply with referenced standards and mortar and grout manufacturers' written instructions.
- B. Add materials, water, and additives in accurate proportions.
- C. Obtain and use type of mixing equipment, mixer speeds, mixing containers,

TECHNICAL SPECIFICATIONS FOR GLENDALE FIRE STATION

SECTION 09310 - CERAMIC TILE

mixing time, and other procedures to produce mortars and grouts of uniform quality with optimum performance, characteristics for installations indicated.

PART 3 - EXECUTION

3.1 EXAMINATION

- A. Examine substrates areas and conditions where tile will be installed, with Installer present, for compliance with requirements for installation tolerances and other conditions affecting performance of installed tile.
 - 1. Verify that substrates for setting tile are firm; dry; clean; free from oil, waxy films, and curing compounds; and within flatness tolerances required by referenced ANSI A 108 series of tile installation standards for installations indicated.
 - 2. Verify that installation of grounds, anchors, recessed frames, electrical and mechanical units of work, and similar items located in or behind tile has been completed before installing tile.
 - 3. Verify that joints and cracks in tile substrates are coordinated with tile joint locations; if not coordinated, adjust latter in consultation with Architect.
- B. Do not proceed with installation until unsatisfactory conditions have been corrected.

3.2 PREPARATION

- A. Provide concrete substrates for tile floors installed with dry-set or latex-portland cement mortars that comply with flatness tolerances specified in referenced ANSI A 108 series of tile installation standards for installations indicated.
- B. Blending: For tile exhibiting color variations within the ranges selected during Sample submittals, verify that tile has been blended in the factory and packaged so tile units taken from one package show the same range in colors as those taken from other packages and match approved Samples. If not factory blended, either return to manufacturer or blend tiles at Project site before installing.
- C. Field-Applied Temporary Protective Coating: Where indicated under tile type or needed to prevent adhesion or staining of exposed tile surfaces by grout, protect exposed surfaces of tile against adherence of mortar and grout by precoating them with a continuous film of temporary protective coating indicated below, taking care not to coat unexposed tile surfaces: Grout release.

3.3 INSTALLATION, GENERAL

TECHNICAL SPECIFICATIONS FOR GLENDALE FIRE STATION

SECTION 09310 - CERAMIC TILE

- A. ANSI Tile Installation Standards: Comply with parts of ANSI A108 series of tile installation standards in "Specifications for Installation of Ceramic Tile" that apply to types of setting and grouting materials and to methods indicated in ceramic tile installation schedules.
- B. TCA Installation Guidelines: TCA's "Handbook for Ceramic Tile Installation. It Comply with TCA installation methods indicated in ceramic tile installation schedules.
- C. Extend tile work into recesses and under or behind equipment and fixtures to form a complete covering without interruptions, unless otherwise indicated.
Terminate work neatly at obstructions, edges, and comers without disrupting pattern or joint alignments.
- D. Accurately form intersections and returns. Perform cutting and drilling of tile without marring visible surfaces. Carefully grind cut edges of tile abutting trim, finish, or built-in items for straight aligned joints. Fit tile closely to electrical outlets, piping, fixtures, and other penetrations so plates, collars, or covers overlap tile.
- E. Jointing Pattern: Lay tile in grid pattern, unless otherwise indicated. Align joints when adjoining tiles on floor, base, walls, and trim are the same size. Layout tile work and center tile fields in both directions in each space or on each wall area. Adjust to minimize tile cutting. Provide uniform joint widths, unless otherwise indicated.
 - 1. For tile mounted in sheets, make joints between tile sheets the same width as joints within tile sheets so joints between sheets are not apparent in finished work.
- F. Lay out tile wainscots to next full tile beyond dimensions indicated.
- G. Expansion Joints: Locate expansion joints and other sealant-filled joints, including control, contraction, and isolation joints, where indicated during installation of setting materials, mortar beds, and tile. Do not saw-cut joints after installing tiles.
 - 1. Locate joints in tile surfaces directly above joints in concrete substrates.
 - 2. Prepare joints and apply sealants to comply with requirements of Division 7 Section "Joint Sealants".
- H. Grout tile to comply with the requirements of the following tile installation standards:
 - 1. For ceramic tile grouts (sand-portland cement, dry-set. commercial portland cement, and latex-portland cement grouts), comply with ANSI A108.10.

TECHNICAL SPECIFICATIONS FOR GLENDALE FIRE STATION

SECTION 09310 - CERAMIC TILE

- G. At showers tubs, and other wet locations, install cementitious backer units and treat joints to comply with ANSI A 108.11 and manufacturer's written instructions for type of application indicated.

3.4 FLOOR TILE INSTALLATION

- A. General: Install tile to comply with requirements in the Ceramic Tile Floor Installation Schedule, including those referencing TCA installation methods and ANSI A 108 series of tile installation standards.
- B. Joint Widths: Install tile on floors with the following joint widths:
 - Ceramic Mosaic Tile: 1/16 inch (1.6mm).
 - Ceramic Porcelain Tile: per manufacturer's standards.
- C. Back Buttering: For installations indicated, obtain 100 percent mortar coverage by complying with applicable special requirements for back buttering of tile in referenced ANSI A 108 series of tile installation standards:
 - 1. Tile floors in wet areas, including showers, tub enclosures, laundries, and swimming pools.
- D. Stone Thresholds: Install stone thresholds at locations indicated; set in same type of setting bed as abutting field tile, unless otherwise indicated.
 - 1. Set thresholds in latex-portland cement mortar for locations where mortar bed would otherwise be exposed above adjacent nontile floor finish.
 - 2. Metal Edge Strips: Install at locations indicated or where exposed edge of tile flooring meets carpet, wood, or other flooring that finishes flush with top of tile.

3.5 WALL TILE INSTALLATION

- A. Install types of tile designated for wall installations to comply with requirements in the Ceramic Tile Wall Installation Schedule, including those referencing TCA installation methods and ANSI setting-bed standards.
- B. Joint Widths: Install tile on walls with the following joint widths:
 - Wall Tile: 1/16 inch (1.6 mm).
- C. Back Buttering: For installations indicated, obtain 100 percent mortar coverage by complying with applicable special requirements for back buttering of tile in referenced ANSI A 108 series of tile installation standards:
 - 1. Tile wall installations in wet areas, including showers, tub enclosures,

TECHNICAL SPECIFICATIONS FOR GLENDALE FIRE STATION

SECTION 09310 - CERAMIC TILE

laundries, and swimming pools.

3.6 CLEANING AND PROTECTING

- A. Cleaning: On completion of placement and grouting, clean all ceramic tile surfaces so they are free of foreign matter.
 - 1. Remove latex-portland cement grout residue from tile as soon as possible.
 - 2. Unglazed tile may be cleaned with acid solutions only when permitted by tile and grout manufacturers written instructions, but no sooner than 10 days after installation. Protect metal surfaces, cast iron, and vitreous plumbing fixtures from effects of acid cleaning. Flush surface with clean water before and after cleaning.
 - 3. Remove temporary protective coating by method recommended by coating manufacturer that is acceptable to brick and grout manufacturer. Trap and remove coating to prevent it from clogging drains.
- B. Finished Tile Work: Leave finished installation clean and free of cracked, chipped, broken, unbonded, and otherwise defective tile work.
- C. Provide final protection and maintain conditions, in a manner acceptable to manufacturer and Installer that ensure tile is without damage or deterioration at the time of Substantial Completion.
 - 1. When recommended by tile manufacturer, apply a protective coat of neutral protective cleaner to completed tile walls and floors. Protect installed tile work with kraft paper or other heavy covering during construction period to prevent staining, damage, and wear.
 - 2. Prohibit foot and wheel traffic from tiled floors for at least 7 days after grouting is completed.
- D. Before final inspection, remove protective coverings and rinse neutral cleaner from tile surfaces.

END OF SECTION 09310

TECHNICAL SPECIFICATIONS FOR GLENDALE FIRE STATION

SECTION 09670 FLUID APPLIED RESINOUS FLOORING

1. GENERAL

1.1. SECTION INCLUDES

- A. High-performance coatings including the following:
 - 1. Industrial fluid applied resinous flooring systems.

1.2. RELATED SECTIONS

- A. Section 03 - Cast-in-Place Concrete.

1.3. REFERENCES

- A. ASTM F 1869: Standard Test Method for Measuring Moisture Vapor Emission Rate of Concrete Subfloor Using Anhydrous Calcium Chloride.
- B. ASTM F 2170: Standard Test Method for Determining Relative Humidity in Concrete Floor Slabs Using in situ Probes.

1.4. SUBMITTALS

- A. Submit under provisions of Section 01 30 00 - Administrative Requirements.
- B. Coordinate with Section 01 30 00 - Administrative Requirements.
- C. Product Data: Manufacturer's data sheets on each product to be used, including:
 - 1. Submit descriptive data and specific recommendations for mixing, application, curing including any precautions of special handling instructions required to comply with the Occupational Safety and Health Act.
 - 2. Prepare instructions and recommendations.
 - 3. Submit storage and handling requirements and recommendations.
- D. Selection Samples: For each finish product specified, submit maximum of three samples, 6 inches by 6 inches for each color and type of coating available from manufacturer's full range.
- E. Verification Samples: For each finish product specified, submit maximum of three samples, 6 inches by 6 inches for each color and type of coating as specified.
- F. Maintenance Literature: Submit two copies of manufacturer's maintenance recommendations.

1.5. QUALITY ASSURANCE

- A. Manufacturer Qualifications: Materials used in the floor surfacing shall be the products of a single manufacturer.
- B. Installer Qualifications:
 - 1. Installer shall be acceptable to Architect and manufacturer.
 - 2. Installation shall be performed by an applicator with a minimum of 3 years experience in work of similar nature and scope. Installer shall be approved by the manufacturer of the floor surfacing materials. The Contractor shall furnish a written statement from the manufacturer that the installer is acceptable.
 - 3. Contractor shall have proven experience with specified system.
- C. Certification:

1. Manufacturer shall furnish statement attesting that materials meet specification requirements.
 2. Manufacturer shall furnish properly labeled material and Technical/Safety Data Sheets which comply to current state and federal requirements.
- D. Pre-Construction Meeting:
1. Pre-job meeting between Contractor, Architect, and installer shall be held to discuss concrete substrate, location of joints and/or saw cuts to minimize sub-floor cracking.
- E. Mock-Up: Provide an installed mock-up for evaluation of surface preparation techniques and application workmanship.
1. Finish areas designated by Architect.
 2. Mock-up size shall not be less than 50 square feet.
 3. Acceptable mock-up to be standard of quality for installed work.
 4. Unacceptable installed work to be removed and replaced or refinished until acceptable.

1.6. DELIVERY, STORAGE, AND HANDLING

- A. Delivery: Deliver manufacturer's unopened containers to the work site. Packaging shall bear the manufacturer's name, label, and the following list of information:
1. Product name and type (description).
 2. Application and use instructions.
 3. Surface preparation.
 4. VOC content.
 5. Environmental issues.
 6. Batch date.
 7. Color number.
- B. Storage: Store and dispose of solvent-based materials, and materials used with solvent-based materials, in accordance with requirements of local authorities having jurisdiction.
- C. Store materials in an area that is within the acceptable temperature range, per manufacturer's instructions. Protect from freezing.
- D. Handling: Maintain a clean, dry storage area, to prevent contamination or damage to the coatings.

1.7. PROJECT CONDITIONS

- A. Maintain the ambient room and floor temperature at 60 degree F (15 degrees C) or above for a period extending from 72 hours before or per manufacturer's technical data sheet, during and after floor installation. Concrete to receive surfacing shall have cured for at least 28 days and be free of all curing compounds.
- B. Maintain environmental conditions (temperature, humidity, and ventilation) within limits recommended by manufacturer for optimum results. Do not install products under environmental conditions outside manufacturer's absolute limits.
- C. When using polyureas or moisture cured urethane products, pay special attention to humidity levels. At higher humidity levels, these products will have a shorter working time.

1.8. WARRANTY

- A. The technical data and suggestions of use are correct to the best of our knowledge, and offered in good faith. The statements of this specification do not constitute a warranty, expressed, or implied, as to the performance of these products. As conditions and use of our materials are beyond our control, we can guarantee these products only to conform to our standards of quality, and our liability, if any, will be limited to replacement of defective materials. All technical information is subject to change without notice.

- B. Special written project warranties may be issued on a request basis at the discretion of the Rust-Oleum Corporation Technical and Legal Departments and would not be contained within this specification document.

2.PRODUCTS

2.1. MANUFACTURERS

- A. Acceptable Manufacturer: Rust-Oleum®, which is located at: 11 Hawthorn Pkwy.; Vernon Hills, IL 60061; Toll Free Tel: 800-323-3584; Tel: 847-367-7700; Fax: 847-816-2330; Email: technicalservice@rustoleum.com; Web: <https://www.rustoleum.com> .
- B. Specification and product questions should be directed to David O'Bryan at technicalservice@rustoleum.com .
- C. Requests for substitutions will be considered in accordance with provisions of Section 01 60 00 - Product Requirements.

2.2. CLEANERS AND PATCH/REPAIR SPECIALTY PRODUCTS

- A. Cleaners:
 - 1. Rust-Oleum Concrete Saver Cleaning & Etching Solution #108.

2.3. INDUSTRIAL FLUID APPLIED RESINOUS FLOORING SYSTEMS

- A. Concrete Protection Systems (CPS):
 - 1. Rust-Oleum CPS OverKrete 8000 S 100% Solids Epoxy System.
 - a. Primer: RO CPS Penetrating Prime & Seal Primer applied at 6-8 mils DFT.
 - b. Base Coat: RO CPS OverKrete 8000 S 100% Solids Epoxy applied at 16 mils DFT.
 - c. Finish: RO CPS OverKrete 8000 S 100% Solids Epoxy applied at 16 mils DFT.

3.EXECUTION

3.1. EXAMINATION

- A. The Contractor shall review the product manufacturer's special instructions for surface preparation, application, temperature, re-coat times, and product limitations.
- B. The Contractor shall review product health and safety precautions listed by the manufacturer.
- C. The Contractor shall be responsible for enforcing on site health and safety requirements associated with the Work.
- D. Ensure that surfaces to receive coating are dry immediately prior to application.
- E. Ensure that moisture-retaining substrates to receive coating have moisture content within tolerances allowed by coating manufacturer.
- F. Examine areas to receive coatings for:
 - 1. Concrete surfaces shall be in sound condition and properly prepared prior to flooring system installation.
 - 2. Defects in existing work that affect proper execution of coating work.
 - 3. Deviations beyond allowable tolerances for the concrete slab work.
- G. Correct conditions that could impair performance or appearance of coatings in accordance with specified surface preparation procedures before proceeding with coating application.

- H. If substrate preparation is the responsibility of another installer, notify Architect of unsatisfactory preparation before proceeding.

3.2. SURFACE PREPARATION

- A. All cleaning and surface preparations specified herein are minimums. Prepare substrate to receive coating in accordance with manufacturer's recommendations.
- B. All surfaces to be coated shall be free of cracks, pits, fins, projections, or other imperfections that would interfere with the formation of a uniform, unbroken coating film.
- C. Substrate shall be free of dirt, waxes, curing agents, and other foreign materials prior to mechanical surface preparation.
- D. New concrete shall have cured for a minimum 30 days prior to coating application. If a cure and seal agent was added to the concrete or applied after initial cure, the concrete must be abrasive blast cleaned or mechanically abraded to remove the sealer and expose fresh concrete.
- E. Acceptable Substrates:
 - 1. Level tolerance: Concrete sub-floor shall be level with a maximum variation from level of 1/4 inch (6 mm) in 10 feet (3048 mm). Any irregularity of the surface requiring patching and/or leveling shall be done using material approved by the manufacturer.
 - 2. Concrete floor shall have a steel trowel finish.
 - 3. Concrete shall be cured a minimum of 28 days. No curing agents shall be used in areas to receive coating.
 - 4. Concrete slab shall have an efficient moisture barrier of minimum 10 mils (.2540 mm) placed directly under the concrete slab. Do not use vapor barrier manufactured with recycled content. Testing shall be done to verify that the moisture vapor emission rate of the slab does not exceed that as recommended by the manufacturer at time of installation of the epoxy coating flooring. Moisture vapor emission and moisture content testing shall conform with the requirements of ASTM F 1869 (Calcium Chloride Test) and ASTM F 2170 (Relative Humidity Probe Test). If test results show excessive levels of moisture content or vapor emission rate above that recommended by the manufacturer, apply manufacturer's recommended moisture vapor emission control material.
 - 5. Saw cutting of control joints shall be done between 12 and 24 hours after placement of the structural concrete.
- F. Concrete, SSPC-SP13 or NACE 6: This standard gives requirements for surface preparation of concrete by mechanical, chemical, or thermal methods prior to the application of bonded protective coating or lining systems. The requirements of this standard are applicable to all types of cementitious surfaces including cast-in-place concrete floors and walls, precast slabs, masonry walls, and shotcrete surfaces. An acceptable prepared concrete surface should be free of contaminants, laitance, loosely adhering concrete, and dust, and should provide a sound, uniform substrate suitable for the application of protective coating or lining systems.
- G. Concrete surfaces shall be mechanically abraded, or abrasive blast cleaned to remove all laitance to provide a uniform surface profile with a profile depth recommended by the fluid applied resinous system selected per ICRI CSP Standards.
- H. The coating contractor is to examine the substrate to determine if it is in satisfactory condition to receive the specified floor system. Obtain coating contractor's written report listing conditions detrimental to performance of work in this specification. Do not proceed with the application of specified floor coating until unsatisfactory conditions have been corrected.

3.3. MIXING AND THINNING

- A. Mixing:
 - 1. The base component and activator must be combined with power mixing. Hand mixing is not adequate.
 - 2. Scrape out the container of the activator to transfer as much material as possible.
 - 3. Use a suitable mixing blade which will not entrain air. Mix at 500-750 RPM for 1-3 minutes.
 - 4. Application must begin as soon as the material has been completely mixed.
- B. Thinning: Thinning is not required. Do not thin.

3.4. APPLICATION

- A. Weather Conditions:
 - 1. Apply when air and surface temperatures are between 60-80 degrees F (15-27 degrees C) and surface temperature is at least 5 degrees F (3 degrees C) above the dew point.
 - 2. The relative humidity should not be greater than 85 percent.
- B. Coating Application:
 - 1. Do not attempt to work out of the container. Immediately after mixing material, pour out the activated material in a long thin stripe across the top of the work section of floor. Use only the material that flows naturally out of the container.
 - 2. Do not scrape out the container of activated material or turn buckets upside down on floor to drain. Doing so may result with transfer of un-activated material to the floor which will result with soft spots in the coating.
 - 3. Install in accordance with manufacturer's instructions.
 - 4. Locate all flexible joints required.
 - 5. Provide accessories necessary for complete installation.
- C. Protection of Surfaces:
 - 1. The Coating Contractor shall be responsible for protecting all adjacent surfaces from spills, drips, or any other form of coating damage.
 - 2. The coating contractor and its subcontractors shall be responsible for removing spots or repairing damaged surfaces to the satisfaction of the Architect.

3.5. CLEAN-UP

- A. Clean-up shall be done to remove all spills, drips, overspray, or other unwanted coating from all surfaces not intended to be coated.
- B. All used rags, brushes, roller covers, and other application related materials shall be removed from the work site and disposed in a proper manner and in accordance with local waste regulations.
- C. All equipment, staging, ladders, and other contractor materials brought onto the jobsite by the contractor shall be removed at the conclusion of the job in a timely manner.

3.6. PROTECTION

- A. Protect installed products until completion of project.
- B. Touch-up, repair or replace damaged products before Substantial Completion.

END OF SECTION

TECHNICAL SPECIFICATIONS FOR GLENDALE FIRE STATION

SECTION 09900 - PAINTING

PART 1 - GENERAL

1.1 RELATED DOCUMENTS

- A. Drawings and general provisions of the Contract, including General and Supplementary Conditions and Division 1 Specification Sections, apply to this Section.

1.2 SUMMARY

- A. This Section includes surface preparation, painting, and finishing of exposed interior and exterior items and surfaces.
 - 1. Surface preparation, priming, and finish coats specified in this Section are in addition to shop-priming and surface treatment specified under other Sections.
- B. Paint exposed surfaces whether or not colors are designated in schedules, except where a surface or material is specifically indicated not to be painted or is to remain natural. Where an item or surface is not specifically mentioned, paint the same as similar adjacent materials or surfaces. If color or finish is not designated, the Architect will select from standard colors or finishes available.
 - 1. Painting includes field-painting exposed bare and covered pipes and ducts (including color coding), hangers, exposed steel and iron work, and primed metal surfaces of mechanical and electrical equipment
- C. Painting is not required on prefinished items, finished metal surfaces, concealed surfaces, operating parts, and labels.
- D. Concealed surfaces not to be painted include wall or ceiling surfaces in the following generally inaccessible areas:
 - 1. Foundation spaces.
 - 2. Furred areas.
 - 3. Pipe spaces.
 - 4. Duct shafts.
- E. Operating parts not to be painted include moving parts of operating equipment.
- F. Labels: Do not paint over Underwriters laboratories, Factory Mutual or other code-required labels or equipment name, identification, performance rating, or nomenclature plates.

**TECHNICAL SPECIFICATIONS FOR GLENDALE FIRE STATION
SECTION 09900 - PAINTING**

- G. Related Sections: The following Sections contain requirements that relate to this Section: Division 5 Section "Metal Fabrications" for shop-priming ferrous metal.
1. Division 6 Section "Interior Architectural Woodwork" for finishing interior architectural woodwork not indicated for shop finish.
 2. Division 8 Section "Standard Steel Doors and Frames" for shop-priming steel doors and Frames
 3. Division 9 Section "Wall Coverings" for substrate sealer under wall coverings.
 4. Divisions 15 and 16: Painting mechanical and electrical work is specified in Divisions 15 and 16, respectively.

1.3 SUBMITTALS

- A. General: Submit the following according to Conditions of the Contract and Division 1 Specification Sections.
- B. Product data for each paint system specified, including block fillers and primers.
1. Provide the manufacturer's technical information including label analysis and instructions for handling, storage, and application of each material proposed for use.
 2. List each material and cross-reference the specific coating, finish system, and application. Identify each material by the manufacturer's catalog number and general classification.
- C. Samples for initial color selection in the form of manufacturer's color charts.
1. Color selections to be made by Owner.
- D. Samples for Verification Purposes: Provide samples of each color and material to be applied, with texture to simulate actual conditions, on representative samples of the actual substrate.
1. Provide stepped samples, defining each separate coat, including fillers and primers. Use representative colors when preparing samples for review. Resubmit until required sheen, color, and texture are achieved.
 2. Provide a list of material and application for each coat of each sample label each sample as to location and application.
 3. Submit samples on the following substrates for the Architect's review of

TECHNICAL SPECIFICATIONS FOR GLENDALE FIRE STATION

SECTION 09900 - PAINTING

color and texture only:

4. Painted Wood and Drywall: Provide two 12-inch-square samples of each color and material on hardboard.
5. Stained or Natural Wood: Provide two 4-by-8-inch samples of natural and stained wood finish on actual wood surfaces.
6. Ferrous Metal: provide two 4-inch-square samples of flat metal and two 8-inch-long samples of solid metal for each color and finish.

1.4 QUALITY ASSURANCE

- A. Applicator Qualifications: Engage an experienced applicator who has completed painting system applications similar in material and extent to those indicated for the Project that have resulted in a construction record of successful in-service performance.
- B. Single-Source Responsibility: Provide primers and undercoat paint produced by the same manufacturer as the finish coats.
- C. Field Samples: On wall surfaces and other exterior and interior components, duplicate finishes of prepared samples. Provide full-coat finish samples on at least 100 sq. ft. of surface until required sheen, color, and texture are obtained; simulate finished lighting conditions for review of in-place work.
 1. Final acceptance of colors will be from job-applied samples.
 2. The Architect will select one room or surface to represent surfaces and conditions for each type of coating and substrate to be painted. Apply coatings in this room or surface according to the schedule or as specified.
 - a. After finishes are accepted, this room or surface will be used to evaluate coating systems of a similar nature.

1.5 DELIVERY, STORAGE, AND HANDLING

- A. Deliver materials to the job site in the manufacturers original, unopened packages and containers bearing manufacturer's name and label, and the following information:
 1. Product name or title of material.
 2. Product description (generic classification or binder type).

**TECHNICAL SPECIFICATIONS FOR GLENDALE FIRE STATION
SECTION 09900 - PAINTING**

3. Manufacturer's stock number and date of manufacture.
 4. Contents by volume, for pigment and vehicle constituents.
 5. Thinning instructions.
 6. Application instructions.
 7. Color name and number.
- B. Store materials not in use in tightly covered containers in a well-ventilated area at a minimum ambient temperature of 45 deg F (7 deg C). Maintain containers used in storage in a clean condition, free of foreign materials and residue.
1. Protect from freezing. Keep storage area neat and orderly. Remove oily rags and waste daily. Take necessary measures to ensure that workers and work areas are protected from fire and health hazards resulting from handling, mixing, and application.

1.6 JOB CONDITIONS

- A. Apply water-based paints only when the temperature of surfaces to be painted and surrounding air temperatures are between 50 deg F (10 deg C) and 90 deg F (32 deg C).
- B. Apply solvent-thinned paints only when the temperature of surfaces to be painted and surrounding air temperatures are between 45 deg F (7 deg C) and 95 deg F (35 deg C).
- C. Do not apply paint in snow, rain, fog, or mist; or when the relative humidity exceeds 85 percent; or at temperatures less than 5 deg F (3 deg C) above the dew point; or to damp or wet surfaces.
 1. Painting may continue during inclement weather if surfaces and areas to be painted are enclosed and heated within temperature limits specified by the manufacturer during application and drying periods.

PART 2 - PRODUCTS

2.1 MANUFACTURERS

- A. Manufacturer: Subject to compliance with requirements, provide products of one of the following:

TECHNICAL SPECIFICATIONS FOR GLENDALE FIRE STATION
SECTION 09900 - PAINTING

PPG Industries, Pittsburgh Paints (PPG)
The Sherwin-Williams Company (S-W).

2.2 PAINT MATERIALS, GENERAL

- A. Material Compatibility: Provide block fillers, primers, finish coat materials, and related materials that are compatible with one another and the substrates indicated under conditions of service and application, as demonstrated by the manufacturer based on testing and field experience.
- B. Material Quality: Provide the manufacturers best quality trade sale paint material of the various coating types specified. Paint material containers not displaying manufacturer's product identification will not be acceptable.
 - 1. Proprietary Names: Use of manufacturer's proprietary product names to designate colors or materials is not intended to imply that products named are required to be used to the exclusion of equivalent products of other manufacturers. Furnish the manufacturer's material data and certificates of performance for proposed substitutions.
- C. Colors: Provide custom colors of the finished paint systems to match the Architect's samples.

PART 3 - EXECUTION

3.1 EXAMINATION

- A. Examine substrates and conditions under which painting will be performed for compliance with paint application requirements: Surfaces receiving paint must be thoroughly dry before paint is applied.
 - 1. Do not begin to apply paint until unsatisfactory conditions have been corrected.
 - 2. Start of painting will be construed as the Applicators acceptance of surfaces and conditions within a particular area.
- B. Coordination of Work: Review other Sections in which primers are provided to ensure compatibility of the total system for various substrates. On request, furnish information on characteristics of finish materials to ensure use of compatible primers.
 - 1. Notify the Architect about anticipated problems using the materials specified over substrates primed by others.

3.2 PREPARATION

TECHNICAL SPECIFICATIONS FOR GLENDALE FIRE STATION
SECTION 09900 - PAINTING

- A. General: Remove hardware and hardware accessories, plates, machined surfaces, lighting fixtures, and similar items already installed that are not to be painted, or provide surface-applied protection prior to surface preparation and painting. Remove these items, if necessary, to completely paint the items and adjacent surfaces. Following completion of painting operations in each space or area, have items reinstalled by workers skilled in the trades involved.

- B. Cleaning: Before applying paint or other surface treatments, clean the substrates of substances that could impair the bond of the various coatings. Remove oil and grease prior to cleaning. Schedule cleaning and painting so dust and other contaminants from the cleaning process will not fall on wet, newly painted surfaces.

- C. Surface Preparation: Clean and prepare surfaces to be painted according to the manufacturer's instructions for each particular substrate condition and as specified.
 - 1. Provide barrier coats over incompatible primers or remove and reprime. Notify Architect in writing about anticipated problems using the specified finish-coat material with substrates primed by others.

 - 2. Wood: Clean surfaces of dirt, oil, and other foreign substances with scrapers, mineral spirits, and sandpaper, as required. Sand surfaces exposed to view smooth and dust off.
 - a. Scrape and clean small, dry, seasoned knots, and apply a thin coat of white shellac, or other recommended knot sealer before applying primer. After priming, fill holes and imperfections in finish surfaces with putty or plastic wood filler. Sand smooth when dried.

 - b. Prime, stain, or seal wood to be painted immediately upon delivery. Prime edges, ends, faces, undersides, and backsides of wood, including cabinets, counters, cases, and paneling.

 - c. When transparent finish is required, backprime with spar varnish.

 - d. Seal tops, bottoms, and cutouts of unprimed wood doors with a heavy coat of varnish or sealer immediately upon delivery.

 - 3. Ferrous Metals: Clean ungalvanized ferrous - metal surfaces that have not been shop-coated; remove oil, grease, dirt, loose mill scale, and other foreign substances. Use solvent or mechanical cleaning methods that comply with recommendations of the Steel Structures Painting Council (SSPC).

TECHNICAL SPECIFICATIONS FOR GLENDALE FIRE STATION

SECTION 09900 - PAINTING

4. Blast steel surfaces clean as recommended by the paint system manufacturer and - according to requirements of SSPC specification SSPC-SP 10.
 5. Treat bare and sandblasted or pickled clean metal with a metal treatment wash coat before priming.
 6. Touch UP bare areas and shop-applied prime coats that have been damaged. Wire-brush, clean with solvents recommended by the paint manufacturer, and touch up with the same primer as the shop coat.
- D. Galvanized Surfaces: Clean galvanized surfaces with non petroleum-based solvents so that the surface is free of oil and surface contaminants. Remove pretreatment from galvanized sheet metal fabricated from coil stock by mechanical methods.
- E. Materials Preparation: Carefully mix and prepare paint materials according to manufacturer's directions.
1. Maintain containers used in mixing and applying paint in a clean condition, free of foreign materials and residue.
 2. Stir material before application to produce a mixture of uniform density; stir as required during application. Do not stir surface film into material. Remove film and, if necessary, strain material before using.
 3. Use only thinners approved by the paint manufacturer and only within recommended limits.
- F. Tinting: Tint each undercoat a lighter shade to facilitate identification of each coat where multiple coats of the same material are applied. Tint undercoats to match the color of the finish coat, but provide sufficient differences in shade of undercoats to distinguish each separate coat.

3.3 APPLICATION

- A. General: Apply paint according to manufacturer's directions. Use applicators and techniques best suited for substrate and type of material being applied.
- B. Do not paint over dirt, rust, scale, grease, moisture, scuffed surfaces, or conditions detrimental to formation of a durable paint film.
1. Paint colors, surface treatments, and finishes are indicated in the schedules.
 2. Provide finish coats that are compatible with primers used.

TECHNICAL SPECIFICATIONS FOR GLENDALE FIRE STATION

SECTION 09900 - PAINTING

3. The number of coats and the film thickness required are the same regardless of the application method. Do not apply succeeding coats until the previous coat has cured as recommended by the manufacturer. Sand between applications where sanding is required to produce a smooth even surface according to the manufacturer's directions.
 4. Apply additional coats if undercoats, stains, or other conditions show through final coat of paint until paint film is of uniform finish, color, and appearance. Give special attention to ensure that surfaces, including edges, corners, crevices, welds, and exposed fasteners, receive a dry film thickness equivalent to that of flat surfaces;
 5. The term exposed surfaces includes areas visible when permanent or built-in fixtures, convactor covers, covers for finned tube radiation, grilles, and similar components are in place. Extend coatings in these areas, as required, to maintain the system integrity and provide desired protection.
 6. Paint surfaces behind movable equipment and furniture the same as similar exposed surfaces. Before the final installation of equipment, paint surfaces behind permanently fixed equipment or furniture with prime coat only.
 7. Paint interior surface of ducts, where visible through registers or grilles, with a flat, nonspecular black paint.
 8. Paint back sides of access panels and removable or hinged covers to match exposed surfaces.
 9. Finish interior of wall and base cabinets and similar field-finished casework to match exterior.
 10. Finish exterior doors on tops, bottoms, and side edges same as exterior faces.
 11. Sand lightly between each succeeding enamel or varnish coat.
 12. Omit primer on metal surfaces that have been shop-primed and touch-up painted.
- C. Scheduling Painting: Apply first coat to surfaces that have been cleaned, pretreated, or otherwise prepared for painting as soon as practicable after preparation and before subsequent surface deterioration.
1. Allow sufficient time between successive coats to permit proper drying. Do not recoat until paint has dried to where it feels firm, does not deform or feel sticky under moderate thumb pressure, and where application of another coat of paint does not cause the undercoat to lift or lose adhesion.

TECHNICAL SPECIFICATIONS FOR GLENDALE FIRE STATION
SECTION 09900 - PAINTING

- D. Application Procedures: Apply paints and coatings by brush, roller, spray, or other applicators according to the manufacturer's directions.
1. Brushes: Use brushes best suited for the material applied.
 2. Rollers: Use rollers of carpet, velvet back, or high-pile sheep's wool as recommended by the manufacturer for the material and texture required.
 3. Minimum Coating Thickness: Apply materials no thinner than the manufacturer's recommended spreading rate. Provide the total dry film thickness of the entire system as recommended by the manufacturer.
 4. Prime Coats: Before applying finish coats, apply a prime coat of material, as recommended by the manufacturer, to material that is required to be painted or finished and that has not been prime-coated by others. Recoat, primed and sealed surfaces where evidence of suction spots or, unsealed areas in first coat appears, to ensure a finish coat with no burn-through or other defects due to insufficient sealing.
 5. Enamel Finish: Roll and redistribute paint to an even and fine texture. Leave no evidence of rolling such as laps, irregularity in texture, skid marks, or other surface imperfections.
 6. Pigmented (Opaque) Finishes: Completely cover to provide a smooth, opaque surface of uniform finish, color, appearance, and coverage. Cloudiness, spotting, holidays, laps, brush marks, runs, sags, ropiness, or other surface imperfections will not be acceptable.
 7. Transparent (Clear) Finishes: Use multiple coats to produce a glass-smooth surface film of even luster. Provide a finish free of laps, cloudiness, color irregularity, runs, brush marks, orange peel, nail holes, or other surface imperfections.
 - a. Provide satin finish for final coats.
 8. Completed Work: Match approved samples for color, texture, and coverage. Remove, refinish, or repaint work not complying with specified requirements.

3.4 FIELD QUALITY CONTROL

- A. The Owner reserves the right to invoke the all applicable test procedures at any time and as often as the Owner deems necessary during the period when paint is being applied:

TECHNICAL SPECIFICATIONS FOR GLENDALE FIRE STATION

SECTION 09900 - PAINTING

1. The Owner will engage the services of an independent testing agency to sample the paint material being used. Samples of material delivered to the Project will be taken, identified, sealed, and certified in the presence of the Contractor.
2. If test results show material being used does not comply with specified requirements, the Contractor may be directed to stop painting, remove noncomplying paint, pay for testing, repaint surfaces coated with rejected paint, and remove rejected paint from previously painted surfaces if, upon repainting with specified paint, the two coatings are incompatible.

3.4 CLEANING

- A. Cleanup: At the end of each work day, remove empty cans, rags, rubbish, and other discarded paint materials from the site.
 1. After completing painting, clean glass and paint-spattered surfaces. Remove spattered paint by washing and scraping. Be careful not to scratch or damage adjacent finished surfaces. .

3.4 PROTECTION.

- A. Protect work of other trades, whether being painted or not, against damage by painting. Correct damage by cleaning, repairing or replacing, and repainting as acceptable to Architect.
- B. Provide "Wet Paint" signs to protect newly painted finishes. Remove temporary protective wrappings provided by others to protect their work after completing painting operations.
 1. At completion of construction activities of other trades, touch up and restore damaged or defaced painted surfaces..

3.5 INTERIOR PAINT SCHEDULE

- A. General: Provide the following paint systems for the various substrates, as indicated.

Gypsum Drywall Systems:

Odorless Semi-gloss Alkyd Enamel Finish: Three coats with total dry film thickness not less than 2.5 mils.

Primer: White, interior, latex-based primer.

First and Second Coats: Interior, eggshell, odorless, alkyd enamel.

TECHNICAL SPECIFICATIONS FOR GLENDALE FIRE STATION SECTION 09900 - PAINTING

Woodwork and Hardboard: indicated for painted finish

Semi-gloss Enamel Finish: Three coats.

Undercoat: Interior enamel undercoat.

First and second Coats: Interior, semi-gloss, odorless, alkyd enamel.

Devoe: 26XX Velour Alkyd Semi-gloss Enamel.

PPG: 27 Line Wallhide Semi-gloss Enamel.

S-W: Classic 99 Semi-gloss Enamel A40 Series.

Stained Woodwork:

Stained-Varnish Rubbed Finish: Three finish coats over stain plus filler on open-grain wood. Wipe filler before applying first varnish coat.

Stain Coat: Oil-type interior wood stain.

First Coat: Cut shellac.

Filler Coat: Paste wood filler.

Second and Third Coats: Oil rubbing varnish.

Stained Doors:

Stained-Varnish Rubbed Finish: Three finish coats over stain plus filler on open grain wood. Wipe filler before applying first varnish coat.

Stain Coat: Oil-type interior wood stain.

First Coat: Cut shellac.

Filler Coat: Paste wood filler.

Second and Third Coats: Oil rubbing varnish.

Ferrous Metal:

Semi-gloss Enamel Finish: Two coats over primer with total dry film thickness not less than 2.5 mils.

Primer: Synthetic, quick-drying, rust-inhibiting primer.

**TECHNICAL SPECIFICATIONS FOR GLENDALE FIRE STATION
SECTION 09900 - PAINTING**

Undercoat: Interior enamel undercoat.

Finish Coat: Interior, semi-gloss, odorless, alkyd enamel.

END OF SECTION 09900

TECHNICAL SPECIFICATIONS FOR GLENDALE FIRE STATION

SECTION 09910 LIGHT COMMERCIAL/RESIDENTIAL PAINTING

1. GENERAL

1.1. SECTION INCLUDES

- A. Light commercial/residential painting, including surface preparation.
 - 1. Interior light commercial/residential painting.
 - 2. Exterior light commercial/residential painting.

1.2. RELATED SECTIONS - INTERIOR

- A. Division 3 - Concrete - Cast in Place.
- B. Division 8 - Wood - Doors, Trim, Paneling.
- C. Division 9 - Drywall - (Walls, Ceilings, Gypsum Board and similar items).

1.3. RELATED SECTIONS - EXTERIOR

- A. Division 4 - Unit Masonry

1.4. REFERENCES

- A. Occupational Safety and Health Act (OSHA) - Safety Standards.
- B. American National Standards Institute (ANSI) - Performance Standards.
- C. Paint Decorating Contractors of America (PDCA) - Application Standard.
- D. American Society for Testing Materials (ASTM) - Testing Methods.

1.5. DEFINITIONS

- A. Commercial as used in this Section refers to a product well suited for a commercial application.
- B. DFT as used in this Section refers to the Dry Film Thickness of the coating.
- C. Enamel refers to any acrylic or alkyd (oil) base paint which dries leaving an eggshell, pearl, satin, semi-gloss or high gloss enamel finish.
- D. DTM as used in this Section refers to paint that is applied Direct To Metal.
- E. Paints are available in a wide range of sheens or glosses, as measured by a gloss meter from a 60 and/or 85 degree angle from vertical, as a percentage of the amount of light that is reflected. The following terms are used to describe the gloss of our products. The list below is provided for general guidance; refer to the technical data sheet for the actual gloss/sheen level for each product.
 - 1. Flat - Less than 5 Percent.
 - 2. Eggshell - 5 - 20 Percent.
 - 3. Satin - 20 - 35 Percent.
 - 4. Semi-Gloss - 30 - 65 Percent.
 - 5. Gloss - Over 65 Percent.

1.6. SUBMITTALS

- A. Submit under provisions of Section 01 30 00 - Administrative Requirements.
- B. Product Data: Provide a complete list of all products to be used, with the following information for each:
 - 1. Manufacturer's name, product name and/or catalog number, and general product category.
 - 2. Cross-reference to specified paint system(s) that the product is to be used in; include description of each system.
- C. Samples: Submit three paper samples, 5 inches by 7 inches (127mm x 178mm) in size, illustrating selected colors for each color and system selected with specified coats cascaded.
- D. Manufacturer's Instructions: Indicate special surface preparation procedures.
- E. Maintenance Data: Submit data on cleaning, touch-up, and repair of painted and coated surfaces.

1.7. QUALITY ASSURANCE

- A. Manufacturer Qualifications: All primary products specified in this section will be supplied by a single manufacturer with a minimum of ten years experience.
- B. Installer Qualifications: All products listed in this section are to be applied by a Painting Contractor with a minimum of five years demonstrated experience in surface preparation and field application of the same type and scope as specified.
- C. Mock-Up: Provide a mock-up for evaluation of surface preparation techniques and application workmanship.
 - 1. Mock-up areas designated by Architect.
 - 2. Do not proceed with remaining work until workmanship, color, and sheen are approved by Architect.
 - 3. Approved mock-up areas will serve as the standard for remaining Work.
 - 4. Refinish mock-up area as required to produce acceptable Work.

1.8. DELIVERY, STORAGE, AND HANDLING

- A. Store products in manufacturer's unopened packaging until ready for installation.
- B. Store and dispose of solvent-based materials, and materials used with solvent-based materials, in accordance with requirements of local authorities having jurisdiction.
- C. Disposal:
 - 1. Never pour leftover coating down any sink or drain. Use up material on the job or seal can and store safely for future use.
 - 2. Do not incinerate closed containers.
 - 3. For specific disposal or recycle guidelines, contact the local waste management agency or district. Recycle whenever possible.

1.9. PROJECT CONDITIONS

- A. Maintain environmental conditions (temperature, humidity, and ventilation) within limits recommended by manufacturer for optimum results. Do not install products under environmental conditions outside manufacturer's recommended limits.

1.10. WARRANTY

- A. Inspection of all surfaces to be coated must be done by the manufacturer's representative to insure proper preparation prior to application. All thinners, fillers, primers and finish coatings shall be from the same manufacturer to support a product warranty. Products other than those submitted shall be accompanied by a letter stating its fitness for use and compatibility.

- B. At project closeout, provide to the Owner or owner's representative an executed copy of the Manufacturer's standard form outlining the terms and conditions of and any exclusions to their Limited Warranty against Manufacturing Defect.

1.11. EXTRA MATERIALS

- A. At project closeout, supply the Owner or owner's representative one gallon of each product for touch-up purposes. Cans shall be clearly marked with color name, number and type of paint.
- B. At project closeout, provide the color mixture name and code to the Owner or owner's representative for accurate future color matching.

2.PRODUCTS

2.1. MANUFACTURERS

- A. Acceptable Manufacturer: Benjamin Moore & Co., which is located at: 101 Paragon Dr; Montvale, NJ 07645; Toll Free Tel: 866-708-9181; Email: [request info \(info@benjaminmoore.com\)](mailto:request_info@benjaminmoore.com); Web: <https://www.benjaminmoore.com> | <https://www.benjaminmoore.com/en-ca>
- B. Substitutions: Requests for substitutions will be considered in accordance with provisions of Section 01 60 00 - Product Requirements.

2.2. MATERIALS - GENERAL

- A. Compatibility: Provide materials that are compatible with one another and the substrates indicated under conditions of service and application, as demonstrated by manufacturer based on testing and field experience.

2.3. MIXING AND TINTING

- A. Except where specifically noted in this section, all paint shall be ready-mixed and pre-tinted. Agitate all paint prior to and during application to ensure uniform color, gloss, and consistency.
- B. Thinner addition shall not exceed manufacturer's printed recommendations. Do not use kerosene or other organic solvents to thin water-based paints.
- C. Where paint is to be sprayed, thin according to manufacturer's current guidelines.

2.4. LIGHT COMMERCIAL/RESIDENTIAL INTERIOR PAINT SYSTEMS

- A. Wood- Doors, Trim, Paneling:
 - 1. Latex Systems:
 - a. Eggshell Finish:
 - 1. First Coat: Benjamin Moore Fresh Start Multi-Purpose Latex Primer N023 (44 g/L), MPI # 6, 17, 17 X-Green, 39, 137, 137 X-Green, LEED v4, qualifies for CHPS credit.
 - 2. Second Coat: Benjamin Moore Regal Select Waterborne Interior Eggshell Finish 549.
 - 3. Third Coat: Benjamin Moore Regal Select Waterborne Interior Eggshell Finish 549.
- B. DRYWALL - (Walls, Ceilings, Gypsum Board and similar items):
 - 1. Latex Systems:
 - a. Matte Scuff Resistant Finish:
 - 1. First Coat: Benjamin Moore Ultra Spec 500 Interior Primer N534.
 - 2. Second Coat: Benjamin Moore Ultra Spec Scuff-X Interior Matte Finish

3. 484..
Third Coat: Benjamin Moore Ultra Spec Scuff-X Interior Matte Finish 484.
- C. Concrete - (Floors, non-vehicular):
1. Latex System- Self Priming:
 - a. Satin Best Option:
 1. First Coat: Benjamin Moore Latex Floor & Patio Low Sheen Enamel N122 (45 g/L), LEED 2009.
 2. Second Coat: Benjamin Moore Latex Floor & Patio Low Sheen Enamel N122 (45 g/L), LEED 2009.

2.5. LIGHT COMMERCIAL/RESIDENTIAL EXTERIOR PAINT SYSTEMS

- A. METAL- Misc. Iron, Ornamental Iron, Structural Iron and Steel, Ferrous Metal:
1. Alkyd System:
 - a. Gloss Finish Waterborne Alkyd:
 1. First Coat: Benjamin Moore Super Spec HP Alkyd Metal Primer P06 (323 g/L), MPI # 79.
 2. Second Coat: Benjamin Moore Advance Waterborne Interior Alkyd High Gloss N794 (48 g/L), MPI # 157, X-Green 157, LEED 2009, LEED V4.
 3. Third Coat: Benjamin Moore Advance Waterborne Interior Alkyd High Gloss N794 (48 g/L), MPI # 157, X-Green 157, LEED 2009, LEED V4.
- B. WOOD- Siding, Trim, Shutters, Sashes, Hardboard-Bare/Primed:
1. Latex System Options:
 - a. Satin Commercial Finish
 1. First Coat: Benjamin Moore Fresh Start High-Hiding All Purpose Primer 046 (44 g/L), MPI # 6, 17, 17 X-Green, 39, 50, 50X-Green, 137, 137 X-Green, LEED v4, qualifies for CHPS credit.
 2. Second Coat: Benjamin Moore Ultra Spec EXT Satin Finish N448 (46 g/L), MPI # 15.
 3. Third Coat: Benjamin Moore Ultra Spec EXT Satin Finish N448 (46 g/L), MPI # 15.

3.EXECUTION

3.1. EXAMINATION

- A. The Contractor shall review the product manufacturer's special instructions for surface preparation, application, temperature, re-coat times, and product limitations.
- B. The Contractor shall review product health and safety precautions listed by the manufacturer.
- C. The Contractor shall be responsible for enforcing on site health and safety requirements associated with the Work.
- D. Do not begin installation until substrates have been properly prepared.
- E. Ensure that surfaces to receive paint are dry immediately prior to application.
- F. Ensure that moisture-retaining substrates to receive paint have moisture content within tolerances allowed by coating manufacturer. Where exceeding the following values, promptly notify Architect and obtain direction before beginning work.
 1. Concrete and Masonry: 3-5 percent. Allow new concrete to cure a minimum of 28 days.
 2. Exterior Wood: 17 percent.
 3. Interior Wood: 15 percent.
 4. Interior Finish Detail Woodwork, Including Trim, and Casework: 10 percent.
 5. Plaster and Gypsum: 15 percent.

- 6. Concrete Slab-On-Grade: Perform calcium chloride test over 24 hour period or other acceptable test to manufacturer. Verify acceptable moisture transmission and pH levels.
- G. Examine surfaces to receive coatings for surface imperfections and contaminants that could impair performance or appearance of coatings, including but not limited to, loose primer, rust, scale, oil, grease, mildew, algae, or fungus, stains or marks, cracks, indentations, or abrasions.
- H. Correct conditions that could impair performance or appearance of coatings in accordance with specified surface preparation procedures before proceeding with coating application.

3.2. PREPARATION - GENERAL

- A. Clean surfaces thoroughly prior to coating application.
- B. Do not start work until surfaces to be finished are in proper condition to produce finished surfaces of uniform, satisfactory appearance.
- C. Stains and Marks: Remove completely, if possible, using materials and methods recommended by coating manufacturer; cover stains and marks which cannot be completely removed with isolating primer or sealer recommended by coating manufacturer to prevent bleed-through.
- D. Remove Mildew, Algae, and Fungus using materials and methods recommended by coating manufacturer.
- E. Remove dust and loose particulate matter from surfaces to receive coatings immediately prior to coating application.
- F. Remove or protect adjacent hardware, electrical equipment plates, mechanical grilles and louvers, lighting fixture trim, and other items not indicated to receive coatings.
- G. Move or protect equipment and fixtures adjacent to surfaces indicated to receive coatings to allow application of coatings.
- H. Protect adjacent surfaces not indicated to receive coatings.
- I. Prepare surfaces in accordance with manufacturer's instructions for specified coatings and indicated materials, using only methods and materials recommended by coating manufacturer.

3.3. SURFACE PREPARATION

- A. Concrete and Concrete Masonry: Clean surfaces free of loose particles, sand, efflorescence, laitance, form oil, curing compounds, and other substances which could impair coating performance or appearance.
- B. Concrete Floors: Remove contaminants which could impair coating performance or appearance. Verify moisture transmission and alkaline-acid balance recommended by coating manufacturer; mechanically abrade surface to achieve 80-100 grit medium-sandpaper texture.
- C. Existing Coatings:
 - 1. Remove surface irregularities by scraping or sanding to produce uniform substrate for coating application; apply one coat primer of type recommended by coating manufacturer for maximum coating adhesion.
 - 2. If presence of lead in existing coatings is suspected, cease surface preparation and notify Architect immediately.

- D. Gypsum Board: Repair cracks, holes and other surface defects with joint compound to produce surface flush with adjacent surfaces.
- E. Masonry Surfaces - Restored: Remove loose particles, sand, efflorescence, laitance, cleaning compounds and other substances that could impair coating performance or appearance.
- F. Metals - Aluminum, Mill-Finish: Clean and etch surfaces with a phosphoric acid-water solution or water based industrial cleaner. Flush with clean water and allow to dry, before applying primer coat.
- G. Metals - Copper: Clean surfaces with pressurized steam, pressurized water, or solvent washing.
- H. Metals - Ferrous, Unprimed: Remove rust or scale, if present, by wire brush cleaning, power tool cleaning, or sandblast cleaning; remove grease, oil, and other contaminants which could impair coating performance or appearance by solvent cleaning, with phosphoric-acid solution cleaning of welds, bolts and nuts; spot-prime repaired welds with specified primer.
- I. Metals - Ferrous, Shop-Primed: Remove loose primer and rust, if present, by scraping and sanding, feathering edges of cleaned areas to produce uniform flat surface; solvent-clean surfaces and spot-prime bare metal with specified primer, feathering edges to produce uniform flat surface.
- J. Metals - Galvanized Steel (not passivated): Clean with a water-based industrial strength cleaner, apply an adhesion promoter followed by a clean water rinse. Alternately, wipe down surfaces using clean, lint-free cloths saturated with xylene or lacquer thinner; followed by wiping the surface dry using clean, lint-free cloths.
- K. Metals - Galvanized Steel, Passivated: Clean with water-based industrial strength cleaner. After the surface has been prepared, apply recommended primer to a small area. Allow primer to cure for 7 days, and test adhesion using the "cross-hatch adhesion tape test" method in accordance with ASTM D 3359. If the adhesion of the primer is positive, proceed with a recommended coating system for galvanized metal.
- L. Metals - Stainless Steel: Clean surfaces with pressurized steam, pressurized water, or water-based industrial cleaner.
- M. Plaster: Repair cracks, holes and other surface defects as required to maintain proper surface adhesion. Apply patching plaster or Joint compound and sand to produce surface flush with adjacent undamaged surface. Allow a full cure prior to coating application as recommended by the patching compound manufacturer's recommendations.
- N. Polyvinyl Chloride (PVC) Pipe: remove contaminants and markings with denatured alcohol scuff sand and wipe with solvent for maximum adhesion. Test adhesion before starting the job.
- O. Fiberglass Doors - remove contaminants with cleaning solvent (alcohol) scuff sand and wipe. Test adhesion of primer before starting job.
- P. Textiles - Insulated Coverings, Canvas or Cotton: Clean using high-pressure air and solvent of type recommended for material.
- Q. Wood:
 1. Seal knots, pitch streaks, and sap areas with sealer recommended by coating manufacturer; fill nail recesses and cracks with filler recommended by coating manufacturer; sand surfaces smooth.
 2. Remove mill marks and ink stamped grade marks.
 3. Apply primer coat to back of wood trim and paneling.

- R. Wood Doors: Seal door tops and bottoms prior to finishing.
- S. Wood Doors - Field-Glazed Frames and Sash: Prime or seal glazing channels prior to glazing.

3.4. APPLICATION - GENERAL

- A. Application of primers, paints, stains or coatings, by the Contractor, will serve as acceptance that surfaces were properly prepared in accordance with the manufacturer's recommendation.
- B. Apply each coat to uniform coating thickness in accordance with manufacturer's instructions, not exceeding manufacturer's specified maximum spread rate for indicated surface; thins, brush marks, roller marks, orange-peel, or other application imperfections are not permitted.
- C. Allow manufacturer's specified drying time, and ensure correct coating adhesion, for each coat before applying next coat.
- D. Inspect each coat before applying next coat; touch-up surface imperfections with coating material, feathering, and sanding if required; touch-up areas to achieve flat, uniform surface without surface defects visible from 5 feet (1.5 m).
- E. Remove dust and other foreign materials from substrate immediately prior to applying each coat.
- F. Where paint application abuts other materials or other coating color, terminate coating with a clean sharp termination line without coating overlap.
- G. Where color changes occur between adjoining spaces, through framed openings that are of same color as adjoining surfaces, change color at outside stop corner nearest to face of closed door.
- H. Re-prepare and re-coat unsatisfactory finishes; refinish entire area to corners or other natural terminations.

3.5. CLEANING

- A. Clean excess coating materials, and coating materials deposited on surfaces not indicated to receive coatings, as construction activities of this section progress; do not allow to dry.
- B. Re-install hardware, electrical equipment plates, mechanical grilles and louvers, lighting fixture trim, and other items that have been removed to protect from contact with coatings.
- C. Reconnect equipment adjacent to surfaces indicated to receive coatings.
- D. Relocate to original position equipment and fixtures that have been moved to allow application of coatings.
- E. Remove protective materials.

3.6. PROTECTION AND REPAIR

- A. Protect completed coating applications from damage by subsequent construction activities until completion of painting project.
- B. Touch-up coatings damaged by subsequent construction activities.

END OF SECTION

TECHNICAL SPECIFICATIONS FOR GLENDALE FIRE STATION SECTION 10810 - TOILET ACCESSORIES

PART 1 - GENERAL

1.01 SYSTEM DESCRIPTION

- A. Design requirements: Meet ANSI A117.1 grab bar loading requirements.

PART 2 - PRODUCTS

2.01 MANUFACTURERS

- A. Toilet accessories:
 - 1. Acceptable manufacturers:
 - a. Products specified as standard of quality are manufactured by Bobrick Washroom Equipment, Inc., referred to as "Bobrick".
 - b. Products of manufacturers listed below meeting indicated standards and specified manufacturer's product data characteristics, except as modified below, are acceptable for use, subject to prior approval of proposed product list.
 - 1) American Specialties, Inc.
 - 2) Bradley Washfountain Company.
 - 2. Furnish accessories as product of one manufacturer, except where certain special items are indicated. Key keyed accessories alike with exception of coin receiving boxes on vending equipment. Key vending equipment in accord with Owner's requirements.
 - 3. Materials: Use AISI Type 304 stainless steel, (non-austenitic), for all parts except mounting kits for grab bars or specific items noted otherwise.
 - 4. Fasteners: Toilet and bath accessory manufacturer's recommended fasteners for substrate encountered.
 - 5. Toilet and bath accessories: Indicated on Drawings.
- B. Baby changing stations:
 - 1. Acceptable products:
 - a. American Infant Care Products; Diaper Deck□.
 - b. American Specialties, Inc.; 9010 Baby Changing Station.
 - c. Bobrick Washroom Equipment, Inc.; #B2200 Series.
 - d. JBJ Industries, Inc.; Koala Bear Kare Baby Changing Station.
 - 2. Characteristics:
 - a. Type: Surface mount fold down high impact FDA approved plastic unit with shaped platform for child's body.
 - b. Pneumatic gas shock assuring smooth operation of fold down platform.
 - c. Child safety strap on platform.
 - d. Furnish manufacturer's recommended wall anchors for substrates encountered.
 - e. Factory installed vandalism lock.

PART 3 - EXECUTION

3.01 EXAMINATION

- A. Verification of conditions:
 - 1. Verify built-in accessory plates and related items are in correct location and position.
 - 2. Check openings scheduled to receive recessed or semi-recessed accessories for correct dimensions, depth, plumbness of blocking for frames, and preparation affecting accessories installation.

**TECHNICAL SPECIFICATIONS FOR GLENDALE FIRE STATION
SECTION 10810 - TOILET ACCESSORIES**

3.02 INSTALLATION

A. General:

1. Built-in accessory plates: Furnish for installation under construction activities specified in other sections.
2. Install accessories level, plumb, in indicated locations.
3. Installation methods indicated in manufacturer's literature for substrates encountered.

B. Mounting heights, general:

1. Mount toilet and bath accessories where indicated.
2. If mounting heights are not indicated, mount at toilet and bath accessory manufacturer recommended height.
3. Accessory items indicated by code "*for use by the handicapped*": Mount at height required by ANSI A117.1 and ADA; use more restrictive requirement unless otherwise indicated in case of conflict.

C. Wall conditions, grab bars: Attach to stud wall system using accessory manufacturer supplied continuous length steel anchor plate and mounting kits at indicated locations on grab bar wall side.

D. Baby changing stations: Install on walls where indicated in accord with manufacturer's installation instructions at height required to meet ADA requirements.

E. Conceal evidence of drilling, cutting, and fitting adjacent finishes.

3.03 ADJUST AND CLEAN

A. Adjust accessories operating parts for correct operation.

B. Clean and polish exposed surfaces not more than 48 hours prior to Date of Substantial Completion.

C. Deliver accessory schedule, keys, and parts manual as part of Project Close-out documents.

END OF SECTION 10810

TECHNICAL SPECIFICATIONS FOR GLENDALE FIRE STATION
SECTION 12300 - FIRE EXTINGUISHERS, CABINETS AND ACCESSORIES

PART 1 - GENERAL

1.1 RELATED DOCUMENTS

- A. Drawings and general provisions of the Contract, including General and Supplementary Conditions and Division 1 Specification Sections, apply to this Section.

1.2 SUMMARY

- A. This Section includes the following:
 - Fire extinguishers.
 - Fire extinguisher cabinets.
 - Fire extinguisher mounting brackets.

1.3 SUBMITTALS

- A. General: Submit the following according to the Conditions of the Contract and Division 1 Specification Sections.
- B. Product data for cabinets include rough-in dimensions, details showing mounting methods, relationships of box and trim to surrounding construction, door hardware, cabinet type and materials, trim style, door construction, panel style, and materials.

1.4 QUALITY ASSURANCE

- A. Single-Source Responsibility: Obtain extinguishers and cabinets from one source from a single manufacturer.
- B. Coordination: Verify that cabinets are sized to accommodate type and capacity of extinguishers indicated and provided by Owner under separate Contract.
- C. UL-Listed Products: Fire extinguishers shall be UL listed with UL listing mark for type, rating, and classification of extinguisher.

PART 2 - PRODUCTS

2.1 MANUFACTURERS

- A. Available Manufacturers: Subject to compliance with requirements, manufacturers offering products that may be incorporated in the Work include,

TECHNICAL SPECIFICATIONS FOR GLENDALE FIRE STATION
SECTION 12300 - FIRE EXTINGUISHERS, CABINETS AND ACCESSORIES

but are not limited to, the following:

1. Manufacturers: Subject to compliance with requirements, provide products by one of the following:

Ansul Fire Protection.
Badger-Powhatan.
American Specialties Inc.
Bobrick Washroom Equipment, Inc.
Croker Div., Fire-End and Croker Corp.
Filtrine Manufacturing.
Lyon Metal Products.
J. L. Industries.
Larsen's Manufacturing Co.
Modem Metal Products by Muckle.
Potter-Roemer, Inc.
Samson Metal Products, Inc.

2.2 FIRE EXTINGUISHERS

- A. General: Provide fire extinguishers for indicated locations on life safety plan, in colors and finishes selected by Architect/Owner from manufacturer's standard, that comply with authorities having jurisdiction.

2.3 MOUNTING BRACKETS

- A. Brackets: Designed to prevent accidentally dislodging extinguisher, of sizes required for type and capacity of extinguisher indicated, in plated finish.

2.4 CABINETS

- A. Construction: Manufacturer's standard box, with trim, frame, door, and hardware to suit cabinet type, trim style, and door style indicated. Weld joints and grind smooth. Miter and weld perimeter door frames.
- B. Fire-Rated Cabinets: UL listed with UL listing mark with fire-resistance rating of wall where it is installed. Note that corridor walls or partitions have been designated with a fire rating as well as other areas within the buildings.

Cabinet Type: Suitable for containing the fire extinguisher.

Cabinet Mounting: Suitable for the following mounting conditions:

TECHNICAL SPECIFICATIONS FOR GLENDALE FIRE STATION
SECTION 12300 - FIRE EXTINGUISHERS, CABINETS AND ACCESSORIES

Semi-recessed: Cabinet box (tub) partially recessed in walls of shallow depth.

Trim Style: Fabricate trim in one piece with comers mitered, welded, and ground smooth.

Door Material and Construction: Manufacturer's standard door construction, of material indicated, coordinated with cabinet types and trim styles selected.

Aluminum-Backed Acrylic: Manufacturer's standard aluminum-backed obscure acrylic with silkscreen lettering or design applied to back of acrylic face.

Acrylic: Textured.

Identify fire extinguisher in cabinet with FIRE EXTINGUISHER lettering applied to door. Provide lettering to comply with authorities having jurisdiction for letter style, color, size, spacing, and location.

Application Process: Silk screen.

Identify bracket-mounted extinguishers with FIRE EXTINGUISHER in red letter decals applied to wall surface. Use letter size, style, and location as selected by Architect.

Door Style: Manufacturer's standard design with view panel.

Door Hardware: Provide manufacturer's standard door-operating hardware of proper type for cabinet type, trim style, and door material and style indicated. Provide either lever handle with earn-action latch, or exposed or concealed door pull and friction latch. Provide concealed or continuous-type hinge permitting door to open 180 deg.

2.5 FINISHES FOR CABINETS-GENERAL

- A. Comply with NAAMM "Metal Finishes Manual" for recommendations relative to applying and designating finishes.
- B. Protect mechanical finishes on exposed surfaces from damage by applying temporary strippable protective covering prior to shipping.

2.6 ALUMINUM CABINET FINISHES

- A. Finish designations prefixed by AA conform to the system established by the Aluminum Association for designating aluminum finishes.

TECHNICAL SPECIFICATIONS FOR GLENDALE FIRE STATION
SECTION 12300 - FIRE EXTINGUISHERS, CABINETS AND ACCESSORIES

- B. Class IT Clear Anodized Finish: AA-MI2C22A31 (Mechanical Finish: as fabricated, nonspecular; Chemical Finish: etched, medium matte; Anodic Coating: Class IT Architectural, clear film thicker than 0.4 mil).

PART 3 - EXECUTION

3.1 EXAMINATION

- A. Examine rough-in for hose vales, hose racks, and cabinets to verify locations of piping connections prior to cabinet installation.
- B. Examine walls and partitions for thickness and framing for cabinets to verify cabinet depth and mounting prior to cabinet installation.
- C. Do not proceed until unsatisfactory conditions have been corrected.

3.2 INSTALLATION

- A. Follow manufacturers printed instructions for installation.
- B. Install in locations and at mounting heights indicated or, if not indicated, at heights to comply with applicable regulations of governing authorities.
 - 1. Prepare recesses in walls for cabinets as required by type and size of cabinet and style of trim and to comply with manufacturers instructions.
 - 2. Fasten mounting brackets and cabinets to structure, square and plumb.

END OF SECTION 12300

TECHNICAL SPECIFICATIONS FOR GLENDALE FIRE STATION
SECTION 12366 – SOLID SURFACE COUNTERTOPS

PART 1 - GENERAL

1.1 RELATED DOCUMENTS

- A. Drawings and general provisions of the Contract, including General and Supplementary Conditions and Division 01 Specification Sections, apply to this Section.

1.2 SUMMARY

A. Section Includes:

1. Solid surface material countertops.
2. Solid surface vanities.
3. Solid surface material backsplashes.
4. Solid surface material end splashes.
5. Solid surface material apron fronts.
6. Solid surface material sinks.
7. Solid surface walls.
8. Solid surface window sills.
9. Solid surface adhesives and sealants.

B. Related Requirements:

1. Section 066400 "Plastic Paneling" for plastic paneling.
2. Section 224100 "Residential Plumbing Fixtures" for [non-integral sinks] [sinks] [and] [plumbing fittings].

1.3 ACTION SUBMITTALS

- A. Product Data: For countertop[, wall][, and][sill] materials[and sinks] including manufacturer's technical data sheets, and published written instructions.

B. Sustainable Design Submittals:

1. Product Data: For adhesives and sealants, indicating VOC content.
2. Laboratory Test Reports: For adhesives and sealants, indicating compliance with requirements for low-emitting materials.

- C. Shop Drawings: For countertops. Show materials, finishes, edge and backsplash profiles, methods of joining, terminations, and cutouts.

1. Show locations and details of joints.
2. Show direction of directional pattern, if any.

TECHNICAL SPECIFICATIONS FOR GLENDALE FIRE STATION
SECTION 12366 – SOLID SURFACE COUNTERTOPS

- D. Samples for Initial Selection: For each type of material exposed to view.
- E. Samples for Verification: For the following products:
 - 1. Countertop material, 6 inches square.
 - 2. Wood trim, 8 inches long.
 - 3. One full-size solid surface material countertop, with front edge of construction and in configuration specified.
- F. Certificates: For the following certifications:
 - 1. United States Food and Drug Administration (FDA) compliance for food contact materials described in 21 CFR 174 to 21 CFR 190.
 - 2. New York City material equipment acceptance, MEA 181-96-M.
 - 3. ANSI/NSF 51 "food zone" and FDA "direct-food contact" compliant.
 - 4. UL GREENGUARD® Gold Certified product for low-chemical emissions.

1.4 INFORMATIONAL SUBMITTALS

- A. Qualification Data: For manufacturer and fabricator.

1.5 CLOSEOUT SUBMITTALS

- A. Maintenance Data: For solid surface material countertops to include in maintenance manuals. Include Product Data for care products used or recommended by Installer and names, addresses, and telephone numbers of local sources for products.

1.6 QUALITY ASSURANCE

- A. Manufacturer Qualifications: ISO 9001 quality management system certification for manufacturing facility(ies).
- B. Fabricator Qualifications: Shop that employs skilled workers who custom-fabricate countertops similar to that required for this Project, and whose products have a record of successful in-service performance.
 - 1. Manufacturer-certified fabricator.
- C. Installer Qualifications: Manufacturer certified fabricator of countertops.
- D. Mockups: Build mockups to demonstrate aesthetic effects and to set quality standards for fabrication and installation.
 - 1. Build mockup of typical countertop as shown on Drawings.
 - 2. Subject to compliance with requirements, approved mockups may become part of the completed Work if undisturbed at time of Substantial Completion.

TECHNICAL SPECIFICATIONS FOR GLENDALE FIRE STATION
SECTION 12366 – SOLID SURFACE COUNTERTOPS

1.7 FIELD CONDITIONS

- A. Field Measurements: Verify dimensions of countertops by field measurements after base cabinets are installed but before countertop fabrication is complete.

1.8 COORDINATION

- A. Coordinate locations of utilities that will penetrate countertops or backsplashes.

1.9 WARRANTY

- A. Manufacturer's Warranty: Manufacturer and installer agree to repair or replace sheet material not free from defects in materials, fabrication, or workmanship within specified warranty period.
 - 1. Warranty Period: 10 years from date of Substantial Completion.

PART 2 - PRODUCTS

2.1 SOLID SURFACE COUNTERTOP AND WALL MATERIALS

- A. Composition Solid-Surface Material: Homogeneous-filled plastic resin complying with ICPA SS-1.
 - 1. Basis-of-Design Product: Subject to compliance with requirements, provide Wilsonart LLC; or a comparable product by one of the following:
 - a. Affinity Surfaces; a brand of Domain Industries, Inc.
 - b. Avonite Surfaces.
 - c. E. I. du Pont de Nemours and Company.
 - d. Formica Corporation.
 - e. LG Chemical, Ltd.
 - f. Meganite Inc.
 - g. Samsung Chemical USA, Inc.
 - h. Swan Corporation (The).
 - i. Transolid Div of Trumbull Industries.
 - 2. Thickness: 0.490 inch
 - 3. Panel Weight: 4.4 lb/sq. ft.
 - 4. Surface-Burning Characteristics: Comply with ASTM E 84; testing by a qualified testing agency. Identify products with appropriate markings of applicable testing agency.
 - a. Flame-Spread Index: [25] <Insert value> or less.
 - b. Smoke-Developed Index: [50] [450] <Insert value> or less.
 - 5. Colors and Patterns: As indicated by manufacturer's Economy designations.

TECHNICAL SPECIFICATIONS FOR GLENDALE FIRE STATION
SECTION 12366 – SOLID SURFACE COUNTERTOPS

2.2 COUNTERTOP FABRICATION

- A. Fabricate countertops according to solid surface material manufacturer's written instructions and to the AWI/AWMAC/WI's "Architectural Woodwork Standards."
 - 1. Grade: Economy.
- B. Configuration:
 - 1. Front: Straight, slightly eased at top
 - 2. Backsplash: Straight, slightly eased at corner
 - 3. End Splash: Matching backsplash.
- C. Countertops: 1/2-inch thick, solid surface material with front edge built up with same material.
- D. Backsplashes: 1/2-inch
- E. Fabricate tops with shop-applied edges and backsplashes unless otherwise indicated. Comply with solid surface material manufacturer's written instructions for adhesives, sealers, fabrication, and finishing.
 - 1. Fabricate with loose backsplashes for field assembly.
 - 2. Install integral sink bowls in countertops in the shop.
- F. Joints: Fabricate countertops without joints.
- G. Joints: Fabricate countertops in sections for joining in field
 - 1. Joint Locations: Not within 3 inches (76 mm) of a cutout or cooktop, 1 inch (25 mm) from inside corner for conventional seams, and not where countertop sections less than 36 inches (900 mm) long would result, unless unavoidable.
- H. Cutouts and Holes:
 - 1. Undercounter Plumbing Fixtures: Make cutouts for fixtures using template or pattern furnished by fixture manufacturer. Form cutouts to smooth, even curves.
 - a. Provide vertical edges, slightly eased at juncture of cutout edges with top and bottom surfaces of countertop.
 - b. Provide vertical edges, rounded to 3/8-inch radius at juncture of cutout edges with top surface of countertop, slightly eased at bottom.
 - 2. Counter-Mounted Plumbing Fixtures: Prepare countertops in shop for field cutting openings for counter-mounted fixtures. Mark tops for cutouts and drill holes at corners of cutout locations. Make corner holes of largest radius practical.
 - 3. Fittings: Drill countertops in shop for plumbing fittings, undercounter soap dispensers, and similar items.

TECHNICAL SPECIFICATIONS FOR GLENDALE FIRE STATION
SECTION 12366 – SOLID SURFACE COUNTERTOPS

4. Counter-Mounted Cooktops: Prepare countertops in shop for field cutting openings for cooktops. Mark tops for cutouts and drill holes at corners of cutout locations. Make corner holes of largest radius practical.

2.3 INSTALLATION MATERIALS

- A. Adhesive: Product recommended by solid surface material manufacturer.
 1. Adhesives shall have a VOC content of 70 g/L or less.
 2. Adhesive shall comply with the testing and product requirements of the California Department of Public Health's "Standard Method for the Testing and Evaluation of Volatile Organic Chemical Emissions from Indoor Sources Using Environmental Chambers."
- B. Sealant for Countertops: Comply with applicable requirements in Section 079200 "Joint Sealants."

PART 3 - EXECUTION

3.1 EXAMINATION

- A. Examine substrates to receive solid surface material countertops and conditions under which countertops will be installed, with Installer present, for compliance with requirements for installation tolerances and other conditions affecting performance of countertops.
- B. Proceed with installation only after unsatisfactory conditions have been corrected.

3.2 INSTALLATION

- A. Install countertops level to a tolerance of 1/8 inch in 8 feet, 1/4 inch maximum. Do not exceed 1/64-inch difference between planes of adjacent units.
- B. Fasten countertops by adhering with 100-percent silicone material in dab format (not bead format) to base units into underside of countertop at 18 to 24 inches o.c. Align adjacent surfaces and, using adhesive in color to match countertop, form seams to comply with manufacturer's written instructions. Carefully dress joints smooth, remove surface scratches, and clean entire surface.
- C. Fasten countertops by adhering with 100-percent silicone material in dab format (not bead format) to base units into underside of countertop at 18 to 24 inches (457 to 610 mm) o.c. Shim as needed to align subtops in a level plane.
- D. Secure countertops to subtops or wood-web frame with adhesive according to solid surface material manufacturer's written instructions. Align adjacent surfaces and, using adhesive in

TECHNICAL SPECIFICATIONS FOR GLENDALE FIRE STATION
SECTION 12366 – SOLID SURFACE COUNTERTOPS

color to match countertop, form seams to comply with manufacturer's written instructions. Carefully dress joints smooth, remove surface scratches, and clean entire surface.

- E. Bond joints with adhesive and draw tight as countertops are set. Mask areas of countertops adjacent to joints to prevent adhesive smears.
 - 1. Clamp units to temporary bracing, supports, or each other to ensure that countertops are properly aligned and joints are of specified width.
- F. Install backsplashes and end splashes by adhering to wall and countertops with adhesive. Mask areas of countertops and splashes adjacent to joints to prevent adhesive smears.
- G. Complete cutouts not finished in shop. Mask areas of countertops adjacent to cutouts to prevent damage while cutting. Make cutouts to accurately fit items to be installed, and at right angles to finished surfaces unless beveling is required for clearance. Ease edges slightly to prevent snipping.
- H. Apply sealant to gaps at walls

END OF SECTION 12366

TECHNICAL SPECIFICATIONS FOR GLENDALE FIRE STATION
SECTION 12370 – WOOD CABINETS

PART 1 - GENERAL

1.1 RELATED DOCUMENTS

- A. Drawings and general provisions of the Contract, including General and Supplementary Conditions and Division 01 Specification Sections, apply to this Section.

1.2 SUMMARY

- A. Section includes kitchen and vanity cabinets.
- B. Related Requirements:
 - 1. Section 06100 "Rough Carpentry" for wood blocking for anchoring casework.
 - 2. Section 12366 "Solid Surfacing Countertops."

1.3 DEFINITIONS

- A. Concealed Surfaces of Casework: Surfaces not usually visible after installation, including sleepers, web frames, dust panels, bottoms of drawers, and ends of casework installed directly against and completely concealed by walls or other casework, and tops of wall cabinets and utility cabinets.
- B. Exposed Surfaces of Casework: Surfaces visible when doors and drawers are closed, including visible surfaces in open cabinets or behind glass doors.
- C. Semiexposed Surfaces of Casework: Surfaces behind opaque doors or drawer fronts, including interior faces of doors, interiors and sides of drawers, and bottoms of wall cabinets.

1.4 COORDINATION

- A. Coordinate layout and installation of blocking and reinforcement in partitions for support of casework.

1.5 ACTION SUBMITTALS

- A. Product Data: For each type of product.
 - 1. Include construction details, material descriptions, dimensions of individual components, and profiles and finishes for casework.
 - 2. Include rated capacities, operating characteristics, profiles, and finishes for hardware.

TECHNICAL SPECIFICATIONS FOR GLENDALE FIRE STATION
SECTION 12370 – WOOD CABINETS

- B. Sustainable Design Submittals: none
- C. Shop Drawings:
 - 1. Include plans, elevations, details, and attachments to other work.
 - 2. Show materials, finishes, filler panels, and hardware.
 - 3. Indicate manufacturer's catalog numbers for casework.
- D. Samples: For casework and hardware finishes.
- E. Samples for Initial Selection: For casework and hardware finishes.
- F. Samples for Verification: For the following:
 - 1. Casework Finishes: 8-by-10-inch Samples for each type of casework finish.
 - 2. Hardware: One full-size Sample of each type of exposed hardware in each finish required.

1.6 INFORMATIONAL SUBMITTALS

- A. Qualification Data: For manufacturer.
- B. Product Certificates: For casework.

1.7 QUALITY ASSURANCE

- A. Manufacturer's Qualifications: Employs skilled workers who custom fabricate products similar to those required for this Project and whose products have a record of successful in-service performance.
 - 1. Manufacturer's Certification: Licensed participant in AWI's Quality Certification Program.
- B. Installer Qualifications: Manufacturer of products.

1.8 FIELD CONDITIONS

- A. Environmental Limitations: Do not deliver or install cabinets until building is enclosed, wet-work is complete, and HVAC system is operating and maintaining temperature between 60 and 90 deg F (16 and 32 deg C) and relative humidity between 25 and 55 percent during the remainder of the construction period.
- A. Field Measurements: Where cabinets are indicated to fit to other construction, verify dimensions of other construction by field measurements before fabrication, and indicate measurements on Shop Drawings. Coordinate fabrication schedule with construction progress to avoid delaying the Work.

TECHNICAL SPECIFICATIONS FOR GLENDALE FIRE STATION
SECTION 12370 – WOOD CABINETS

1. Locate concealed framing, blocking, and reinforcements that support cabinets by field measurements before being enclosed/concealed by construction, and indicate measurements on Shop Drawings.
- B. Field Measurements: Where casework is indicated to fit to existing construction, verify dimensions of existing construction by field measurements before fabrication and indicate measurements on Shop Drawings. Provide fillers and scribes to allow for trimming and fitting.
- C. Locate concealed framing, blocking, and reinforcements that support casework by field measurements before enclosing them, and indicate measurements on Shop Drawings.

PART 2 - PRODUCTS

2.1 CABINETS

- A. Quality Standard: Unless otherwise indicated, comply with the Architectural Woodwork Standards for grades of architectural cabinets indicated for construction, finishes, installation, and other requirements.
 1. Provide labels from AWI certification program indicating that woodwork complies with requirements of grades specified.
 2. The Contract Documents contain requirements that are more stringent than the referenced woodwork quality standard. Comply with requirements of Contract Documents in addition to those of the referenced quality standard.
- B. Quality Standard: Provide cabinets that comply with KCMA A161.1.
 1. KCMA Certification: Provide cabinets with KCMA's "Certified Cabinet" seal affixed in a semiexposed location of each unit and showing compliance with KCMA A161.1.
- C. Door and Drawer Face Style: Flush Overlay
 1. Door and Drawer Fronts: Solid-wood stiles and rails, 5/8 inch thick, with 3/4-inch- thick, solid-wood center panels.
- D. Cabinet Style: Face Frame
 1. Face Frames: 3/4-by-1-5/8-inch solid wood with glued mortise and tenon or doweled joints.
 - 2.
- E. Exposed Cabinet End Finish: Must match material and look of cabinet fronts and doors
- F. Cabinet End Construction: 3/8-inch- thick plywood.

TECHNICAL SPECIFICATIONS FOR GLENDALE FIRE STATION
SECTION 12370 – WOOD CABINETS

- G. Cabinet Tops and Bottoms: 3/8-inch thick plywood.
 - 1. Fully support in rabbets in and secure to end panels, front frame, and back rail.
- H. Back, Top, and Bottom Rails: 3/4-by-2-1/2-inch solid wood, interlocking with end panels and rabbeted to receive top and bottom panels. Back rails secured under pressure with glue and with mechanical fasteners.
- I. Wall-Hung-Unit Back Panels: 3/16-inch thick plywood fastened to rear edge of end panels and to top and bottom rails.
- J. Base-Unit Back Panels: 3/16-inch thick plywood fastened to rear edge of end panels and to top and bottom rails.
- K. Front Frame Drawer Rails: 3/4-by-1-1/4-inch solid wood mortised and fastened into face frame.
- L. Drawers: Fabricate with exposed fronts fastened to subfront with mounting screws from interior of body.
 - 1. Join subfronts, backs, and sides with glued dovetail joints.
 - 2. Subfronts, Backs, and Sides: 1/2-inch thick solid wood or 3/8-inch thick plywood.
 - 3. Bottoms: 1/4-inch thick plywood
- M. Shelves: plywood.
- N. Joinery: Rabbet backs flush into end panels and secure with concealed mechanical fasteners. Connect tops and bottoms of wall cabinets and bottoms and stretchers of base cabinets to ends and dividers with mechanical fasteners. Rabbet tops, bottoms, and backs into end panels.
- O. Factory Finishing: Finish cabinets at factory.

2.2 CABINET MATERIALS

- A. Hardwood Lumber: Kiln dried to 7 percent moisture content.
- B. Softwood Lumber: Kiln dried to 10 percent moisture content.
- C. Hardwood Plywood: HPVA HP-1.
- D. Exposed Materials:
 - 1. Exposed Wood Species: Oak
 - a. Select materials for compatible color and grain. Do not use two adjacent exposed surfaces that are noticeably dissimilar in color, grain, figure, or natural character markings.
 - b. Staining and Finish: As selected by Engineer from manufacturer's full range.

TECHNICAL SPECIFICATIONS FOR GLENDALE FIRE STATION
SECTION 12370 – WOOD CABINETS

2. Solid Wood: Clear hardwood lumber of species indicated, free of defects.
3. Plywood: Hardwood plywood with face veneer of species indicated, with Grade A faces and Grade C backs of same species as faces.
 - a. Edge band exposed edges with a minimum of 1/8-inch thick, solid-wood edging of same species as face veneer.

E. Semiexposed Materials: Unless otherwise indicated, provide the following:

1. Solid Wood: Sound hardwood lumber, selected to eliminate appearance defects. Same species as exposed surfaces or stained to be compatible with exposed surfaces.

F. Concealed Materials: Solid wood or plywood, of any hardwood or softwood species, with no defects affecting strength or utility

2.3 CABINET HARDWARE

A. General: Manufacturer's standard units complying with BHMA A156.9, of type, size, style, material, and finish as selected by Architect from manufacturer's full range

B. Pulls: Back-Mounted Pulls: BHMA A156.9,:

1. Richelieu, Transitional Metal Pull #815
 - a. Polished Nickel, 4 3/16"

C. Hinges: Frameless Concealed Hinges (European Type): BHMA A156.9, B01602, 135 degrees of opening.

D. Adjustable Shelf Standards and Supports: BHMA A156.9, B04071; with shelf rests, B04081.

E. Shelf Rests: BHMA A156.9, B04013; single-pin metal.

F. Drawer Slides: BHMA A156.9.

1. Grade 1 and Grade 2: Side mounted.
 - a. Type: Full extension.
 - b. Material: Zinc-plated steel with polymer rollers.
2. Grade 1HD-100 and Grade 1HD-200: Side mounted; full-extension type; zinc-plated-steel, ball-bearing slides.
3. For drawers not more than 3 inches (75 mm) high and not more than 24 inches (600 mm) wide, provide Grade 2.
4. For drawers more than 3 inches (75 mm) high, but not more than 6 inches (150 mm) high and not more than 24 inches (600 mm) wide, provide Grade 1.
5. For drawers more than 6 inches (150 mm) high or more than 24 inches (600 mm) wide, provide Grade 1HD-200.

TECHNICAL SPECIFICATIONS FOR GLENDALE FIRE STATION
SECTION 12370 – WOOD CABINETS

6. For trash bins not more than 20 inches (500 mm) high and 16 inches (400 mm) wide, provide Grade 1HD-200.
- G. Door and Drawer Bumpers: Self-adhering, clear silicone rubber.
 1. Doors: Provide one bumper at top and bottom of closing edge of each swinging door.
 2. Drawers: Provide one bumper on back side of drawer front at each corner.

PART 3 - EXECUTION

3.1 EXAMINATION

- A. Examine areas, with Installer present, for compliance with requirements for installation tolerances, location of framing and reinforcements, and other conditions affecting performance of casework.
- B. Proceed with installation only after unsatisfactory conditions have been corrected.

3.2 INSTALLATION

- A. Install casework with no variations in adjoining surfaces; use concealed shims. Where casework abuts other finished work, scribe and cut for accurate fit. Provide filler strips, scribe strips, and moldings in finish to match casework.
- B. Install casework without distortion so doors and drawers fit the openings, are aligned, and are uniformly spaced. Complete installation of hardware and accessories as indicated.
- C. Install casework level and plumb to a tolerance of 1/8 inch in 8 feet.
- D. Fasten casework to adjacent units and to backing.
 1. Fasten wall cabinets through back, near top and bottom, and at ends not more than 16 inches o.c.
 - a. Fasteners: No. 10 wafer-head screws sized for not less than 1-1/2-inch penetration into wood framing, blocking, or hanging strips.

3.3 ADJUSTING AND CLEANING

- A. Adjust hardware so doors and drawers are centered in openings and operate smoothly without warp or bind. Lubricate operating hardware as recommended by manufacturer.
- B. Clean casework on exposed and semiexposed surfaces. Touch up as required to restore damaged or soiled areas to match original factory finish, as approved by Architect.

END OF SECTION 12370

TECHNICAL SPECIFICATIONS FOR GLENDALE FIRE STATION
SECTION 12375 – WOOD VENEER CABINETS

PART 1 - GENERAL

1.1 RELATED DOCUMENTS

- A. Drawings and general provisions of the Contract, including General and Supplementary Conditions and Division 01 Specification Sections, apply to this Section.

1.2 SUMMARY

A. Section Includes:

1. Wood-veneer-faced architectural cabinets.
2. Wood furring, blocking, shims, and hanging strips for installing architectural cabinets that are not concealed within other construction.
3. Shop finishing of architectural cabinets.

B. Related Requirements:

1. Section 06100 " Rough Carpentry" for wood furring, blocking, shims, and hanging strips required for installing cabinets that are concealed within other construction before cabinet installation.

1.3 COORDINATION

- A. Coordinate sizes and locations of framing, blocking, furring, reinforcements, and other related units of Work specified in other Sections to support loads imposed by installed and fully loaded cabinets.

1.4 PREINSTALLATION MEETINGS

- A. Preinstallation Conference: Conduct conference at Project site.

1.5 ACTION SUBMITTALS

A. Product Data: For each type of product.

1. Include data for fire-retardant treatment from chemical-treatment manufacturer and certification by treating plant that treated materials comply with requirements.

B. Sustainable Design Submittals:

TECHNICAL SPECIFICATIONS FOR GLENDALE FIRE STATION
SECTION 12375 – WOOD VENEER CABINETS

1. Product Data: For recycled content, indicating postconsumer and preconsumer recycled content and cost.
 2. Product Certificates: For materials manufactured within 100 miles (160 km) of Project, indicating location of material manufacturer and point of extraction, harvest, or recovery for each raw material. Include distance to Project and cost for each raw material.
 3. Chain-of-Custody Certificates: For certified wood products. Include statement of costs.
 4. Laboratory Test Reports: For adhesives, indicating compliance with requirements for low-emitting materials.
 5. Laboratory Test Reports: For composite wood products, indicating compliance with requirements for low-emitting materials.
- C. Shop Drawings: For architectural cabinets.
1. Include plans, elevations, sections, and attachment details.
 2. Show large-scale details.
 3. Show locations and sizes of furring, blocking, and hanging strips, including concealed blocking and reinforcement specified in other Sections.
 4. Show locations and sizes of cutouts and holes for items installed in architectural cabinets.
 5. Show veneer leaves with dimensions, grain direction, exposed face, and identification numbers indicating the flitch and sequence within the flitch for each leaf.
 6. Apply AWI Quality Certification Program label to Shop Drawings.
- D. Samples: For each exposed product and for each color and finish specified, in manufacturer's standard size.
- E. Samples for Initial Selection: For each type of exposed finish.
- F. Samples for Verification: For the following:
1. Thermoset Decorative Panels: 8 by 10 inches (200 by 250 mm), for each color, pattern, and surface finish.
 - a. Provide edge banding on one edge.
 2. Exposed Cabinet Hardware and Accessories: One full-size unit for each type and finish.
- 1.6 INFORMATIONAL SUBMITTALS
- A. Qualification Data: For manufacturer and Installer.
- B. Product Certificates: For each type of product.
1. Composite wood and agrifiber products.
 2. Thermoset decorative panels.
 3. Adhesives.
- C. Evaluation Reports: For fire-retardant-treated materials, from ICC-ES.

TECHNICAL SPECIFICATIONS FOR GLENDALE FIRE STATION
SECTION 12375 – WOOD VENEER CABINETS

- D. Field quality-control reports.

1.7 CLOSEOUT SUBMITTALS

- A. Quality Standard Compliance Certificates: AWI Quality Certification Program certificates.

1.8 QUALITY ASSURANCE

- A. Manufacturer's Qualifications: Employs skilled workers who custom fabricate products similar to those required for this Project and whose products have a record of successful in-service performance.

- 1. Manufacturer's Certification: Licensed participant in AWI's Quality Certification Program.

- B. Installer Qualifications: Manufacturer of products.

1.9 DELIVERY, STORAGE, AND HANDLING

- A. Do not deliver cabinets until painting and similar finish operations that might damage architectural cabinets have been completed in installation areas. Store cabinets in installation areas or in areas where environmental conditions comply with requirements specified in "Field Conditions" Article.

1.10 FIELD CONDITIONS

- A. Environmental Limitations: Do not deliver or install cabinets until building is enclosed, wet-work is complete, and HVAC system is operating and maintaining temperature between 60 and 90 deg F (16 and 32 deg C) and relative humidity between 25 and 55 percent during the remainder of the construction period.

- B. Field Measurements: Where cabinets are indicated to fit to other construction, verify dimensions of other construction by field measurements before fabrication, and indicate measurements on Shop Drawings. Coordinate fabrication schedule with construction progress to avoid delaying the Work.

- 1. Locate concealed framing, blocking, and reinforcements that support cabinets by field measurements before being enclosed/concealed by construction, and indicate measurements on Shop Drawings.

- C. Established Dimensions: Where cabinets are indicated to fit to other construction, establish dimensions for areas where cabinets are to fit. Provide allowance for trimming at site, and coordinate construction to ensure that actual dimensions correspond to established dimensions.

TECHNICAL SPECIFICATIONS FOR GLENDALE FIRE STATION
SECTION 12375 – WOOD VENEER CABINETS

PART 2 - PRODUCTS

2.1 CABINETS, GENERAL

- A. Quality Standard: Unless otherwise indicated, comply with the Architectural Woodwork Standards for grades of architectural cabinets indicated for construction, finishes, installation, and other requirements.
1. Provide labels from AWI certification program indicating that woodwork complies with requirements of grades specified.
 2. The Contract Documents contain requirements that are more stringent than the referenced woodwork quality standard. Comply with requirements of Contract Documents in addition to those of the referenced quality standard.

2.2 WOOD CABINETS FOR TRANSPARENT FINISH

- A. Architectural Woodwork Standards Grade: Premium.
- B. Regional Materials: Wood products shall be manufactured within 100 miles (160 km) of Project site from materials that have been extracted, harvested, or recovered, as well as manufactured, within 100 miles (160 km) of Project site.
- C. Certified Wood: Wood products shall be certified as "FSC Pure" or "FSC Mixed Credit" according to FSC STD-01-001 and FSC STD-40-004.
- D. Type of Construction: Frameless.
- E. Door and Drawer-Front Style: Flush overlay.
- F. Wood for Exposed Surfaces:
1. Species: Select White Maple.
 2. Cut: Plain sliced/plain sawn.
 3. Grain Direction: Vertically for doors and fixed panels, horizontally for drawer fronts.
 4. Matching of Veneer Leaves: Slip match.
 5. Veneer Matching within Panel Face: Center-balance match.
 6. Veneer Matching within Room: Pleasingly matched for color and grain.
- G. Semiexposed Surfaces:
1. Surfaces Other Than Drawer Bodies: Thermoset decorative panels.
 - a. Edges of Thermoset Decorative Panel Shelves: PVC or polyester edge banding.
 2. Drawer Subfronts, Backs, and Sides: Thermoset decorative panels with PVC or polyester edge banding.

TECHNICAL SPECIFICATIONS FOR GLENDALE FIRE STATION
SECTION 12375 – WOOD VENEER CABINETS

3. Drawer Bottoms: Hardwood plywood or Thermoset decorative panels.
- H. Drawer Construction: Fabricate with exposed fronts fastened to subfront with mounting screws from interior of body.
 1. Join subfronts, backs, and sides with glued rabbeted joints supplemented by mechanical fasteners.

2.3 WOOD MATERIALS

- A. Wood Products: Provide materials that comply with requirements of referenced quality standard for each type of architectural cabinet and quality grade specified unless otherwise indicated.
 1. Do not use plain-sawn softwood lumber with exposed, flat surfaces more than 3 inches wide.
 2. Wood Moisture Content: 8 to 13 percent.
- B. Composite Wood and Agrifiber Products: Provide materials that comply with requirements of referenced quality standard for each type of architectural cabinet and quality grade specified unless otherwise indicated.
 1. Recycled Content of MDF and Particleboard: Postconsumer recycled content plus one-half of preconsumer recycled content not less than 25 percent.
- C. Composite Wood Products: Products shall be made using ultra-low-emitting formaldehyde resins as defined in the California Air Resources Board's "Airborne Toxic Control Measure to Reduce Formaldehyde Emissions from Composite Wood Products" or shall be made with no added formaldehyde.
 1. MDF: ANSI A208.2, Grade 130.
 2. Particleboard: ANSI A208.1, Grade M-2.
 3. Particleboard: Straw-based particleboard complying with requirements in ANSI A208.1, Grade M-2, except for density.
 - a. Products: Subject to compliance with requirements, provide one of the following:
 - 1) Environ Biocomposites Manufacturing LLC; Biofiber Wheat.
 - 2) Sorm Incorporated; Primeboard Premium Wheat.
 4. Softwood Plywood: DOC PS 1, medium-density overlay.
 5. Veneer-Faced Panel Products (Hardwood Plywood): HPVA HP-1.
 6. Thermoset Decorative Panels: Particleboard or MDF finished with thermally fused, melamine-impregnated decorative paper and complying with requirements of NEMA LD 3, Grade VGL, for Test Methods 3.3, 3.4, 3.6, 3.8, and 3.10.

TECHNICAL SPECIFICATIONS FOR GLENDALE FIRE STATION
SECTION 12375 – WOOD VENEER CABINETS

2.4 CABINET HARDWARE AND ACCESSORIES

- A. General: Provide cabinet hardware and accessory materials associated with architectural cabinets except for items specified in Section 087100 "Door Hardware."
- B. Frameless Concealed Hinges (European Type): BHMA A156.9, B01602, 135 degrees of opening.
- C. Back-Mounted Pulls: BHMA A156.9;
 - 1. Richelieu, Contemporary Metal Pull #873
 - a. Polished Nickel, 4 3/16"
- D. Adjustable Shelf Standards and Supports: BHMA A156.9, B04071; with shelf rests, B04081.
- E. Shelf Rests: BHMA A156.9, B04013; single-pin metal.
- F. Drawer Slides: BHMA A156.9.
 - 1. Grade 1 and Grade 2: Side mounted.
 - a. Type: Full extension.
 - b. Material: Zinc-plated steel with polymer rollers.
 - 2. Grade 1HD-100 and Grade 1HD-200: Side mounted; full-extension type; zinc-plated-steel, ball-bearing slides.
 - 3. For drawers not more than 3 inches (75 mm) high and not more than 24 inches (600 mm) wide, provide Grade 2.
 - 4. For drawers more than 3 inches (75 mm) high, but not more than 6 inches (150 mm) high and not more than 24 inches (600 mm) wide, provide Grade 1.
 - 5. For drawers more than 6 inches (150 mm) high or more than 24 inches (600 mm) wide, provide Grade 1HD-200.
 - 6. For computer keyboard shelves, provide Grade 1.
 - 7. For trash bins not more than 20 inches (500 mm) high and 16 inches (400 mm) wide, provide Grade 1HD-200.
- G. Door Locks: BHMA A156.11, E07121.
- H. Drawer Locks: BHMA A156.11, E07041.
- I. Door and Drawer Silencers: BHMA A156.16, L03011.
- J. Grommets for Cable Passage: 2-inch (51-mm) OD, molded-plastic grommets and matching plastic caps with slot for wire passage.
 - 1. Color: As selected by Architect.
- K. Exposed Hardware Finishes: For exposed hardware, provide finish that complies with BHMA A156.18 for BHMA finish number indicated.

TECHNICAL SPECIFICATIONS FOR GLENDALE FIRE STATION
SECTION 12375 – WOOD VENEER CABINETS

1. Satin Chromium Plated: BHMA 626 for brass or bronze base; BHMA 652 for steel base.
- L. For concealed hardware, provide manufacturer's standard finish that complies with product class requirements in BHMA A156.9.

2.5 MISCELLANEOUS MATERIALS

- A. Furring, Blocking, Shims, and Hanging Strips: Softwood or hardwood lumber, kiln-dried to less than 15 percent moisture content.
- B. Anchors: Select material, type, size, and finish required for each substrate for secure anchorage. Provide metal expansion sleeves or expansion bolts for post-installed anchors. Use nonferrous-metal or hot-dip galvanized anchors and inserts at inside face of exterior walls and at floors.
- C. Adhesives: Use adhesives that meet the testing and product requirements of the California Department of Public Health's "Standard Method for the Testing and Evaluation of Volatile Organic Chemical Emissions from Indoor Sources Using Environmental Chambers."

2.6 FABRICATION

- A. Sand fire-retardant-treated wood lightly to remove raised grain on exposed surfaces before fabrication.
- B. Fabricate architectural cabinets to dimensions, profiles, and details indicated. Ease edges and corners to 1/16-inch radius unless otherwise indicated.
- C. Complete fabrication, including assembly and hardware application, to maximum extent possible before shipment to Project site. Disassemble components only as necessary for shipment and installation. Where necessary for fitting at site, provide ample allowance for scribing, trimming, and fitting.
 1. Notify Architect seven days in advance of the dates and times architectural cabinet fabrication will be complete.
 2. Trial fit assemblies at manufacturer's shop that cannot be shipped completely assembled. Install dowels, screws, bolted connectors, and other fastening devices that can be removed after trial fitting. Verify that various parts fit as intended and check measurements of assemblies against field measurements before disassembling for shipment.
- D. Shop-cut openings to maximum extent possible to receive hardware, appliances, electrical work, and similar items. Locate openings accurately and use templates or roughing-in diagrams to produce accurately sized and shaped openings. Sand edges of cutouts to remove splinters and burrs.

TECHNICAL SPECIFICATIONS FOR GLENDALE FIRE STATION
SECTION 12375 – WOOD VENEER CABINETS

2.7 SHOP FINISHING

- A. General: Finish architectural cabinets at manufacturer's shop as specified in this Section. Defer only final touchup, cleaning, and polishing until after installation.
- B. General: Shop finish transparent-finished architectural cabinets at manufacturer's shop as specified in this Section.
- C. Preparation for Finishing: Comply with referenced quality standard for sanding, filling countersunk fasteners, sealing concealed surfaces, and similar preparations for finishing architectural cabinets, as applicable to each unit of work.
 - 1. Backpriming: Apply one coat of sealer or primer, compatible with finish coats, to concealed surfaces of cabinets.
- D. Transparent Finish:
 - 1. Architectural Woodwork Standards Grade: Premium.
 - 2. Finish: System - 11, catalyzed polyurethane.
 - 3. Wash Coat for Closed-Grain Woods: Apply wash-coat sealer to cabinets made from closed-grain wood before staining and finishing.
 - 4. Staining: Match approved sample for color.
 - 5. Sheen: Satin, 31-45 gloss units measured on 60-degree gloss meter per ASTM D 523.

PART 3 - EXECUTION

3.1 PREPARATION

- A. Before installation, condition cabinets to humidity conditions in installation areas for not less than 72 hours.

3.2 INSTALLATION

- A. Architectural Woodwork Standards Grade: Install cabinets to comply with quality standard grade of item to be installed.
- B. Assemble cabinets and complete fabrication at Project site to extent that it was not completed in the shop.
- C. Anchor cabinets to anchors or blocking built in or directly attached to substrates. Secure with countersunk, concealed fasteners and blind nailing. Use fine finishing nails for exposed fastening, countersunk and filled flush with cabinet surface.
 - 1. For shop-finished items, use filler matching finish of items being installed.

TECHNICAL SPECIFICATIONS FOR GLENDALE FIRE STATION
SECTION 12375 – WOOD VENEER CABINETS

- D. Install cabinets level, plumb, and true in line to a tolerance of 1/8 inch in 96 inches using concealed shims.
 - 1. Scribe and cut cabinets to fit adjoining work, refinish cut surfaces, and repair damaged finish at cuts.
 - 2. Install cabinets without distortion so doors and drawers fit openings and are accurately aligned. Adjust hardware to center doors and drawers in openings and to provide unencumbered operation. Complete installation of hardware and accessory items as indicated.
 - 3. Maintain veneer sequence matching of cabinets with transparent finish.
 - 4. Fasten wall cabinets through back, near top and bottom, and at ends not more than 16 inches o.c. with No. 10 wafer-head screws sized for not less than 1-1/2-inch penetration into wood framing, blocking, or hanging strips.

- E. Shop Finishes: Touch up finishing after installation of architectural cabinets. Fill nail holes with matching filler.
 - 1. Apply specified finish coats, including stains and paste fillers if any, to exposed surfaces where only sealer/prime coats are shop applied.

3.3 ADJUSTING AND CLEANING

- A. Repair damaged and defective cabinets, where possible, to eliminate functional and visual defects. Where not possible to repair, replace architectural cabinets. Adjust joinery for uniform appearance.
- B. Clean, lubricate, and adjust hardware.
- C. Clean cabinets on exposed and semiexposed surfaces. Touch up finishes to restore damaged or soiled areas.

END OF SECTION 12375

SECTION 13000
METAL BUILDING SYSTEMS

PART 1 - GENERAL

1.1 SECTION INCLUDES:

- A. Metal building systems including:
 - 1. Metal framing components.
 - 2. Metal wall panels and trim.
 - 3. Metal roof panels and trim.
 - 4. Metal building accessories.

1.2 RELATED SECTIONS:

- A. Section 07 90 10 - Joint Sealants
- B. Section 03 30 00 - Cast-In-Place Concrete
- C. Section 05 12 00 - Structural Steel
- D. Section 05 40 00 - Cold-Formed Metal Framing
- E. Section 07 41 60 - Standing Seam Metal Roof System

1.3 REFERENCES

- A. American Institute of Steel Construction (AISC):
 - 1. AISC 360 - Specification for Structural Steel Buildings, June 22, 2010.
 - 2. AISC 341 - AISC Seismic Provisions for Structural Steel Buildings, June 22nd, 2010.
 - 3. AISC 303 - Code of Standard Practice for Steel Buildings and Bridges, April 14th, 2010.
- B. American Iron and Steel Institute (AISI) :
 - 1. AISI S100 - North American Specification for the Design of Cold-Formed Steel Structural Members, 2012 Edition.
- C. American Welding Society (AWS)
 - 1. AWS D1.1/D1.1M - Structural Welding Code - Steel, 2010.
 - 2. AWS D1.3/D1.3M - Structural Welding Code - Sheet Steel, 2008
- D. American Society of Heating, Refrigeration and Air Conditioning Engineers (ASHRAE):
 - 1. ASHRAE 90.1-2013 - Energy Standard for Buildings Except Low-Rise Residential Buildings (I-P Edition).
- E. ASTM International (ASTM): Latest versions of:
 - 1. ASTM A 36/A 36M - Standard Specification for Carbon Structural Steel.
 - 2. ASTM A 475 - Standard Specification for Zinc-Coated Steel Wire Strand.
 - 3. ASTM A 500/A 500M - Standard Specification for Cold-Formed Welded and Seamless Carbon Steel Structural Tubing in Rounds and Shapes.
 - 4. ASTM A 529/A 529M - Standard Specification for High-Strength Carbon-Manganese Steel of Structural Quality.
 - 5. ASTM A 563 - Standard Specification for Carbon and Alloy Steel Nuts.

6. ASTM A 572/A 572M - Standard Specification for High-Strength Low-Alloy Columbium-Vanadium Structural Steel.
7. ASTM A 653/A 653M - Standard Specification for Steel Sheet, Zinc-Coated (Galvanized) or Zinc-Iron Alloy-Coated (Galvannealed) by the Hot-Dip Process.
8. ASTM A 792/A 792M - Standard Specification for Steel Sheet, 55 Percent Aluminum-Zinc Alloy-Coated by Hot-Dip Process.
9. ASTM A 992/A 992M - Standard Specification for Structural Steel Shapes.
10. ASTM A 1011/A 1011M - Standard Specification for Steel, Sheet and Strip, Hot-Rolled, Carbon, Structural, High-Strength, Low-Alloy and High-Strength Low-Alloy with Improved Formability and Ultra-High Strength
11. ASTM A 1018/A 1018A - Standard Specification for Steel, Sheet and Strip, Heavy-Thickness Coils, Hot-Rolled, Carbon, Commercial, Drawing, Structural, High-Strength Low-Alloy, High-Strength Low-Alloy with Improved Formability, and Ultra-High Strength
12. ASTM C 518 - Standard Test Method for Steady-State Thermal Transmission Properties by Means of the Heat Flow Meter Apparatus.
13. ASTM C 1363 - Standard Test Method for Thermal Performance of Building Materials and Envelope Assemblies by Means of a Hot Box Apparatus.
14. ASTM D 635 - Standard Test Method for Rate of Burning and/or Extent and Time of Burning of Plastics in a Horizontal Position.
15. ASTM D 1003 - Standard Test Method for Haze and Luminous Transmittance of Transparent Plastics.
16. ASTM D 1494 - Standard Test Method for Diffuse Light Transmission Factor of Reinforced Plastics Panels.
17. ASTM D 1929 - Standard Test Method for Determining Ignition Temperature of Plastics.
18. ASTM D 2240 - Standard Test Method for Rubber Property—Durometer Hardness.
19. ASTM D 2244 - Standard Practice for Calculation of Color Tolerances and Color Differences from Instrumentally Measured Color Coordinates.
20. ASTM D 4214 - Standard Test Methods for Evaluating the Degree of Chalking of Exterior Paint Films.
21. ASTM E 84 - Standard Test Method for Surface Burning Characteristics of Building Materials.
22. ASTM E 72 - Standard Test Methods of Conducting Strength Tests of Panels for Building Construction.
23. ASTM E 283 - Standard Test Method for Determining Rate of Air Leakage through Exterior Windows, Curtain Walls, and Doors under Specified Pressure Differences Across Specimen.
24. ASTM E 331 - Standard Test Method for Water Penetration of Exterior Windows, Skylights, Doors, and Curtain Walls by Uniform Static Air Pressure Difference.
25. ASTM E 1592 - Standard Test Method for Structural Performance of Sheet Metal Roof and Siding Systems by Uniform Static Air Pressure Difference.
26. ASTM E 1646 - Standard Test Method for Water Penetration of Exterior Metal Roof Panel Systems by Uniform Static Air Pressure Difference.
27. ASTM E 1680 - Standard Test Method for Rate of Air Leakage Through Exterior Metal Roof Panel Systems.
28. ASTM E 1980 - Standard Practice for Calculating Solar Reflectance Index of Horizontal and Low-Sloped Opaque Surfaces.
29. ASTM F 436 - Standard Specification for Hardened Steel Washers
30. ASTM F 1941 - Standard Specification for Electrodeposited Coatings on Threaded Fasteners (Unified Inch Screw Threads (UN/UNR))
31. ASTM F 3125 - Standard Specification for High Strength Structural Bolts, Steel and Alloy Steel, Heat Treated, 120 ksi (830 MPa) and 150 ksi (1040 MPa) Minimum Tensile Strength, Inch and Metric Dimensions.

F. Cool Roof Rating Council (CRRC):

1. ANSI/CRRC S100 - Standard Test Methods for Determining Radiative Properties of Materials, April 26th, 2016.
- G. Factory Mutual Approvals (FM Approvals):
1. FM 4471 - Approval Standard for Class 1 Panel Roofs.
 2. FM 4880 - Approval Standard for Class 1 Fire Rating of Insulated Wall or Wall and Roof/Ceiling Panels, Interior Finish Materials or Coatings and Exterior Wall Systems.
 3. FM 4881 - Approval Standard for Class 1 Exterior Wall Systems.
- H. FM Global:
1. FM 1-28 – Property Loss Prevention Data Sheet 1-28, Wind Design, October 2015.
- I. International Accreditation Service (IAS):
1. Accreditation Criteria 472 (AC472) - Accreditation Criteria for Inspection Programs for Manufacturers of Metal Building Systems, April 2017
- J. International Standards Organization (ISO)
1. ISO 14044 - Environmental management -- Life Cycle Assessment -- Requirements and Guidelines, 2006
 2. ISO 21930 - Sustainability in Building Construction -- Environmental Declaration of Building Products, 2007.
- K. Metal Building Manufacturers Association (MBMA):
1. Metal Building Systems Manual, 2012 Edition.
- L. National Fenestration Rating Council (NFRC):
1. NFRC 100 - Procedure for Determining Fenestration Product U-factors, 2014
 2. NFRC 200 - Procedure for Determining Fenestration Product Solar Heat Gain Coefficient and Visible Transmittance at Normal Incidence, 2010.
- M. National Fire Protection Association (NFPA):
1. NFPA 285 - Standard Fire Test Method for Evaluation of Fire Propagation Characteristics of Exterior Non-Load-Bearing Wall Assemblies Containing Combustible Components, 2012 Edition.
- N. Research Council on Structural Connections (RCSC):
1. Specification for Structural Joints Using High Strength Bolts, August 1, 2014.
- O. Underwriters Laboratories (UL):
1. UL-580 - Tests for Uplift Resistance of Roof Assemblies.
 2. UL-790 - Standard Test Methods for Fire Tests of Roof Coverings.
 3. UL-2218 - Impact Resistance of Prepared Roof Covering Materials.

1.4 ADMINISTRATIVE REQUIREMENTS

- A. Pre-installation Meeting: Prior to erection of framing, conduct pre-installation meeting at site attended by Owner, Architect, manufacturer's technical representative, inspection agency and related trade contractors.
- B. Coordinate work of Division 07 & 08 Sections and openings and penetrations and manufacturer's accessories with installation of metal panels.

1.5 DEFINITIONS

- A. Traditional Metal Building System: Building system using either continuous or simple span "Z" purlins for support of roof covering material.
- B. Long Bay System (LBS): Building system using simple span, cold-formed, open web purlins to support roof covering material.
- C. Gable Symmetrical: Continuous frame building with ridge in center of building, consisting of tapered or straight columns and tapered or straight rafters. Sidewall girts may be continuous (by-passing columns) or simple span (flush in column line). Rafters may or may not have interior columns.
- D. Gable Unsymmetrical: Continuous frame building with an off-center ridge, consisting of tapered or straight columns and tapered or straight rafters. Eave height and roof slope may differ on each side of ridge. Sidewall girts may be continuous (by-passing columns) or simple span (flush in column line). Rafters may or may not have interior columns.
- E. Single Slope: Continuous frame building which does not contain ridge, but consists of one continuous slope from side to side. Building consists of straight or tapered columns and tapered or straight rafters. Sidewall girts may be continuous (by-passing columns) or simple span (flush in column line). Rafters may or may not have interior columns.
- F. Lean-to (LT): Building extension, which does not contain ridge, but consists of one continuous slope from side to side, usually with same roof slope and girt design as building to which attached.
- G. Roof Slope: Pitch expressed as inches of rise for each 12 inches (305 mm) of horizontal run.
- H. Acrylic-Coated Galvalume: Aluminum-Zinc coated steel with a thin clear acrylic finish coating eliminating the need for roll-forming oil and reducing incidence of field marking by handling or foot traffic.
- I. Building Eave Height: Nominal dimension measured from finished floor to top flange of eave strut.
- J. Building Width: Measured from outside to outside of side wall secondary structural member.
- K. Building Length: Measured from outside to outside of end wall secondary structural member.
- L. Auxiliary Loads: Dynamic loads induced by cranes, conveyors, or material handling systems.
- M. Collateral Loads: Weight of any non-moving equipment or material, such as ceilings, electrical or mechanical equipment, sprinkler systems, plumbing, or ceilings.
- N. Dead Load: Actual weight of building system as supplied by manufacturer supported by given member.
- O. Floor Live Loads: Loads induced on floor system by building occupants and possessions including but not limited to furniture and equipment.
- P. Roof Live Loads: Loads produced by maintenance activities, rain, erection activities, and or movable or moving loads but not including wind, snow, seismic, crane, or dead loads.
- Q. Roof Snow Loads: Gravity load induced by weight of snow or ice on roof, assumed to act on horizontal projection of roof.

- R. Seismic Loads: Loads acting in any direction on structural system due to action of an earthquake.
- S. Wind Loads: Loads on structure induced by forces of wind blowing from any horizontal direction.

1.6 DESIGN REQUIREMENTS

- A. Governing Design Code: Structural design for the metal building system shall be performed by the manufacturer of the metal building system in accordance with the building code provided in the contract documents.
- B. Design Basis:
 - 1. Use standards, specifications, recommendations, findings, and interpretations of professionally recognized groups as basis for establishing design, drafting, fabrication, and quality criteria, practices, and tolerances, including the AISC Code of Standard Practice for Steel Buildings and Bridges.
 - 2. Design structures in accordance with MBMA Practices and Manual including fabrication and erection tolerances.
 - 3. Design structural mill sections and welded plate sections in accordance with AISC 360, ASD Method.
 - 4. Design the lateral force resisting systems and related components for seismic loads in accordance with AISC 341.
 - 5. Design cold-formed steel structural members and panels in accordance with AISI S-100.
 - 6. Design all bolted joints in accordance with RCSC Specification.
- C. Design Loads:
 - 1. In accordance with Contract Documents and manufacturer's standard design practices.
 - 2. Design loads include dead loads, roof live loads, wind loads, seismic loads, collateral loads, auxiliary loads, floor live loads and applied or specified loads.

1.7 SUBMITTALS

- A. Submittals for Review:
 - 1. Shop Drawings:
 - a. Complete erection drawings with identification and assembly of building components.
 - b. Show anchor bolt settings, transverse cross-sections, sidewall, endwall, and roof framing, flashing and sheeting, and accessory installation details.
 - c. Bear seal and signature of Registered Professional Engineer responsible for metal building system design in accordance with state law.
 - 2. Manufacturer installation manual showing:
 - a. Preparation instructions and recommendations.
 - b. Storage and handling requirements and recommendations.
 - c. Installation methods.
 - 3. Structural Design Calculations: 3 sets sealed and signed by a professional engineer licensed in accordance with applicable state law.
 - 4. Documentation [including test reports] supporting Thermal Transmission Coefficients (U-factors) and Solar Heat Gain Coefficients (SHGC; for non-opaque components only) of building envelope components specified in this section.

- B. Samples:
 - 1. Submit color chips showing manufacturer's full range of available colors and patterns for each finish product.
 - 2. After color selection submit samples representing actual product, color, and patterns.
- C. Quality Control Submittals:
 - 1. IAS AC472 Certificate for each facility involved in the design and fabrication of the Metal Building System.
 - 2. Certified Erector Certificate issued to the erector by the manufacturer.
 - 3. Material Test Reports (MTR) for all steel material used in the manufacture of primary and secondary framing members, panels and bolts specified in this section and when required by ASTM A 6/A 6M

1.8 QUALITY ASSURANCE

- A. Manufacturer and Fabricator Qualifications: Primary products furnished by single IAS AC472 accredited manufacturer/fabricator with minimum 5 years of experience.
- B. Erector Qualifications:
 - 1. Single installer with minimum 5 years of experience in installing products of same or similar type and scope.
 - 2. Installer must be certified by the metal building manufacturer.

1.9 DELIVERY, STORAGE AND HANDLING

- A. Store packaged products in original, unopened packaging until ready for installation.
- B. Store and dispose of solvent-based materials and materials used with solvent-based materials in accordance with requirements of the authority having jurisdiction.
- C. Protect steel products from weather as specified by manufacturer instructions.

1.10 PROJECT CONDITIONS

- A. Do not install systems when temperature, humidity, or ventilation is outside of limits recommended by manufacturer.

1.11 WARRANTIES

- A. Provide Single-Source Weathertightness Warranty by building manufacturer.
- B. Special Manufacturer's Warranty: On manufacturer's standard form, in which manufacturer agrees to repair or replace metal building system components that fail in materials and workmanship within one year from date of Substantial Completion.
- C. Special Weathertightness Warranty: On manufacturer's standard form, in which manufacturer agrees to repair or replace metal building system components that fail to remain weathertight, including leaks, without monetary limitation within 20 years from date of Substantial Completion.
- D. Special Panel Finish Warranty: On Manufacturer's standard form, in which Manufacturer agrees to repair or replace metal panels that evidence deterioration of factory-applied finish within the specified number years from date of Substantial Completion, including:

1. Acrylic Coated Galvalume (Galvalume® Plus): Product will not rupture, fail structurally, or perforate within period of 20 years due to normal atmospheric corrosion.
2. Fluoropolymer Two-Coat System (PVDF):
 - a. Color fading in excess of 10 Hunter units per ASTM D 2244 for 30 years.
 - b. Chalking in excess of No. 6 rating per ASTM D 4214 for 30 years.
 - c. Failure of adhesion, peeling, checking, or cracking for 40 years.
3. Metallic Fluoropolymer Two-Coat System (Metallic PVDF):
 - a. Chalking in excess of No. 6 rating per ASTM D 4214 for 25 years.
 - b. Failure of adhesion, peeling, checking, or cracking for 25 years.
4. Modified Silicone-Polyester Two-Coat System (SMP):
 - a. Color fading in excess of 7 Hunter units per ASTM D 2244, for vertical applications for 25 years.
 - b. Color fading in excess of 7 Hunter units per ASTM D 2244, for non-vertical applications for 25 years.
 - c. Chalking in excess of No. 7 rating per ASTM D 4214, for vertical applications for 25 years.
 - d. Chalking in excess of No. 6 rating per ASTM D 4214, for non-vertical applications for 25 years.
 - e. Failure of adhesion, peeling, checking, or cracking for 40 years.

PART 2 - PRODUCTS

2.1 MANUFACTURERS

- A. Basis of Design Manufacturer: Metallic Building Company www.metallic.com. Other acceptable manufacturers include:
 1. A&S Building Systems, subsidiary of NCI Building Systems, Inc. (www.a-s.com)
 2. All-American Systems, subsidiary of NCI Building Systems, Inc. (www.allamericansys.com)
 3. Ceco Building Systems, subsidiary of NCI Building Systems, Inc. (www.cecobuildings.com)
 4. Garco Building Systems, a subsidiary of NCI Building Systems, Inc. (www.garcobuildings.com)
 5. Mesco Building Solutions, subsidiary of NCI Buildings, Inc. (www.mescobuildingsolutions.com)
 6. Mid-West Steel Building Company, subsidiary of NCI Building Systems, Inc. (www.midweststeel.com)
 7. Robertson Buildings, subsidiary of NCI Building Systems, Inc. (www.robertsonbuildings.com)
 8. Star Building Systems, subsidiary of NCI Building Systems, Inc. (www.starbuildings.com)

B. Substitutions: Allowed

2.2 MATERIALS

- A. Primary Framing Steel:
 1. Hot-rolled shapes: ASTM A 36 or ASTM A 992, minimum yield of 36 ksi (248 MPa) or 50 ksi (345 MPa).
 2. Built-up sections:

- a. Webs:
 - 1) ASTM A 1011 or ASTM A1018, SS or HSLAS, Grade 55 (380) for webs 3/16 inch (4.76 mm) thick and thinner.
 - 2) ASTM A 572 Grade 50 (340) or ASTM A572 Grade 55 (380) or ASTM A 529 Grade 55 for webs thicker than 3/16 inch (4.76 mm).
 - b. Flanges: ASTM A 529 Grade 55 (380) or ASTM A 572 Grade 50 (340) or 55 (380).
 3. Round tube: ASTM A 500, Grade B or C with minimum yield strength of 42 ksi (290 MPa).
 4. Square and rectangular tube: ASTM A 500, Grade B or C, minimum yield strength of 42 ksi (290 MPa).
 5. Cold-formed C sections: ASTM A 1011, Grade 55 (380), or ASTM A 653, Grade 55 (380).
 6. X-bracing: ASTM A 529 or A 572 for rod bracing 36 ksi (248 MPa) or 50 ksi (345 MPa), ASTM A 36 for angle bracing or ASTM A 475 for cable bracing.
- B. Secondary Framing Steel:
1. Purlins, girts, and eave struts: ASTM A 1011 Grade 55 (380), or ASTM A 653, Grade 55 (380).
 2. Thickness:
 - a. 16 gauge: 0.056 inch (1.421 mm) minimum uncoated thickness.
 - b. 14 gauge: 0.067 inch (1.689 mm) minimum uncoated thickness.
 - c. 13 gauge: 0.081 inch (2.051 mm) minimum uncoated thickness.
 - d. 12 gauge: 0.100 inch (2.534 mm) minimum uncoated thickness.
 3. Finish: G-90 Pre-galvanized Shop Coat. Shop coat only intended to provide temporary protection during transportation and erection.
- C. Panels:
1. Materials: ASTM A 792.
 2. Thickness and yield strength:
 - a. 26 gauge: 0.0172 inch (0.437 mm) minimum uncoated thickness, 80 ksi (550 MPa) yield strength.
 - b. 24 gauge: 0.0212 inch (0.538 mm) minimum uncoated thickness, 50 ksi (340 MPa) yield strength.
 - c. 22 gauge: 0.0272 inch (0.690 mm) minimum uncoated thickness, 50 ksi (380 MPa) yield strength.
 3. Finishes:
 - a. Galvalume: Aluminum-Zinc Alloy Coating, 55% Aluminum, 50% Zinc coated steel per ASTM A 792 AZ55.
 - b. Galvalume® Plus: Acrylic-Coated Aluminum-Zinc Alloy Coating, 55% Aluminum, 50% Zinc coated steel per ASTM A 792 AZ55 with acrylic finish with no added lubricant.
 - c. Exterior Paint:
 - 1) Fluoropolymer Two-Coat System (PVDF): 0.2 – 0.3 mil primer with 0.7 - 0.8 mil 70 percent PVDF fluoropolymer color coat. Basis of Design: Signature 300.

- d. Interior Paint: 0.5 mil total dry film thickness consisting of primer coat and wash coat of manufacturer's standard light-colored acrylic or polyester backer finish.
4. Fasteners:
- a. Through-fastened panels: Self-drilling with sealing washer.
 - b. Standing seam panels: Long life self-drilling with sealing washer.
 - c. Ridge: Long-life self-drilling with sealing washer.
 - d. Clips to purlin or bar joists: Long-life self-drilling with hex washer head and washer.
5. Clips:
- a. Low or high fixed clips: Use where moderate thermal expansion and contraction in roof panel is expected.
 - b. Low or high sliding clips: Provide 2 to 4 inches of travel for panel thermal expansion and contraction.
6. Sealants and closures:
- a. Side-laps: Factory applied, hot melt, foamable mastic.
 - b. End-laps, eave, ridge assembly, gable flashings: Field-applied non-skinning sealant as specified in Section 07 92 00.
 - c. Standing Seam Roof Closures:
 - 1) Outside closures: 24 gauge steel sheet.
 - 2) Inside closures: 18 gauge Galvalume or G-40 galvanized coated steel complying with ASTM A 653/A 653M.
 - d. Through-Fastened Roof Closures: Provide closed-cell polyethylene inside [and outside] foam closures.
 - 1) Bulk Density: 2 pounds per cubic foot.
 - 2) Service Temperature: -100 to 180 degrees Fahrenheit.
 - 3) Shore Hardness: 7 on AA scale or 51 on 00 scale when tested to ASTM D 2240.

2.3 PRIMARY FRAMING

- A. Frame Design: As indicated on Drawings
- B. Sidewall Column Profile: As indicated on Drawings.
- C. Frame Span: Modular or Clear Span as indicated on Drawings.
- D. Modular Frame Interior Column Profile: H Shape, Round Pipe, or Tube as indicated on Drawings and required by building manufacturer.
- E. Bracing: Standard X-Bracing or Portal Frames as allowed by accessories

2.4 SECONDARY FRAMING

- A. Roof Zee Purlins:
 - 1. Horizontal structural members which support roof coverings.
 - 2. Depth: As required by design.
 - 3. Thickness: As required by design, 16 gauge minimum.

4. Finish: Gray shop coat. Shop coat only intended to provide temporary protection during transportation and erection.
- B. Long Bay Purlins:
1. Horizontal structural members that support roof systems, with virtual square shaped top and bottom chords and web members.
 2. Open Web Purlins for Long Bay applications.
 3. Finish: Gray shop coat. Shop coat only intended to provide temporary protection during transportation and erection.
- C. Wall Zee Girts:
1. Horizontal structural members that support vertical panels.
 2. Depth: As required by design.
 3. Gauge: As required by design, 16 gauge (0.056 inch (1.424 mm) minimum uncoated thickness).
 4. Finish: Gray shop coat. Shop coat only intended to provide temporary protection during transportation and erection.
- D. Spandrel Beams: ASTM A 36/A 36M or ASTM A 992/A 992M wide flange shapes, minimum yield 50 ksi for support of wall systems provided by others, as required by design.

2.5 BOLTS

- A. Rigid Frame Connections: Provide High Strength Bolts, Nuts and Washers:
1. Bolts: ASTM F 3125 Grade A325 Heavy Hex Structural Type I.
 2. Washers: ASTM F 436 Type 1 Hardened Steel
 3. Nuts: ASTM A 563 Grade C Heavy Hex. Nuts shall be wax coated by emulsion such that the torque required to complete a Rotational Capacity (RC) test shall be reduced by 40% from the un-waxed state.
 4. Coating: Hot-Dipped Galvanized.
- B. Other Connections: Provide High Strength or Machine Bolts as required by manufacturer design:
1. High Strength Bolts and Nuts:
 - a. Bolts: ASTM F 3125 Grade A325 Heavy Hex Structural Type I.
 - b. Nuts: ASTM A 563 Grade C Heavy Hex.
 - c. Coating: ASTM F 1941 Electrodeposited Yellow Zinc.
 2. Machine Bolts:
 - a. Bolts: ASTM A 307 Grade Carbon Steel.
 - b. Nuts: ASTM A 563 Grade A Hex Nut.
 - c. Coating: ASTM F 1941 Electrodeposited Clear Zinc.

2.6 ROOF SYSTEMS

- A. Assembly Performance Requirements: Provide roof products and assemblies meeting the following requirements:
1. Class 90 rated and listed in accordance with UL-580 for Wind Uplift.
 2. Class A rated and listed in accordance with UL-790 for External Fire.
 3. Class 4 rated and listed in accordance with UL-2218 for Impact Resistance.
- B. Through-Fastened Panels:

1. Type: Single skin ribbed panels with exposed fasteners.
2. Strength: Determine and certify allowable panel strengths in accordance with AISI S100.
3. Panel profile(s): PBR; 1-1/4 inch (32 mm) ribs at 12 inch (305 mm) centers, 1/2:12 minimum roof slope.
 - a. Thickness: 24 gauge
 - b. Finish: PVDF
 - c. Color: Selected from manufacturer standard colors & as shown on drawings.
 - d. Air Infiltration: Maximum air infiltration of 0.04 cubic feet per minute per square foot of specimen area when tested to ASTM E 1680 at a pressure differential of +/- 1.57 psf (75 Pa).
 - e. Water Infiltration: No uncontrollable water leakage when tested to ASTM E 1646 at a 20 psf (955 Pa) pressure differential when sprayed with 5 gallons of water per hour per square foot (203 liters per square meter) of specimen area.
4. Panel fasteners: Long-life finish
5. Sidelap mastic: 1 inch x 3/32 inch (25 mm x 2.4 mm).

C. Standing Seam Panels:

1. Type: Single skin panels with concealed clips.
2. Panel Strength: Determine and certify panel strength as follows:
 - a. Positive Loading (Toward Panel Supports): Determine in accordance with AISI S100.
 - b. Negative Loading (Away from Panel Supports): Determine in accordance with ASTM E 1592.
3. Panel profile:
 - a. Panel Type: Trapezoidal machine seamed, 1/4:12 minimum roof slope.
 - b. Panel width: 24 inches wide x 3 inches high (610 mm wide x 76 mm high) or per building manufacturer.
 - c. Thickness: 24 gauge.
 - d. Finish: PVDF.
 - e. Color: Selected from manufacturer standard colors & as shown on drawings.
 - f. Air Infiltration: Maximum air infiltration of 0.04 cubic feet per minute per square foot of specimen area when tested to ASTM E 1680 at a pressure differential of +/- 1.57 psf (75 Pa).
 - g. Water Infiltration: No uncontrollable water leakage when tested to ASTM E 1646 at a 20 psf (955 Pa) pressure differential when sprayed with 5 gallons of water per hour per square foot (203 liters per square meter) of specimen area.
 - h. Color: Selected from manufacturer standard colors & as shown on drawings.
4. Panel clips: As required by design and insulation requirements.
5. Thermal spacers: As Required for insulation system and panel clip.

D. Accessories

1. Pipe flashing: as required
2. Roof curbs: as required
3. Roof Vents:
 - a. Source: By metal building system manufacturer
 - b. Type: round gravity [24 inch (610 mm) round gravity]
 - c. Finish: Prefinished white.
4. Eave trim condition: Standard gutters and downspouts

2.7 WALL, LINER, SOFFIT, AND FASCIA PANEL SYSTEMS

- A. Assembly Performance Requirements: Provide assemblies that function as exterior walls that meet the following requirements:
1. Air Infiltration: Maximum air infiltration of 0.04 cubic feet per minute per square foot of specimen area when tested to ASTM E 283 at a pressure differential of +/- 1.57 psf (75 Pa).
 2. Water Infiltration: No uncontrollable water leakage when tested to ASTM E 331 at a 6.24 psf pressure differential when sprayed with 5 gallons of water per hour per square foot of specimen area.
- B. Through-Fastened Panels:
1. Panel type: Single skin ribbed panels with exposed fasteners.
 2. Panel Strength: Determine in accordance with AISI S100.
 3. Panel profiles:
 - a. PBR: 12 inch x 1 inch (305 mm x 25 mm) Rib. 1-1/4 inch (32 mm) ribs x 12 inch (305 mm) centers.
 - b. Reverse Rolled PBR: 1-1/4 inch (32 mm) inverted ribs x 12 inch centers.
 - c. AVP: 1-1/8 inch (28.5 mm) inverted ribs x 12 inch (305 mm) centers.
 - d. PBU: 3/4 inch (19 mm) ribs x 6 inch (152 mm) centers.
 - e. Reverse Rolled PBU: 3/4 inch (19 mm) ribs x 6 inch (152 mm) centers.
 - f. 7.2: 1-1/2 inch (39 mm) ribs x 7.2 inch (183 mm) centers.
 - g. PBC: 7/8 inch (22 mm) corrugated x 2.67 inch (68 mm) centers.
 - h. PBD: 5/8 inch (16 mm) ribs x 2.67 inch (68 mm) centers.
 4. Thickness: 24 gauge.
 5. Finish: PVDF.
 6. Color: Selected from manufacturer standard colors & as shown on drawings.
 7. Panel fasteners: Long-life finish.
 8. Fire Resistance:
 - a. Third-party listed assembly tested to and meeting the requirements of NFPA 285.
 - b. FM 4880 Class 1 Approval with no height restrictions.
 - c. Flame Spread and Smoke Developed Index: The Flame Spread Index shall not exceed 25 and the Smoke Developed Index shall not exceed 450 when tested to ASTM E84.
 9. Panel Strength: Determine and certify panel strength as follows:
 - a. Positive Loading (Toward Panel Supports): Determine in accordance with ASTM E 72.
 - b. Negative Loading (Away from Panel Supports): Determine in accordance with ASTM E 1592.
 10. U-Factor Determination: ASTM C 1363 conducted in accordance with ASHRAE 90.1 Section A9.3.2 or by Finite Element Modeling per ASHRAE 90.1 Section A9.4 and using core insulation thermal conductivity (k-factor) determined using ASTM C 518 conducted at 75 degree F mean temperature in the calculation.
- C. Accessories:
1. Base condition:
 - a. Formed base: Pre-finished bronze, self-flashing, for through-fastened panels.

- b. Base member: Angle with flashing.
 - c. Base member flashing: As indicated on Drawings.
2. Framed openings:
- a. Finish: Match girt finish.
 - b. Framed opening trim: [Standard jamb, head, sill trim package] [Standard trim plus full cover trim on exposed jambs and headers].
3. Trim profiles: Manufacturer's standard profiles.
- a. Thermal Transmission: Provide U-Factor determined by ASTM C 1363 conducted in accordance with ASHRAE 90.1 Section A9.3.2 or by Finite Element Modeling per ASHRAE 90.1 Section A9.4
 - b. Solar Heat Gain Coefficient: Provide SHGC determined by NFRC 200.

2.8 FABRICATION

A. General:

- 1. Shop-fabricate framing members for field bolted assembly.
- 2. Surfaces of bolted connections: Smooth and free from burrs and distortions.
- 3. Shop connections to conform to manufacturer's standard design practices.
- 4. Mark framing members with identifying mark.
- 5. Welding to conform to AWS D1.1 and AWS D1.3 as applicable.

B. Primary Framing:

- 1. Plates, stiffeners, and related members: Factory welded base plates, splice plates, cap plates, and stiffeners into place on structural members.
- 2. Bolt holes and related machining: Shop fabricate base plates, splices and flanges to include bolt connection holes. Shop-fabricate webs to include bracing holes.
- 3. Secondary structural connections (purlins and girts): Ordinary (not pretensioned) bolted connections with welded clips.
- 4. Welding inspection: Per IAS AC472 Part A.

C. Long Bay Purlins:

- 1. Fabricate purlins from cold-formed open web long bay system assemblies with stiffened chords.
- 2. Install connection bolts through purlin seats.
- 3. Pre-punch assemblies to allow for attachment of frame flange brace angles, compression strut extensions, and diagonal X-bridging at centerline.
- 4. Furnish bridging as light-gauge cold-formed angles secured using self-drilling fasteners.
- 5. Manufacture sections in IAS AC472 Part A and B Accredited facility.
- 6. Top and bottom chords: Nominal 4 inch (102 mm) width formed so that top surface is continuous and flat to facilitate easy assembly of roof system.
- 7. Fabricate all elements of minimum 16 gauge steel.
- 8. Subject finished assemblies to periodic testing to loads equal to 110 percent of design loads.

D. Zee Purlins:

- 1. Fabricate purlins from cold-formed Z-shaped sections with stiffened flanges.
- 2. Size flange stiffeners to comply with requirements of AISI S100.
- 3. Purlin flanges unequal in width for easier nesting during erection.
- 4. Purlins pre-punched at factory to provide for field bolting to rigid frame clips.

- E. Eave Struts:
1. Fabricate eave struts from cold-formed unsymmetrical C-shaped sections with stiffened flanges.
 2. Size flange stiffeners to comply with requirements of AISI S100.
 3. No welded splices permitted.
 4. Eave Struts pre-punched at factory to provide for field bolting to rigid frame clips.
- F. Girts: Simple or continuous span as required by design. Connection bolts will install through webs not flanges.
- G. Bracing:
1. Diagonal Bracing:
 - a. Diagonal bracing in roof and sidewalls may be used to resist longitudinal loads in structure when panel diaphragm cannot be used.
 - b. Furnish to length and equipped with hillside washers and nuts at each end.
 - c. Bracing may consist of rods threaded at each end or galvanized cable with suitable threaded end anchors.
 - d. If load requirements dictate, bracing may be of structural angle or pipe, bolted in place.
 2. Special Bracing:
 - a. When diagonal bracing is not permitted in sidewall use rigid frame type portal or fixed base column.
 - b. Shear walls may be used where adequate to resist applied wind or seismic forces.
 3. Flange Braces: Brace compression flange of primary framing laterally with angles connecting to purlin or girt webs so that flange compressive stress is within allowable limits for any combination of loading.
 4. Bridging:
 - a. Laterally brace top chord of long bay purlins with horizontal bridging if roof system being used will not supply adequate lateral support to top chord.
 5. Horizontally bridge bottom chord for lateral bracing. One row of bolted diagonal bridging required for long span purlins 40 feet (12 192 mm) long and longer.
- H. Standing Seam Panels:
1. Provide factory fabricated and finished metal panels and accessories meeting performance requirements, indicated profiles and structural requirements.
 2. Fabricate metal joints configured to accept applied sealant providing weathertight seal and preventing metal to metal contact and minimizing noise resulting from thermal movement.
 3. Fabricate panels in continuous lengths for full length of detailed runs, except where otherwise indicated on drawings.
 4. Sheet Metal Flashing and Trim: Fabricate or install flashing and trim to comply with manufacturer's written instructions and construction drawings.
 5. Configure panels with interlocking edges with factory applied hot-melt mastic inside female seam. Female side snaps over male side and when seamed creates continuous lock, forming 360 degree Pittsburgh seam.
 6. Notch panels at factory at both ends so that field installation can commence or terminate from either end of building.
 7. Maximum panel length: 45 feet (13 716 mm) unless otherwise indicated.

- I. End Laps:
 - 1. Fabricate with 16 gauge backup plates and eight end lap joint fasteners installed in six pre-punched holes in flat and in dimples in trapezoidal legs.
 - 2. Apply mastic between panels and secure with self-drilling fasteners through panels and backup plate.
 - 3. Through roof fasteners may be used only at end laps and eaves.

PART 3 - EXECUTION

3.1 PREPARATION

- A. Clean surfaces prior to installation.
- B. Prepare surfaces using methods recommended by manufacturer for best result for substrate.

3.2 INSTALLATION

- A. Install system in accordance with manufacturer's instructions and approved Shop Drawings.
- B. Fit members square against abutting components.
- C. Position members plumb, square, and level.
- D. Temporarily brace members until permanently fastened.
- E. Do not splice load bearing members.
- F. Align and adjust various members forming parts of a complete frame or structure after assembly but before fastening.
- G. Welding to conform to AWS D1.1.
- H. Fasten panels to supports.
- I. Install trim to maintain visual continuity of system.
- J. Install joint sealant and gaskets to prevent water penetration.
- K. Flash penetrations through roofing with metal trim to match panels

3.3 PROTECTION

- A. Protect installed products until completion of project.

3.4 ADJUSTMENT

- A. Touch up, repair, or replace damaged products before Substantial Completion.

END OF SECTION

TECHNICAL SPECIFICATIONS FOR GLENDALE FIRE STATION

SECTION 15010-BASIC MECHANICAL REQUIREMENTS

PART 1 - GENERAL

RELATED DOCUMENTS:

Drawings and general provisions of Contract, including General and Special Conditions, apply to work of this section.

SUMMARY:

This section specifies the basic requirements for mechanical installations. It expands and supplements the requirements specified in sections under "General Requirements".

ACCESSIBILITY:

Install equipment and materials to provide required access for servicing and maintenance. Coordinate the final location of concealed equipment and devices requiring access with final location of required access panels and doors. Allow ample space for removal of all parts that require replacement or servicing.

Extend all grease fittings to an accessible location.

MECHANICAL INSTALLATIONS:

- Coordinate mechanical equipment and materials installation with other building components.
- Verify all dimensions by field measurements.
- Coordinate the installation of required supporting devices and sleeves to be set in poured in place concrete and other structural components, as they are constructed.
- Sequence, coordinate, and integrate installations of mechanical materials and equipment for efficient flow of the Work.
- Install mechanical equipment to facilitate maintenance and repair or replacement of equipment components. As much as practical, connect equipment for ease of disconnecting, with minimum of interference with other installations.
- Coordinate connection of mechanical systems with exterior underground and overhead utilities and services. Comply with requirements of governing regulations, franchised service companies, and controlling agencies. Provide required connection for each service.

MECHANICAL SUBMITTALS:

Submittal of shop drawings, product data, and samples will be accepted only when submitted by the Contractor. Data submitted from subcontractors and material suppliers directly to the

Engineer will not be processed. Submit five (5) complete sets of all shop drawings and product data.

NAMEPLATE DATA:

Provide permanent operational data nameplate on each item of power operated mechanical equipment, indicating manufacturer, product name, model number, serial number, capacity, operating and power characteristics labels of tested compliances, and similar essential data. Locate nameplates in an accessible location.

PART 2 - PRODUCTS

DELIVERY, STORAGE, AND HANDLING:

Deliver products to project properly identified with names, model numbers, types, grades, compliance labels, and similar information needed for distinct identifications; adequately packaged and protected to prevent damage during shipment, storage, and handling.

Store equipment and materials at the site, unless off-site storage is authorized in writing. Protect stored equipment and materials from damage.

PART 3 - EXECUTION

RECORD DOCUMENTS:

Refer to the Section 01705 - "Project Closeout" for requirements. The following paragraphs supplement the requirements in sections under "General Requirements".

Mark drawings to indicate revisions to piping, size and location both exterior and interior; actual equipment locations, dimensioned for column lines; actual inverts and locations of underground piping; concealed equipment, dimensioned to column lines; mains and branches of piping systems, with valves and control devices located and numbered, concealed unions located, and with items requiring maintenance located (i.e., traps, strainers, expansion compensators, tanks, etc.); Change Orders; concealed control system devices.

Mark Specifications to indicate approved substitutions, Change Orders, actual equipment and materials used.

OPERATION AND MAINTENANCE DATA:

Refer to Section 01705 - "Project Closeout" for procedures and requirements for preparation and submittal of maintenance manuals.

Include the following information:

- Description of function, normal operating characteristics and limitations, performance curves, engineering data and tests, and complete nomenclature and commercial numbers of all replaceable parts.
- Manufacturer's printed operating procedures to include start-up, break-in, routine and normal operating instructions; regulation, control, stopping, shut-down, and emergency instructions; and summer and winter operating instructions.
- Maintenance procedures for routine preventative maintenance and troubleshooting; disassembly, repair, and reassembly; aligning and adjusting instructions.
- Servicing instructions and lubrication charts and schedules.

WARRANTIES:

Compile and assemble the warranties into a separated set of vinyl covered, three ring binders, tabulated and indexed for easy reference.

Provide complete warranty information for each item to include product or equipment to include date of beginning of warranty or bond; duration of warranty or bond; and names, addresses, and telephone numbers and procedures for filing a claim and obtaining warranty services.

CLEANING:

Refer to the Section 01705 - "Project Closeout" for general requirements for final cleaning.

TECHNICAL SPECIFICATIONS FOR GLENDALE FIRE STATION

SECTION 15051- MECHANICAL RELATED WORK

PART 1 - GENERAL

RELATED DOCUMENTS:

Drawings and general provisions of Contract, including General and Special Conditions, apply to work of this Section.

DESCRIPTION OF WORK:

Extent of mechanical related work and work required by this section is indicated on drawings and/or specified in other sections.

Contractor shall furnish all labor, material and equipment, and shall perform all operations required to satisfactorily and properly install, adjust, test and place into operation all equipment and system shown on the construction drawings. Submittal data and as-built drawings shall also be required for each piece of equipment or installation.

EQUIPMENT INSTALLATION:

All equipment and systems shown on the drawings and/or specified herein shall be installed in a workmanlike manner and in strict accordance with the manufacturer's recommendations. All required piping, electrical connections and other necessary items shall be furnished and connected in order to provide a complete operating facility.

EQUIPMENT TESTING AND ADJUSTING:

After installation, the Contractor shall demonstrate that all equipment is operating in a satisfactory manner. All equipment shall be lubricated according to recommendations of the vendors and all adjustments shall be made to suit anticipated operating conditions. Each piece of equipment shall be tested to show that it operated quietly, without vibration, overheating, or signs of distress, at full specified capacity. Adjustments shall be made as necessary. All defective parts of machinery, equipment or materials, shall be replaced. Vendor's certificates that the installation of equipment is in accordance with the manufacturer's recommendations shall be secured by the Contractor and submitted to the Engineer.

The Contractor shall furnish to the Engineer five copies of all necessary manuals and instructions describing the proper operation and maintenance of each type of equipment furnished.

INSTALLATION SUPERVISION:

Installation and initial start-up and operation of all equipment shall be performed under the supervision of a factory-trained technical representative of the manufacturer. The services of the manufacturer's representative shall include instruction of the Owner's operator in the operation, maintenance and adjustment of the equipment. The Contractor shall give the Engineer and Owner's operator 48 hours notice before start-up. Start-up shall not proceed without the presence of the Engineer.

EQUIPMENT REQUIREMENTS:

The following requirements shall apply to equipment furnished in the Contracts:

- Each piece of mechanical equipment and motors shall be provided with a substantial nameplate of non-corrodible metal, securely fastened in place, clearly and permanently inscribed with the manufacturer's name, model or type designation, serial number, rated capacity, electrical or other power characteristics, and other appropriate nameplate data.
- All equipment shall be delivered fully lubricated with oil and/or grease insofar as possible. If any point cannot be so serviced, it shall be clearly marked to the effect that it is not lubricated and requires servicing prior to operation. An adequate supply of the proper lubricant, with instructions for its application, shall be supplied with the equipment for each point not lubricated prior to shipment.
- The Contractor shall also provide the Owner with a sufficient amount of proper lubricants for one complete change of lubricant for all equipment furnished.
- All factory painted equipment shall be provided with two (2) pints of touch up paint to match original finish along with instructions for application.

PART 2 - PRODUCTS (Not Applicable)

PART 3 - EXECUTION (Not Applicable)

TECHNICAL SPECIFICATIONS FOR GLENDALE FIRE STATION

SECTION 15060-PIPE AND PIPE FITTINGS

PART 1 - GENERAL

RELATED DOCUMENTS:

Drawings and general provisions of Contract, including General and Special Conditions, apply to work of this section.

DESCRIPTION OF WORK:

Extent of pipes and pipe fittings required by this section is indicated on drawings and/or specified in other sections.

Types of pipes and pipe fittings specified in this section include the following:

- Ductile - Iron Pressure Pipes (Pressure Pipe)
- Plastic Pipes (Pressure Pipes)
- Miscellaneous Piping Materials/Products

Pipes and pipe fittings furnished as part of factory-fabricated equipment are specified as part of equipment assembly in other sections.

QUALITY ASSURANCE:

Manufacturer's Qualifications: Firms regularly engaged in manufacture of pipes and pipe fittings of types and sizes required, whose products have been in satisfactory use in similar service for not less than 5 years.

Codes and Standards:

- Welding: Qualify welding procedures, welders and operators in accordance with ASME B31.1, or ASME B31.9, as applicable, for shop and project site welding of piping work.
- Brazing: Certify brazing procedures, brazers, and operators in accordance with ASME Boiler and Pressure Vessel Code, Section IX, for shop and job-site brazing of piping work.
- NSF Labels: Where plastic piping is indicated to transport potable water, provide pipes and pipe fittings bearing approval label by National Sanitation Foundation (NSF).

PART 2 – PRODUCTS

GENERAL:

Piping Materials: Provide pipe and tube of type, joint type, grade, size and weight (wall thickness or class) indicated for each service. Where type, grade or class is not indicated, provide proper selection as determined by Installer for installation requirements, and comply with governing regulations and industry standards.

Pipe/Tube Fittings: Provide factory-fabricated fittings of type, materials, grade, class and pressure rating indicated for each service and pipe size. Provide sizes and types matching pipe, tube, valve or equipment, connection in each case. Where not otherwise indicated, comply with governing regulations and industry standards for selections, and with pipe manufacturer's recommendations where applicable.

DUCTILE-IRON PRESSURE PIPES AND PIPE FITTINGS:

Ductile-Iron Pipe: ANSI A21.51; AWWA C151.

Ductile-Iron Fittings: AWWA C110.

Rubber-Gasket Joints: AWWA C111.

Where ductile iron pipe and fittings are to be below ground or installed in a casing pipe, the coating shall be a minimum 1.0 mil thick in accordance with ANSI/AWWA A21.51. Where ductile iron pipe and fittings are to be installed above ground, pipe, fittings and valves shall be thoroughly cleaned and given one field coat (minimum 1.5 mils dry thickness) of rust inhibitor primer. The intermediate and field coats of Alkyd shall also be applied by the Contractor (minimum 1.5 mil dry thickness each coat). Primer and field coats shall be compatible and shall be applied in accordance with the manufacturer's recommendations. Final field coat shall be blue.

All ductile iron pipe and fittings shall have an interior protective lining of cement-mortar with a seal coat of asphaltic material in accordance with ANSI/AWWA A21.4/C104.

PLASTIC PIPES AND PIPE FITTINGS:

Use Polybutylene Pipe (PB) ASTM C 902, SDR 11, or Polyethylene Pipe (PE) ASTM D 1248, D 3350, Type III, Grade P 34 for water services.

Use Polyvinyl Chloride Pipe (PVC) AWWA C 900 (latest revision) for potable water mains. Use either SDR 18 or SDR 25 as shown on the plans.

Pressure Pipe Fitting 4" and Larger: Use mechanical joint, ductile iron Class 350, compact fittings manufactured in accordance with ANSI/AWWA C153/A21.53-84, as manufactured by Union Foundry, or equal.

PE Fittings:

- Butt Heat Fusion: ASTM D 3261.

- Insert Fusion: ASTM D 3197.
- Socket Type: ASTM D 2683.
- Insert: ASTM D 2609.

MISCELLANEOUS PIPING MATERIALS/PRODUCTS:

Welding Materials: Except as otherwise indicated, provide welding materials as determined by Installer to comply with installation requirements.

Comply with Section II, Part C, ASME Boiler and Pressure Vessel Code for welding materials.

Soldering Materials: Except as otherwise indicated, provide soldering materials as determined by Installer to comply with Installation requirements.

Gaskets for Flanged Joints: ANSI B16-21, full-faced for cast-iron flanges, raised-face for steel flanges, unless otherwise indicated.

PART 3 - EXECUTION

INSTALLATION:

General Instructions:

- All excavation and backfilling for underground piping shall be done in accordance with the applicable sections of these specifications. All pipe, fittings, and valves shall be carefully handled at all times to prevent damage to the pipe or other installations on the job site. Install ductile-iron water mains and appurtenances in accordance with AWWA C 600. Install PVC pressure pipe in accordance with AWWA C605.
- All joints shall be wiped free of all dirt, sand and foreign material and the pipe shall be carefully examined for defects before installation.
- At times when pipe installation is not in progress, the open ends of the pipe shall be closed by approved means and shall remain closed until construction on that particular section is resumed, eliminating the possibility of any flow obstructions getting into the pipe.

Install pipes and pipe fittings in accordance with recognized industry practices which will achieve permanently leakproof piping systems, capable of performing each indicated service without piping failure. Install each run with minimum joints and couplings, but with adequate and accessible unions for disassembly and maintenance/replacement of valves and equipment. Reduce sizes (where indicated) by use of reducing fittings. Align piping accurately at connections, within 1/16" misalignment tolerance.

INSTALLATION OF COPPER LOCATION WIRE AND DETECTABLE WARNING TAPE:

All non-metallic water lines and sewer force mains (including service lines) shall be installed with underground 8 gauge insulated traceable copper wire, and underground locator marking tape. The insulated copper wire shall be buried along with the water main and shall be a continuous strand attached to all fire hydrants and valves. The detectable locator tape is not required over service lines. Locator tape shall be installed a minimum of 12 inches below ground surface or pavement directly over the pipeline. Detectable locator tape shall run continuously and where splicing is required, shall be over-lapped a minimum of 12 inches. The locator tape shall be of an inert polyethylene material having a minimum thickness of 0.1 mm and shall be color-coded "Safety Green" as adopted by the American Public Works Association and the Florida Utilities Coordination Committee. Following placement of the detectable locator tape and traceable wire, the trench shall be backfilled with due caution to prevent displacement or damage to either. After insulation and backfill have been completed the contractor shall perform a detection test in the Engineer's presence using a commercially available pipe detector furnished by the Contractor. Any undetectable tape or wire shall be replaced by the Contractor to the satisfaction of the Engineer at no additional expense to the Owner.

PVC FITTINGS:

PVC fittings will not be used on pressure pipe larger than 3" in diameter.

PIPING SYSTEM JOINTS:

General: Provide joints of type indicated in each piping system.

Weld pipe joints of steel water pipe in accordance with AWWA C 206.

Flanged Joints: Match flanges within piping system, and at connections with valves and equipment. Clean flange faces and install gaskets. Tighten bolts to provide uniform compression of gaskets.

Plastic Pipe/Tube Joints: Comply with manufacturer's instructions and recommendations, and with applicable industry standards.

Heat Joining of Thermoplastic Pipe: ASTM D 2657.

ANCHORAGE OF BENDS, TEES, AND PLUGS:

Limiting Pipe Diameter and Degree of Bend: Reaction of thrust backing shall be applied on all pipe lines at all tees, plugs, caps and at bends deflecting 22-1/2 degrees or more, or movement shall be prevented by attaching suitable metal rods or straps as directed.

Materials for Reaction Backing: Reaction or thrust backing shall be of concrete that conforms with sections of these specifications, but may have a 28 day compressive strength of not less than 2000 psi. Reaction backing will be placed in accordance with the schedule on the construction plans.

Backing shall be placed between solid ground and the fitting to be anchored. The backing shall, unless otherwise directed, be so placed that the pipe and fitting joints will be accessible for repairs. No extra payment will be made for this material but shall be included in the unit price bid.

In some cases, the Engineer may direct the Contractor to provide backing using cable and "deadman" anchors where the soil conditions will not support the normal concrete type as described above.

CLEANING, FLUSHING, INSPECTING:

General: Clean exterior surfaces of installed piping systems of superfluous materials, and prepare for application of specified coatings (if any). Flush out piping systems with clean water before proceeding with required tests. Inspect each run of each system for completion of joints, supports and accessory items.

Inspect pressure piping in accordance with procedures of ASME B 31.

Disinfect water mains and water service piping in accordance with AWWA C 601.

WATER MAIN PIPING TEST:

General: Provide temporary equipment for testing, including pump and gauges. Test piping system before insulation is installed wherever feasible, and remove control devices before testing. Test each natural section of each piping system independently but do not use piping system valves to isolate sections where test pressure exceeds valve pressure rating. Fill each section with water and pressurize for indicated pressure and time.

Required test period is 2 hours.

Test pipe at 150 psi, except where fittings are lower Class or pressure rating.

Permissible leakage:

| | <u>gal's/1000'/24 hrs</u> | <u>gal's/1000'/1 hr</u> |
|--------|---------------------------|-------------------------|
| 1-1/4" | 2.4 gal. | 0.10 gal. |
| 1-1/2" | 2.9 gal. | 0.12 gal. |
| 2" | 4.1 gal. | 0.17 gal. |
| 2-1/2" | 5.0 gal. | 0.21 gal. |
| 3" | 6.0 gal. | 0.25 gal. |
| 4" | 7.9 gal. | 0.33 gal. |
| 6" | 12.0 gal. | 0.50 gal. |
| 8" | 15.8 gal. | 0.66 gal. |
| 10" | 19.9 gal. | 0.83 gal. |
| 12" | 23.8 gal. | 0.99 gal. |

| | | |
|-----|-----------|-----------|
| 14" | 27.8 gal. | 1.16 gal. |
| 16" | 31.7 gal. | 1.32 gal. |
| 18" | 35.8 gal. | 1.49 gal. |

Should any test of combined sections of pipe disclose leakage greater than the specified limit, the Contractor shall, at his own expense, locate and repair the defective joints until the leakage is within the specified allowance.

Water for testing shall be provided by the Contractor.

Pipe may be subjected to hydrostatic pressure, inspected and tested for leakage at any convenient time after partial completion of backfill. The Contractor may test the system with joints exposed or backfilling complete at his option. The Engineer shall be notified at least 48 hours before beginning testing.

Drain test water from piping systems after testing and repair work has been completed.

TECHNICAL SPECIFICATIONS FOR GLENDALE FIRE STATION

SECTION 15065-GRAVITY SANITARY SEWAGE SYSTEMS

PART 1 - GENERAL

1.1 RELATED DOCUMENTS

Drawings and general provisions of Contract, including General and Special Conditions, apply to work of this section.

1.2 DESCRIPTION OF WORK

Extent of sanitary sewage systems work is indicated on drawings.

Sewer collection system work includes, but is not limited to, the following: sanitary sewer conduits and watertight manholes.

Excavation and backfilling for sewer collection system is specified in the applicable sections herein.

1.3 QUALITY ASSURANCE

Manufacturer's Qualifications: Firms regularly engaged in manufacture of sanitary sewage system's products of types, materials, and sizes required, whose products have been in satisfactory use in similar service for not less than three years.

Installer's Qualifications: Firm with at least three years of successful installation experience on projects with sanitary sewage work similar to that required for project.

Codes and Standards:

Plumbing Code Compliance: Comply with applicable portions of National Standard Plumbing Code pertaining to selection and installation of sanitary sewage system materials and products.

1.4 SUBMITTALS

Product Data: Submit manufacturer's technical product data and installation instructions for sewage system materials and products.

Record Drawings: At project closeout, submit record drawings of installed sanitary sewage piping and products. Drawings must be in AutoCAD drawing format.

Maintenance Data: Submit maintenance data and parts lists for sanitary sewage system materials and products. Include this data, product data, shop drawings, and record drawings in maintenance manual.

PART 2 - PRODUCTS

2.1 PIPES AND PIPE FITTINGS

General: Furnish elbows, tees, reducing tees, wyes, couplings, increasers, crosses, transitions and end caps of same type and class of material as conduit, or of material having equal or superior physical and chemical properties as acceptable to the Engineer.

Polyvinyl Chloride (PVC) Sewer Pipe 4" or Larger: Use ASTM D 3034, Type PSM, SDR 35; H & W Industries or equal.

PVC Fittings 6" and Larger: ASTM D 3034-89, or elastomeric joints complying with ASTM D 3212 using elastomeric seals complying with ASTM F 477-76; J-M Manufacturing or equal.

2.2 CONCRETE MANHOLES

Precast Concrete Manholes and Bases: Sikes Concrete Pipe Co., Hydroconduit, or equal meeting ASTM C 478, sized as indicated. Concrete manholes and bases shall be manufactured in accordance with the latest edition of ASTM SPECIFICATIONS C-478 and C-76 with 4000 PSI CONCRETE, TYPE II CEMENT. Exterior and interior coating shall consist of two (2) coats of bituminous waterproofing material: Koppers 3m or equal. Do not coat joints or pipe opening surfaces.

Manholes shall be constructed to be completely watertight. The contractor shall test the manhole by one of the following methods: (1) Infiltration test: If the manhole is located below the groundwater table, the inverts shall be plugged and the infiltration into the manhole shall be measured after a 12-hour period. If any visible infiltration has occurred into the manhole, visible by wet walls or any accumulation on the bench, the infiltration shall be considered excessive. (2) If the manhole is above the current groundwater table an exfiltration test will be conducted. All incoming sewer lines shall be plugged and the manhole filled with water to a level above the highest section joint. If the water level drop exceeds 1/8" per vertical foot of manhole depth in 30 minutes, the manhole shall have failed the test.

Fittings: In every instance where a pipe enters or leaves a manhole, a watertight fitting shall be provided.

2.3 WATERTIGHT MANHOLE ACCESSORIES

Watertight Manhole Frames and Covers: U. S. Foundary No. 170, Type E, "O" Ring gasketed heavy traffic or equal.

Furnish covers with cast-in legend ("Sanitary Sewer") on roadway face. Manufacturer shall provide a drawing showing this wording for approval prior to casting.

Manhole Steps: Polypropylene plastic outer shell covering a No. 3 deformed steel bar as manufactured by M. A. Industries, Inc., East Point, Georgia US Foundaries, Inc., Miami, Florida, or approved equal.

PART 3 - EXECUTION

3.1 INSTALLATION OF PIPE AND FITTINGS

General: Install piping in accordance with governing authorities having jurisdiction, except where more stringent requirements are indicated.

Inspect piping before installation to detect apparent defects. Mark defective materials with white paint and promptly remove from site.

Lay piping beginning at low point of system, true to grades and alignment indicated, with unbroken continuity of invert.

Place bell ends or groove ends of piping facing upstream.

Install gaskets in accordance with manufacturer's recommendations for use of lubricants, cements, and other special installation requirements.

Plastic Pipe: Install in accordance with manufacturer's installation recommendations, and in accordance with ASTM D 2321. **The Contractor shall provide for groundwater removal and support of trench walls per ASTM D2321, Section 6. The Contractor is responsible for trench safety.**

Cleaning Piping: Clear interior of piping of dirt and other superfluous material as work progresses. Maintain swab or drag in line and pull past each joint as it is completed. In large, accessible piping, brushes and brooms may be used for cleaning. Place plugs in ends of uncompleted conduit at end of day or whenever work stops. Flush lines between manholes if required to remove collected debris.

Interior Inspection: Inspect piping to determine whether line displacement or other damage has occurred.

Make inspections after lines between manholes, or manhole locations, have been installed and approximately 2 feet of backfill is in place, and again at completion of project.

If inspection indicates poor alignment, debris, displaced pipe, infiltration, or other defects, correct such defects, and reinspect.

3.2 SANITARY MANHOLES

General: Place precast concrete sections as indicated. Where manholes occur in pavements, set tops of frames and covers flush with finish surface. Elsewhere, set tops 6 inches above finish surface, unless otherwise indicated.

Install in accordance with ASTM C 891.

Provide Ram-Nek joint gasket at joints of sections.

3.3 BACKFILLING

General: Complete backfill operations of open-cut trenches closely following layout, jointing and bedding of pipe, and after initial inspection and testing are completed.

To minimize local area traffic interruptions, allow no more than 100 feet between pipe laying and point of complete backfilling.

3.4 TESTING

Deflection Testing: Unless specified otherwise, the maximum allowable pipe deflection (reduction in vertical inside diameter) shall be 5%. Deflection tests shall be conducted on each section of sewer main 30 days after the completion of all backfilling operations. The maximum allowable deflection shall be 5%. The test shall consist of passing a 5% deflection mandrel through the entire length of the pipe without the mandrel becoming stuck nor requiring the use of excess force. For 8 inch pipe the mandrel shall have a minimum diameter of 7.2 inches. The mandrel may be floated through the pipe using clean water but must be attached to a string of sufficient strength to allow it to be retrieved if it becomes stuck. This test may be performed in conjunction with pipe flushing. All locations with deflection exceeding 5% shall be excavated and repaired by rebedding or replacement of pipes. Optional devices for testing include calibrated television, photography, sewer ball or deflectometer. To ensure accurate testing, the lines must be thoroughly cleaned.

Leakage Testing: The allowable limit of groundwater infiltration or exfiltration for the entire system shall be in complete accordance with ASTM standards and shall not exceed a limit of 200 gal/inch/diameter/mile/day. An infiltration or exfiltration test shall be performed with a minimum positive head of 2 feet (groundwater table at least two feet above the top of the pipe to be tested).

The test will be made by measuring the infiltration flow of water over a measuring weir set up in the invert of the sewer, or by an alternate method approved by the Engineer a known distance from a temporary bulkhead or other limiting point of infiltration. After the sewer or sewers have been pumped out, and normal infiltration conditions prevail, tests shall be started.

Tests shall run continuously for a period of not less than three (3) hours, with weir readings taken at 20 minute intervals. The Contractor shall make the test. The Engineer shall be notified 48 hours in advance. Where infiltration occurs in excess of the specified amount, the defective pipe or joints shall be located and repaired at the expense of the Contractor. If the defective portions cannot be so located, the Contractor, at his own expense, shall remove and reconstruct as much of the original work as necessary to obtain a sewer within the allowable infiltration limits upon such retesting as necessary.

END OF SECTION 15065

TECHNICAL SPECIFICATIONS FOR GLENDALE FIRE STATION

SECTION 15100-VALVES AND GATES

PART 1 - GENERAL

RELATED DOCUMENTS:

Drawings and general provisions of Contract apply to work of this section.

DESCRIPTION OF WORK:

Extent of valves and gates required by this section is indicated on drawings.

Types of valves and gates specified in this section include the following:

- Gate Valves
- Plug Valves
- Check Valves
- Tapping Valves
- Telescoping Valves
- Mud Valves
- Aluminum Slide Gates
- Stop Gates

Valves furnished as part of factory-fabricated equipment, are specified as part of equipment assembly in other.

QUALITY ASSURANCE:

Manufacturer's Qualifications: Firms regularly engaged in manufacture of valves, of types and sizes required, whose products have been in satisfactory use in similar service for not less than 3 years.

Valve Types: Provide valves of same type by same manufacturer.

Valve Identification: Provide valves with manufacturer's name (or trademark) and pressure rating clearly marked on valve body.

Codes and Standards:

- ANSI Compliance: For face-to-face and end-to-end dimensions of flanged or welded-end valve bodies, comply with ANSI B16.10 "Face to Face and End-to-End Dimensions of Ferrous Valves".

- UL and FM Compliance: Provide valves used in fire protection piping, which are UL-listed and FM approved.

SUBMITTALS:

Product Data: Submit manufacturer's technical product data, including installation instructions for each type of valve. Include pressure drop curve or chart for each type and size of valve. Submit valve schedule showing manufacturer's figure number, size, location, and valve features for each required valve.

Shop Drawings: Submit manufacturer's assembly-type (exploded view) shop drawings for each type of valve, indicating dimensions, weights, materials, and methods of assembly of components.

Maintenance Data: Submit maintenance data and spare parts lists for each type of valve. Include this data, product data, and shop drawings in Maintenance Manual.

PART 2 - PRODUCTS

VALVES:

General: Provide factory-fabricated valves recommended by manufacturer for use in service indicated. Provide valves of types and pressure ratings indicated. Provide proper selection as determined by Installer to comply with installation requirements. Provide end connections which properly mate with pipe, tube, and equipment connections. Where more than one type is indicated, selection is Installer's option.

Pressure sewer shutoff valves are to be full diameter opening and are to be rated for 250 pounds per square inch (psi) minimum.

Buried Valves: Provide 2" square nut operator. For quarter-turn valves 8" and larger, provide gear operator also. Provide one (1) valve key fabricated of carbon steel of suitable length for each four (4) valves of suitable strength.

Exposed Valves: Provide handwheels for all valves except quarter-turn valves, 6" and smaller. Provide lever handle for quarter-turn valves 6" and smaller. Provide one (1) lever handle for each valve pit.

GATE VALVES:

Three Inches and Smaller: Bronze construction with threaded ends or fanged ends.

Over Three Inches: All gate over three inches shall be of the iron body, non-rising bronze stem resilient seat wedge type with fanged, mechanical joint or spigot ends, depending on installation,

furnished with all necessary joint materials. Flanged gate valves shall be provided with 125 lb. American Standard flanges. Valves shall conform to AWWA Specifications C509-80.

Gate valves shall be M & H Valve Co., AWWA C 509, resilient seated gate valve or approved equal.

PLUG VALVES:

Valves shall be of the non-lubricated eccentric type with resilient seat seal unless otherwise specified and shall be furnished with end connections as shown on the plans. Flanged valves shall have flanges in full compliance to ANSI B16.1 Class 125 Standards, including facing, drilling and thickness. Face to face dimensions of flanged valves through 12" size shall be that of standard gate valves. Mechanical joint ends shall be in full conformance to ANSI Standard A21.11.

Port areas for all valves shall be at least 80% of full pipe area.

Valve bodies shall be of ASTM A-126 Class B, cast iron. All exposed nuts, bolts, springs, washers, etc., shall be zinc plated. Resilient seat seals shall be of Buna-N or Neoprene, suitable for use in sewage service.

Seats shall be non-metallic with seat coating thermally bonded and in full conformance to AWWA Standard C550. Valves shall be furnished with permanent corrosion resistant bearing surfaces in the upper and lower journals design to withstand full rated bearing loads and provide long life in sewage service. Valves furnished shall have their internal wetted surfaces protected by nonmetallic coatings factory applied, thermally bonded and in full conformance to AWWA Standard C550.

Nominal valve pressure ratings, body flanges and wall thicknesses shall be in full conformance to ANSI B16.1-1975. Valves shall seal leak-tight against full rated pressure in both directions. Valve seats shall be tested and provide leak-tight shut-off to 175 psi for valves 14" and larger, with pressure in each direction. A hydrostatic test at twice rating shall be performed with plug open to demonstrate overall pressure envelope integrity.

Manual valves shall have lever or gear actuators and tee wrenches, extension stems, floorstands, etc., as indicated on the plans. All manual valves 8" and larger shall be equipped with handwheel actuators. All gearing shall be fully enclosed in a suitable housing and be suitable for running in a lubricant with seals provided on all shafts to prevent entry of dirt and water into the actuator. Actuators shall provide clear indication of valve position. A suitable stop shall be set to provide water tight shut off in the closed position at full rated pressure. All exposed nuts, bolts and washers shall be zinc plated.

Valve actuators for buried or submerged service shall have seals on all shafts and gaskets on the valve and actuator covers to prevent the entry of water. Actuator mounting brackets for buried or submerged service shall be totally enclosed and shall have gasket seals. All exposed nuts, bolts, springs and washers used in buried service shall be electro plated steel.

Valves and actuators shall be as manufactured by DeZurik, Valmatic, M & H, or approved equal.

CHECK VALVES:

Over Three Inches: The check valve over three inches shall be iron-body, bronze-mounted, spring and lever with flanged ends, except as specified herein. All working parts shall be spring-loaded to prevent slamming. The check valves shall be M & H 259 - lever/spring or approved equal.

Under Three Inches: Check valves under three inches shall be screwed or flanged ends, bronze-body, silent check valves as manufactured by Crane Co., No. 37, or approved equal.

FLUSHING HYDRANTS:

Flushing hydrants shall be 2" post-type with one hose nozzle, Aquarius One-O-Two HH 2" as manufactured by Gill Industries, Pensacola, Florida, or approved equal.

TAPPING VALVE AND SLEEVE:

Tapping valves and sleeves shall be ductile iron and used for tie-ins at the locations and of the size shown on the construction plans. The tapping sleeve shall be a full bolt around and shall have a flanged outlet. The tapping valve shall be a flanged mechanical joint valve. Valves shall be M & H Style 3751 or approved equal. The installation of the tapping sleeve shall be on a clean surface and shall have a minimum of 12 pipe diameters to the nearest existing joint. The tapping valve and sleeve shall be mounted and the wet tap made in accordance with the manufacturer's recommendation. The tapping sleeve shall be as manufactured by Ford (FTS coated) or approved equal.

TELESCOPING VALVES:

There shall be furnished and installed by the contractor three (3) Telescoping Valve(s) as manufactured by Vulcan Industries, Waterman Industries, or other prior approved supplier of such equipment.

The telescoping valves described in this specification shall be manufactured with new components of the highest quality available. The following codes and standards shall apply wherever applicable.

- NEMA - NATIONAL ELECTRICAL MANUFACTURERS ASSOCIATION
- CEMA - CANADIAN ELECTRICAL MANUFACTURERS ASSOCIATION
- ASTM - AMERICAN SOCIETY FOR TESTING AND MATERIALS
- AGMA - AMERICAN GEAR MANUFACTURER ASSOCIATION

- ANSI - AMERICAN NATIONAL STANDARD INSTITUTE

Valves shall consist of type (RS-rising stem)(NRS-non-rising stem)(RP-rack and pinion) floorstands. Valves shall have travel as shown on drawings. For greater than 4'0" travel on NRS valves, indicator shall be reduced to 1/2 of travel. On type RS or NRS, valve stem and nut shall be made of brass and shall have Acme thread (4" through 8" shall be 1" diameter), (10" through 16" shall be 1" diameter), (18" through 24" shall be 1-1/4" diameter). All assembly bolts shall be stainless steel.

Floorstands shall be fabricated from 304 Stainless Steel. Handwheels shall be (Cast Alum). All extension stems shall be Schedule 40 stainless steel pipe and terminate at the tube bracket with 6" of thread for field adjustment and be fastened to bracket with double stainless steel nuts and lock washers.

Telescoping tube shall be manufactured from stainless steel and shall be rolled and smooth seam weld 12 gauge stainless steel. Tubes shall be at least 6" longer than travel. Tube bail shall be fabricated stainless steel channel.

Indicator shall be furnished on all units and shall be as follows:

- (RS) Clear plastic stem covers with rule scale.

A galvanized steel mating flange not more than 1/2" larger diameter than the O.D. of slip tube shall be furnished with 3/8" thick neoprene gasket (receiving pipe and flange by others).

Options:

- a. V-notch weirs shall be furnished on opposite sides of tube and shall be (2-1/2" 90 degree).
- b. Scum baffle shall be furnished on tube and shall be 10" high and have 4" clearance between tube and baffle. Baffle shall be 16 gauge stainless steel and held in place by 1/4" x 2" stainless steel bail.

MUD VALVE:

Mud valve shall be of the heavy duty flange type with rising stems. Frame, cover, yoke and stem extension connection shall be cast iron. Stems shall be brass or stainless steel. Lift nuts shall be bronze.

Seating surfaces are to be bronze and flat configuration. Flange drilling on frame will be suitable for mounting to flange per ASA-B-16.1 (125 lbs. drilling).

Gate will be operated by a Tee handle on a standard AWWA 2" valve nut or with stainless steel stem extension to the height required.

When shown, pedestal lifts, stem guides, and wall brackets will be furnished by the manufacturer of the mud valve to make a complete and operable unit.

On rising stem valves, stem guides shall be provided such that the L/r ratio of the unsupported part of the stem shall not exceed 200.

Paint will be as shown under painting specifications.

Valves and accessories shall be Waterman Model MV-11 or approved equal.

ALUMINUM SLIDE GATES:

Aluminum Slide Gates, where shown on the plans or indicated in the specifications shall be Model AC-31 Aluminum Slide Gates with resilient seal as manufactured by Waterman Industries, Inc. or equal.

The gates will be self-contained, rising stem of the flange design with drilling suitable for attachment to 25 or 125 lb. ASI companion flange.

Guide frames shall be of extruded aluminum shape, of sufficient section to carry the operating forces of the gate, and shall have UHMW polyethylene inserts on which the slide assembly travels to minimize friction. A spigot ring will be welded to the guides and have a seating surface at minimum 1-1/2 degree angle to which a resilient Jbulb seal shall be attached or held in place by a substantial section ring.

Dual Headrails (Yokes) shall be welded to the guide rails and so positioned that the slide is removable from the gate. The slide shall be aluminum plate suitable reinforced with extruded structural shapes for the head requirements specified and will not deflect more than 1/360 of the gate width under the design head. Suitable side guides will be welded to the slide, which will travel within the guides, and place the cover in an angle corresponding to the seat surface of the guide frame assembly. A rising stainless steel stem having modified acme type threads shall attach to the slide with a clevis and pin arrangement.

The stem will be designed to have a L/r of 200 or less and to withstand in compression at least twice the rated output of the lift at 40 lb. pull. A suitable handwheel or gear type operator should be mounted on the headrails (yoke) of the gate and will require a maximum 40 lb. pull on the handwheel rim or crank handle to operate the gate.

Flatback gates shall be attached to headwalls with anchor bolts or expansion anchors. Gates shall be installed on the anchors with nuts both behind and on the flange face so as to position the gate without stress or distortion. See manufacturer's installation instructions. Sealing between headwall and gate flange will be by dry-pack non-shrink grout or other suitable mastic sealant.

Spigotback gates will be attached to corrugated metal pipe by field drilling the pipe with 7/16" holes and secured with 3/8" stainless steel bolts, maximum spacing to be 8" on circumference of

pipe. Sealing between pipe and gate will be made with suitable mastic sealing material to assure water tightness at this joint.

The gate, when installed, shall have no more than 0.05 gpm leakage per foot of sealing periphery for seating or unseating heads up to 15 feet.

Aluminum and stainless steel will be mill finish. Paint for lifts will be manufacturer's standard (or prime paint as specified elsewhere).

Material:

- X Aluminum Plate and Shapes - ASTM-B211 Alloy 6061-T6
- X J-Bulb Seal - Neoprene ASTM-CB610-625, D-2000
- X Fasteners - ASTM F593 & F594 Type 304 or 316
- X Stem - ASTM A-276 Type 304 and 316
- X Handwheel Lift - Cast iron ASTM A-126 CL B W/manganese bronze lift nut per ASTM B-584 alloy 865
- X Enclosed Gear Lift - Cast iron ASTM A-126 CL B W/manganese bronze lift nut per ASTM B-584 alloy 865

STOP GATES:

The fabricated aluminum stop gates, where shown on the drawings or indicated in the specifications, shall be furnished with aluminum frames with the guides designed to embed in the concrete or to mount to the face of the concrete. The gates shall be manufactured by Armtec, or Engineer approved equal.

The stop gates shall be the product of a manufacturer having at least ten years experience in the design and manufacture of low leakage stop gates under similar design conditions. Stop gates that are the product of a metals fabricator will not be acceptable. All welds shall be performed by qualified, experienced welders.

Maximum allowable leakage for the stop gates shall be as per AWWA (American Water Works Association) standards.

In addition to submittal information required by other sections of these specifications, the stop gate manufacturer may be required to submit design calculations and supporting data for all gates showing stresses, loads and deflection of critical parts under the design head conditions.

The frame shall consist of 1/4" minimum thickness extruded aluminum, alloy 6061-T6. The embedded members of the extruded frame shall be at least 1/8" thickness. The guides and invert shall be arranged for concrete embedment. An aluminum member shall be welded or bolted to the top of each frame to prevent distortion during shipment and installation. The member shall be removed by the contractor after installation. A soft closed cell neoprene gasket shall be supplied by the manufacturer for installation between the aluminum frame and the concrete wall.

The frame guides shall incorporate black UV treated low density extruded poly side seals press fitted into the extruded frame and fastened with #8 stainless steel self tapping flat head screws on both the upstream and downstream sides of the slide. Each seat/seal will be shaped to provide two bearing surfaces and two sealing edges. Neoprene seals shall be attached to the guides, if necessary, to meet leakage criteria. A removable neoprene seal shall be contained in the invert member.

The slide shall be a minimum thickness of 1/4" aluminum plate, alloy 5083 or 6061-T6. The slide shall be reinforced with stiffeners as required so that under the maximum head, the slide will not deflect more than 1/16" of its width and stress is limited to 7,000 psi. The slide shall be provided with two slotted handles for operating the stop plate from the frame.

All aluminum in contact with concrete will have a heavy shop coat of bitumastic paint.

VALVE BOXES:

Cast-iron boxes shall be provided for all underground valve installations. They shall consist of a base covering the operating nut and head of the valve, vertical shaft, at least 5-1/4 inches in diameter, and a top section extending to a point even with the finished ground surface. Provide a cast-iron cover marked "WATER" or "SEWER" as appropriate and placed concentrically over the operating nut. The valve boxes shall be Clow F-2454 screw-type valve box USF 7500 or approved equal.

VALVE FEATURES:

General: Provide valves with features indicated and, where not otherwise indicated, provide proper valve features as determined by Installer for installation requirements. Comply with ASME B31.9 for building services piping, and ASME B31.1 for power piping.

Flanged: Valve flanges complying with ANSI B16.1 (cast iron), ANSI B16.5 (steel), or ANSI B16.24 (bronze).

Threaded: Valve ends complying with ANSI B2.1.

PART 3 - EXECUTION

INSTALLATION:

General: Except as otherwise indicated, comply with the following requirements:

- Install valves where required for proper operation of piping and equipment, including valves in branch lines where necessary to isolate sections of piping. Locate valves so as to be accessible and so that separate support can be provided when necessary.

- Install valves with stems pointed up, in vertical position where possible, but in no case with stems pointed downward from horizontal plane unless unavoidable. Install valve drains with hose-end adapter for each valve that must be installed with stem below horizontal plane.

Insulation: Where insulation is indicated, install extended-stem valves, arranged in proper manner to receive insulation.

ADJUSTING AND CLEANING:

Valve Adjustment: After piping systems have been tested and put into service, but before final testing, adjusting, and balancing, inspect each valve for possible leaks. Adjust or replace packing to stop leaks, replace valve if leak persists.

Cleaning: Clean factory-finished surfaces. Repair any marred or scratched surfaces with manufacturer's touch-up paint.

TECHNICAL SPECIFICATIONS FOR GLENDALE FIRE STATION SECTION 15120-PIPING SPECIALTIES

PART 1 - GENERAL

RELATED DOCUMENTS:

Drawings and general provisions of Contract, including General and Special Conditions, apply to work of this section.

QUALITY ASSURANCE:

Manufacturer's Qualifications: Firms regularly engaged in manufacture of piping specialties, of types and sizes required, whose products have been in satisfactory use in similar service for not less than 3 years.

PART 2 - PRODUCTS

VALVE BOXES:

Cast-iron valve boxes shall be provided for all underground valve installations. They shall consist of a base covering the operating nut and head of the valve, a vertical shaft, at least 5-1/4 inches in diameter, and a top section extending to a point even with the finished ground surface. Provide a cast-iron cover marked "WATER" and placed concentrically over the operating nut. The valve boxes shall be Clow F-2454 screw-type valve box, USF 7500 or approved equal.

SERVICE CLAMPS:

Service clamps shall be Clow-Vega Model F-6350 as manufactured by Clow, Wichita Falls, Texas, Dresser Style 194 as manufactured by Dresser Manufacturing Company, Bradford, Pennsylvania, or approved equal.

STRAINERS:

All strainers shall be Y type with galvanized iron bodies with a bronze cylindrical screen. The strainers shall be Mueller No. H-9330 or approved equal.

FIRE HYDRANTS:

All fire hydrants shall be 5-1/4 inch hydrants with two 2-1/2 inch connection and one pumper connection designed for 150 psi working pressure, and shall conform to the requirements of AWWA C-502-73 (Latest Revision). Hydrants shall have mechanical joint inlets, shall be for a

3-foot bury, and shall have a compression type main valve which opens against pressures. The hydrant main valve operating parts, including valve seal, valve seal insert, cross arm, and upper valve washer shall be all bronze, meeting either of the following ASTM B-61, or B-150 per C-502.

The barrel section of the hydrant shall be made in two or more sections, with a flange located at least two inches above the finished grade line, and provided with a break flange, flange clips or lugs at ground line. Undercut bolts for the break connection are not acceptable.

The hydrants shall open left (counterclockwise). They shall have pentagon shaped operating nuts and cap nuts measuring 1-1/2" from pint to flat. The bonnet shall be of dry type top design. The hydrants stem shall have "O" ring seals, and stem threads and bearing shall be protected with automatic self-oiling or grease case lubricant systems. Hydrants having stem thread (upper or lower) that are constantly exposed or immersed in water are not acceptable.

All fire hydrants shall be M & H Style 129, Muller 423, or Clow F-2500, no substitutions. Color shall be red. One fire hydrant wrench shall be supplied for every four fire hydrants provided.

TAPPING VALVE AND SLEEVE:

Tapping valves and sleeves shall be ductile iron and used for tie-ins at the locations and of the size shown on the construction plans. The tapping sleeve shall be a full bolt around and shall have a flanged outlet. The tapping valve shall be a flanged to mechanical joint valve. Valves shall be the resilient seat type similar in construction to the gate valves specified herein. The tapping valve and sleeve shall be as manufactured by M & H Style 3751 or approved equal. The installation of the tapping sleeve shall be on a clean surface and shall have a minimum of 12 pipe diameters to the nearest existing joint. The tapping valve and sleeve shall be mounted and the wet tap made in accordance with the manufacturer's recommendation. Tapping sleeves shall be Ford FTS coated or approved equal.

INSULATION:

All exterior above grade piping, valves, and fittings shall be insulated with one-inch thick fiberglass insulation. The insulation shall be factory molded into semi cylindrical half section in three-foot lengths. A protective covering of 0.020-inch thick smooth aluminum shall be rolled to fit the outer diameter of the insulation and secured with a minimum of two sheet-metal screws at each lap.

CORPORATION STOPS:

Corporation stops shall be Ford Model No. F-1000 or approved equal. Inlets shall have iron pipe threads and outlets shall have compression connections.

CURB STOPS:

Curb stops/meter coupling shall be Ford Model B43-232W (3/4") or B43-444W (1") or equal. Inlets shall have compression connection and outlets shall have iron pipe threads.

HOSE BIBBS AND SAMPLE TAPS:

Hose bibbs and sample taps shall be Crane No. 58 or approved equal. Hose threads shall be removed from sample taps.

VACUUM BREAKERS:

The vacuum breakers shall have a bronze body with brass internal trim, silicone disc and plastic float. The vacuum breakers shall be as manufactured by Rain Bird, AVB Series, sizes 3/4" through 3", or an equal. All hose bibbs to be installed with vacuum breakers.

PART 3 - EXECUTION (Not Applicable)

TECHNICAL SPECIFICATIONS FOR GLENDALE FIRE STATION

SECTION 334200 – STORMWATER CONVEYANCE

PART 1 - GENERAL

1.1 RELATED DOCUMENTS

- A. Drawings and general provisions of the Contract, including General and Supplementary Conditions and Division 01 Specification Sections, apply to this Section.
- B. Florida Department of Transportation Standard Specifications for Road and Bridge Construction, current edition. Hereafter referred to as “FDOT Standard Specifications”.

1.2 SUMMARY

- A. Section Includes:
 - 1. Round corrugated HDPE pipe.
 - 2. PVC pipe and fittings.
 - 3. Concrete pipe and fittings.
 - 4. Cleanouts.
 - 5. Drains.
 - 6. Manholes.
 - 7. Catch basins.
 - 8. Stormwater inlets.
 - 9. Stormwater detention structures.
 - 10. Pipe outlets.
 - 11. RipRap

1.3 DEFINITIONS

- A. HDPE: High density polyethylene
- B. PVC: Polyvinyl chloride plastic.
- C. RCP: Reinforced Concrete Pipe

1.4 ACTION SUBMITTALS

- A. Product Data: For each type of product.
- B. Shop Drawings:
 - 1. Manholes: Include plans, elevations, sections, details, frames, and covers.
 - 2. Catch basins and stormwater inlets. Include plans, elevations, sections, details, frames, covers, and grates.
 - 3. Stormwater Detention Structures: Include plans, elevations, sections, details, frames, covers, design calculations, and concrete design-mix reports.

1.5 QUALITY ASSURANCE

- A. Manufacturer's Qualifications: Firms regularly engaged in the manufacture of pipes and pipe fittings of types and sizes required, whose products have been in satisfactory use in similar service for not less than 5 years.
- B. Piping materials shall bear label, stamp, or other markings of specified testing agency.

1.6 DELIVERY, STORAGE, AND HANDLING

- A. Do not store plastic manholes, pipe, and fittings in direct sunlight.
- B. Protect pipe, pipe fittings, and seals from dirt and damage.
- C. Handle manholes in accordance with manufacturer's written rigging instructions.
- D. Handle catch basins and stormwater inlets in accordance with manufacturer's written rigging instructions.

1.7 FIELD CONDITIONS

- A. Interruption of Existing Storm Drainage Service: Do not interrupt service to facilities occupied by Owner or others unless permitted under the following conditions and then only after arranging to provide temporary service in accordance with requirements indicated:
 - 1. Notify and Owner no fewer than **two** days in advance of proposed interruption of service.
 - 2. Do not proceed with interruption of service without Owner's written permission.

PART 2 - PRODUCTS

2.1 HDPE PIPE AND FITTINGS

- A. Source Limitations: Obtain ABS pipe and fittings from single manufacturer.
- B. HDPE pipe and fittings shall conform to the requirements of AASHTO M-294 and AASHTO MP7, Type S&D.

2.2 CORRUGATED-PE PIPE AND FITTINGS

- A. Source Limitations: Obtain corrugated-PE pipe and fittings from single manufacturer.
- B. Corrugated-PE Drainage Pipe and Fittings NPS 3 to NPS 10 (DN 80 to DN 250): AASHTO M 252, Type S, with smooth waterway for coupling joints.
- C. Corrugated-PE Pipe and Fittings NPS 12 to NPS 60 (DN 300 to DN 1500): AASHTO M 294, Type S, with smooth waterway for coupling joints.
- D. Corrugated-PE Silttight Couplings: PE sleeve with ASTM D1056, Type 2, Class A, Grade 2 gasket material that mates with pipe and fittings.

- E. Corrugated-PE Soiltight Couplings: AASHTO M 294, corrugated, matching pipe and fittings.

2.3 PVC PIPE AND FITTINGS

- A. Source Limitations: Obtain PVC pipe and fittings from single manufacturer.
- B. NSF Marking: Comply with NSF 14, "Plastics Piping Systems Components and Related Materials," for plastic piping components. Include marking with "NSF-drain" for plastic storm drain and "NSF-sewer" for plastic storm sewer piping.
- C. PVC Corrugated Sewer Piping:
 - 1. Pipe: ASTM F949, PVC, corrugated pipe with bell-and-spigot ends for gasketed joints.
 - 2. Fittings: ASTM F949, PVC molded or fabricated, socket type.
 - 3. Gaskets: ASTM F477, elastomeric seals.
- D. PVC Profile Sewer Piping:
 - 1. Pipe: ASTM F794, PVC profile, gravity sewer pipe with bell-and-spigot ends for gasketed joints.
 - 2. Fittings: ASTM D3034, PVC with bell ends.
 - 3. Gaskets: ASTM F477, elastomeric seals.
- E. PVC Gravity Sewer Piping:
 - 1. Pipe and Fittings: ASTM F679, T-1 wall thickness, PVC gravity sewer pipe with bell-and-spigot ends and with integral ASTM F477, elastomeric seals for gasketed joints.

2.4 CONCRETE PIPE AND FITTINGS

- A. Source Limitations: Obtain concrete pipe and fittings from single manufacturer.
- B. Reinforced-Concrete Sewer Pipe and Fittings: ASTM C76 (ASTM C76M).
 - 1. Bell-and-spigot or tongue-and-groove ends and gasketed joints with ASTM C443 (ASTM C443M), rubber gaskets.
 - 2. Class III, Wall B.
 - 3. Class IV, Wall B.
 - 4. Class V, Wall B.

2.5 NONPRESSURE TRANSITION COUPLINGS

- A. Comply with ASTM C1173, elastomeric, sleeve-type, reducing or transition coupling, for joining underground nonpressure piping. Include ends of same sizes as piping to be joined, and corrosion-resistant-metal tension band and tightening mechanism on each end.
- B. Sleeve Materials:
 - 1. For Concrete Pipes: ASTM C443 (ASTM C443M), rubber.
 - 2. For Plastic Pipes: ASTM F477, elastomeric seal or ASTM D5926, PVC.

3. For Dissimilar Pipes: ASTM D5926, PVC or other material compatible with pipe materials being joined.

C. Unshielded, Flexible Couplings:

1. Source Limitations: Obtain unshielded, flexible couplings from single manufacturer.
2. Description: Elastomeric sleeve with stainless-steel shear ring and corrosion-resistant-metal tension band and tightening mechanism on each end.

D. Shielded, Flexible Couplings:

1. Source Limitations: Obtain shielded, flexible couplings from single manufacturer.
2. Description: ASTM C1460, elastomeric or rubber sleeve with full-length, corrosion-resistant outer shield and corrosion-resistant-metal tension band and tightening mechanism on each end.

E. Ring-Type, Flexible Couplings:

1. Source Limitations: Obtain ring-type, flexible couplings from single manufacturer.
2. Description: Elastomeric compression seal with dimensions to fit inside bell of larger pipe and for spigot of smaller pipe to fit inside ring.

2.6 CLEANOUTS

A. PVC Cleanouts:

1. Source Limitations: Obtain PVC cleanouts from single manufacturer.
2. Description: PVC body with PVC threaded plug. Include PVC sewer pipe fitting and riser to cleanout of same material as sewer piping.

2.7 MANHOLES

- A. In accordance with FDOT Standard Specifications.

2.8 CONCRETE

- A. General: Cast-in-place concrete in accordance with ACI 318, ACI 350 , and the following:

1. Cement: ASTM C150/C150M, Type II.
2. Fine Aggregate: ASTM C33/C33M, sand.
3. Coarse Aggregate: ASTM C33/C33M, crushed gravel.
4. Water: Potable.

- B. Portland Cement Design Mix: 4000 psi (27.6 MPa) minimum, with 0.45 maximum water/cementitious materials ratio.

1. Reinforcing Fabric: ASTM A1064/A1064M, steel, welded wire fabric, plain.
2. Reinforcing Bars: ASTM A615/A615M, Grade 60 (420 MPa) deformed steel.

- C. Ballast and Pipe Supports: Portland cement design mix, 3000 psi (20.7 MPa) minimum, with 0.58 maximum water/cementitious materials ratio.

1. Reinforcing Fabric: ASTM A1064/A1064M, steel, welded wire fabric, plain.
2. Reinforcing Bars: ASTM A615/A615M, Grade 60 (420 MPa) deformed steel.

2.9 CATCH BASINS

- A. In accordance with Manufacturer's and FDOT Standard Specifications.

2.10 STORMWATER INLETS

- A. In accordance with Manufacturer's and FDOT Standard Specifications.

2.11 STORMWATER DETENTION STRUCTURES

- A. Cast-in-Place Concrete, Stormwater Detention Structures: Constructed of reinforced-concrete bottom, walls, and top; designed in accordance with ASTM C890 for A-16 (AASHTO HS20-44), heavy-traffic, structural loading; of depth, shape, dimensions, and appurtenances indicated.

1. Ballast: Increase thickness of concrete as required to prevent flotation.

- B. Manhole Frames and Covers: ASTM A536, Grade 60-40-18, ductile-iron castings designed for heavy-duty service. Include 24-inch ID by 7- to 9-inch riser with 4-inch- minimum width flange, and 26-inch-diameter cover. Include indented top design with lettering cast into cover, using wording equivalent to "STORM SEWER."

2.12 PIPE OUTLETS

- A. Mitered End Sections: In accordance with FDOT Standard Specifications.
- B. Head Walls: Cast-in-place reinforced concrete, with apron and tapered sides.

2.13 RIPRAP

- A. Class 2 RipRap
 1. Riprap shall be durable stone with a minimum weight of 165 pounds per cubic foot. Riprap gradation shall conform to the requirements of Class 2 riprap, Alabama Highway Department Standard Specifications for Highway Construction, Section 814 (current edition).
 2. Stone for Class 2 Riprap shall consist of reasonably well-graded durable rock with a median stone size of 80 pounds and not over 10 percent larger than 200 pounds. There shall be sufficient small stones and spalls to approximately fill the void between the larger stones.

PART 3 - EXECUTION

3.1 EARTHWORK

- A. Excavation, trenching, and backfilling are specified in Section 312000 "Earth Moving."

3.2 PIPING INSTALLATION

- A. General Locations and Arrangements: Drawing plans and details indicate general location and arrangement of underground storm drainage piping. Location and arrangement of piping layout take into account design considerations. Install piping as indicated, to extent practical. Where specific installation is not indicated, follow piping manufacturer's written instructions.
- B. Install piping beginning at low point, true to grades and alignment indicated with unbroken continuity of invert. Place bell ends of piping facing upstream. Install gaskets, seals, sleeves, and couplings in accordance with manufacturer's written instructions for use of lubricants, cements, and other installation requirements.
- C. Install manholes for changes in direction unless fittings are indicated. Use fittings for branch connections unless direct tap into existing sewer is indicated.
- D. Install proper size increasers, reducers, and couplings where different sizes or materials of pipes and fittings are connected. Reducing size of piping in direction of flow is prohibited.
- E. When installing pipe under streets or other obstructions that cannot be disturbed by tunneling, jacking, or a combination of both
- F. Install gravity-flow, nonpressure drainage piping in accordance with the following:
 - 1. Install piping pitched down in direction of flow.
 - 2. Install piping **NPS 6** and larger with restrained joints at tee fittings and at changes in direction. Use corrosion-resistant rods, pipe or fitting manufacturer's proprietary restraint system, or cast-in-place concrete supports or anchors.
 - 3. Install piping with 12 inch- minimum cover.
 - 4. Install PE corrugated sewer piping in accordance with ASTM D2321.
 - 5. Install PVC sewer piping in accordance with ASTM D2321 and ASTM F1668.
 - 6. Install PVC profile gravity sewer piping in accordance with ASTM D2321 and ASTM F1668.
 - 7. Install reinforced-concrete sewer piping in accordance with ASTM C1479 and ACPA's "Concrete Pipe Installation Manual."
 - 8. Installation of HDPE pipe shall be in accordance with ASTM recommended practice D-2323, AASHTO section 30, or in accordance with FDOT Standard Specifications.

3.3 PIPE JOINT CONSTRUCTION

- A. Join gravity-flow, nonpressure drainage piping in accordance with the following:
 - 1. Join corrugated-PE piping in accordance with ASTM D3212 for push-on joints.
 - 2. Join PVC corrugated sewer piping in accordance with ASTM D2321 for elastomeric-seal joints.
 - 3. Join PVC sewer piping in accordance with ASTM D2321 and ASTM D3034 for elastomeric-seal joints or ASTM D3034 for elastomeric-gasketed joints.
 - 4. Join PVC profile gravity sewer piping in accordance with ASTM D2321 for elastomeric-seal joints or ASTM F794 for gasketed joints.
 - 5. Join reinforced-concrete sewer piping in accordance with ACPA's "Concrete Pipe Installation Manual" for rubber-gasketed joints.
 - 6. Join dissimilar pipe materials with nonpressure-type flexible couplings.
- B. Join force-main pressure piping in accordance with the following:

1. Join ductile-iron pressure piping in accordance with AWWA C600 or AWWA M41 for push-on joints.
2. Join ductile-iron special fittings in accordance with AWWA C600 or AWWA M41 for push-on joints.
3. Join PVC pressure piping in accordance with AWWA M23 for gasketed joints.
4. Join PVC water-service piping in accordance with ASTM D2855 for solvent-cemented joints.
5. Join dissimilar pipe materials with pressure-type couplings.

3.4 DRAIN INSTALLATION

- A. Install type of drains in locations indicated.
 1. Use Light-Duty, top-loading classification drains in **earth or unpaved foot-traffic** areas.
 2. Use Medium-Duty, top-loading classification drains in **paved foot-traffic** areas.
 3. Use Heavy-Duty, top-loading classification drains in **vehicle-traffic service** areas.
- B. Embed drains in 4-inch- minimum concrete around bottom and sides.
- C. Fasten grates to drains if indicated.
- D. Set drain frames and covers with tops flush with pavement surface.
- E. Assemble trench sections with flanged joints.

3.5 MANHOLE INSTALLATION

- A. General: Install manholes, complete with appurtenances and accessories indicated.
- B. Install precast concrete manhole sections with sealants in accordance with ASTM C891.
- C. Where specific manhole construction is not indicated, follow manhole manufacturer's written instructions.
- D. Set tops of frames and covers flush with finished surface of manholes that occur in pavements. Set tops **3** inches above finished surface elsewhere unless otherwise indicated.

3.6 CATCH BASIN INSTALLATION

- A. Construct catch basins to sizes and shapes indicated.
- B. Set frames and grates to elevations indicated.

3.7 STORMWATER INLET AND OUTLET INSTALLATION

- A. Construct inlet head walls, aprons, and sides of reinforced concrete, as indicated.
- B. Construct riprap of broken stone, as indicated.
- C. Install outlets that spill onto grade, anchored with concrete, where indicated.

- D. Install outlets that spill onto grade, with mitered end sections that match pipe, where indicated.
- E. Construct energy dissipaters at outlets, as indicated.

3.8 RIPRAP

A. Subgrade Preparation

1. The subgrade surfaces on which the rock riprap, filter or bedding is to be placed shall be cut or filled and graded to the lines and grades shown on the drawings. When fill to subgrade line is required, it shall consist of approved materials and shall conform to the requirements of the specified class of fill.
2. Rock riprap, filter or bedding shall not be placed until the foundation preparation is completed and the subgrade surfaces have been inspected and approved by the Engineer.

3.9 CONCRETE PLACEMENT

- A. Place cast-in-place concrete in accordance with ACI 318.

3.10 CONNECTIONS

A. Make connections to existing piping and underground manholes.

1. Use commercially manufactured wye fittings for piping branch connections. Remove section of existing pipe; install wye fitting into existing piping; and encase entire wye fitting, plus 6-inch overlap, with not less than 6 inches of concrete with 28-day compressive strength of 3000 psi.
2. Make branch connections from side into existing piping, NPS 4 to NPS 20. Remove section of existing pipe, install wye fitting into existing piping, and encase entire wye with not less than 6 inches (150 mm) of concrete with 28-day compressive strength of 3000 psi (20.7 MPa).
3. Make branch connections from side into existing piping, NPS 21 or larger, or to underground manholes and structures by cutting into existing unit and creating an opening large enough to allow 3 inches of concrete to be packed around entering connection. Cut end of connection pipe passing through pipe or structure wall to conform to shape of and be flush with inside wall unless otherwise indicated. On outside of pipe, manhole, or structure wall, encase entering connection in 6 inches of concrete for minimum length of 12 inches to provide additional support of collar from connection to undisturbed ground.
 - a. Use concrete that will attain a minimum 28-day compressive strength of 3000 psi unless otherwise indicated.
 - b. Use epoxy-bonding compound as interface between new and existing concrete and piping materials.
4. Protect existing piping, manholes, and structures to prevent concrete or debris from entering while making tap connections. Remove debris or other extraneous material that may accumulate.

3.11 IDENTIFICATION

- A. Materials and their installation are specified in Section 312000 "Earth Moving." Arrange for installation of green warning tape directly over piping and at outside edge of underground structures.

1. Use detectable warning tape over ferrous piping.
2. Use detectable warning tape over nonferrous piping and over edges of underground structures.

3.12 FIELD QUALITY CONTROL

- A. Inspect interior of piping to determine whether line displacement or other damage has occurred. Inspect after approximately 24 inches of backfill is in place, and again at completion of Project.
 1. Submit separate reports for each system inspection.
 2. Defects requiring correction include the following:
 - a. Alignment: Less than full diameter of inside of pipe is visible between structures.
 - b. Deflection: Flexible piping with deflection that prevents passage of ball or cylinder of size not less than 92.5 percent of piping diameter.
 - c. Damage: Crushed, broken, cracked, or otherwise damaged piping.
 - d. Infiltration: Water leakage into piping.
 - e. Exfiltration: Water leakage from or around piping.
 3. Replace defective piping using new materials, and repeat inspections until defects are within allowances specified.
 4. Reinspect and repeat procedure until results are satisfactory.
- B. Test new piping systems, and parts of existing systems that have been altered, extended, or repaired, for leaks and defects.
 1. Do not enclose, cover, or put into service before inspection and approval.
 2. Test completed piping systems in accordance with requirements of authorities having jurisdiction.
 3. Schedule tests and inspections by authorities having jurisdiction with at least 24 hours' advance notice.
 4. Submit separate report for each test.
 5. Gravity-Flow Storm Drainage Piping: Test in accordance with requirements of authorities having jurisdiction, UNI-B-6, and the following:
 - a. Exception: Piping with soiltight joints unless required by authorities having jurisdiction.
 - b. Option: Test plastic piping in accordance with ASTM F1417.
- C. Leaks and loss in test pressure constitute defects that must be repaired.
- D. Replace leaking piping using new materials, and repeat testing until leakage is within allowances specified.

3.13 CLEANING

- A. Clean interior of piping of dirt and superfluous materials. Flush with potable water.

END OF SECTION 334200

APPENDIX A
General Vicinity Map and Location Maps

APPENDIX B
Geotechnical Report



MAGNUM ENGINEERING INC
GEOTECHNICAL ENGINEERING CONSULTANTS

GEOTECHNICAL ENGINEERING REPORT

**GLENDALE FIRE DEPARTMENT
WALTON COUNTY, FLORIDA**

PREPARED FOR:

**MR. RUDOLPH MALL, P.E.
DEWBERRY ENGINEERS, INC.
877 CR 393 NORTH
SANTA ROSA BEACH, FLORIDA 32459**

**429 FLORIDA AVENUE
LYNN HAVEN, FLORIDA 32444
TELEPHONE (850) 258.0994**

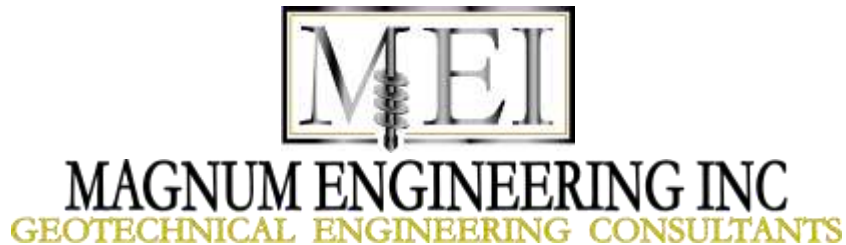

July 25, 2023

Mr. Rudolph Mall, P.E.
Dewberry Engineers, Inc.
877 CR 393 North
Santa Rosa Beach, Florida 32459

SUBJECT: Glendale Fire Department – Geotechnical Services
Walton County, Florida
Project Number: M123-109-195

Dear Mr. Mall:

This letter forwards the results of our Geotechnical exploration for the proposed development. Our exploration consisted of Two (2) 25-foot deep Standard Penetration (SPT) borings in the proposed building footprint, Three (3) 15-foot deep power auger borings in the proposed pavement areas, and One (1) Double Ring Infiltrometer Test (DRI) and One (1) 15-foot deep power auger boring in the proposed stormwater management area. The subsurface exploration was conducted to provide information needed in the design of an effective foundation system and pavement area(s) for the referenced development, as well as to provide soil related information in the stormwater management area to aid in the design of an effective design in accordance with ERP and/or local municipal regulations.

The following report presents the results of our study as well as our evaluation and recommendations pertaining to the geotechnical aspects of the project. Upon completion of our field testing, the samples were brought back to the office for visual inspection, classification, and analysis by our engineering staff.

Project Information

The subject site is located east of County Highway 83 and north of State Road 2 in Glendale, Florida. At the time of our exploration, the site was undeveloped and had recently been cleared. Based upon topographic information provided, the site sloped downward from south to north from a high elevation of roughly +275 FT MSL to a low of +254 FT MSL. The site was easily accessible with our truck mounted drill rig.

The proposed construction will consist of a single-story pre-engineered metal building, associated pavement and a stormwater retention area. We anticipate approximately 4 feet of fill will be required to achieve the proposed finish floor elevation (+271.0 FT). No structural information had been provided at the writing of this report, however, we have assumed wall loads to be less than 2 kips per linear foot and maximum isolated column loads not to exceed 40 kips.

If any of the above information is incorrect, please inform Magnum Engineering, Inc. so that we can review and update our recommendations, as needed.

Subsurface Conditions

Figure #1 shows the Boring Location Plan and Figure #2 shows the Logs of Borings for Standard Penetration Test Borings B-1 and B-2 and hand auger borings HA-1 through HA-4. The test locations were established in the field using a 100-foot tape and estimating right angles with reference to existing landmarks, thus, the test location should be considered approximate.

Building Borings

The building borings (B-1 through B-4) generally encountered loose to dense clayey fine sands from the existing ground surface to approximately 18 feet below existing grade underlain by medium dense to dense slightly silty fine sands to the boring termination depth of 25 feet below existing grade.

Pavement and Stormwater Pond Borings

The power auger borings (PA-1 through PA-4) generally encountered clayey fine sands from the ground surface to the bottom of the 15-foot deep power borings.

The above subsurface descriptions are of a generalized nature, provided to highlight the major soil strata encountered. The Logs of Boring should be reviewed for specific subsurface conditions at each boring location. The stratifications shown on the Logs of Boring represent the subsurface conditions at the actual boring locations only, and variations in the subsurface conditions can and may occur between boring locations and should therefore be expected. The stratifications represent the approximate boundary between subsurface materials, and the transitions between strata may be gradual.

Please refer to the attached Logs of Boring presented as Figure #2 for a detailed description of the subsurface conditions encountered.

Groundwater Conditions

Groundwater was encountered only in borings B-1 and B-2 between 16.3 and 17.3 feet below existing grade at the time of drilling (July 3, 2023), which was during a period of above normal seasonal rainfall. Groundwater levels will fluctuate with rainfall and could vary several feet during typical seasonal fluctuations. Larger fluctuations are possible under severe weather conditions.

We recommend that the Contractor verify the actual groundwater levels at the time of construction to determine potential impacts groundwater will have on construction procedures.

CONCLUSIONS AND RECOMMENDATIONS

General

The following geotechnical related design recommendations have been developed on the basis of the previously described project characteristics and subsurface conditions encountered. If there are any changes in these project criteria, including project location on the site, a review should be made by Magnum Engineering to determine if modifications to the recommendations are warranted.

Once final design plans and specifications are available, a general review by Magnum Engineering is recommended as a means to check that the evaluations made in preparation of this report are correct and that earthwork and foundation recommendations are properly interpreted and implemented

Site Preparation

Initially, the site should be cleared and grubbed of surface vegetation/organics. As a minimum, it is recommended the clearing operations extend at least five (5) feet beyond the development perimeter.

Engineered Fill

All fill used to raise the building area to final grades should consist of sandy soils with less than 15 percent passing the No. 200 sieve. These soils should be free of rubble, organics, clay, debris and other unsuitable material. Fill should be placed in lifts on the order of 12 inches or less (in loose thickness) and compacted to 95 percent of the soil's Modified Proctor maximum dry density, per ASTM D-1557.

Foundations

With proper subgrade preparation and compaction/densification as described herein, the site soils should be capable of supporting the proposed structure on shallow foundations. The existing near surface soils and fill soils should be prepared as previously recommended to improve foundation support and reduce total and differential settlements.

Based on the anticipated construction and site preparation requirements recommended herein, it is our opinion that the building can be supported on shallow foundations designed for a **net maximum allowable bearing pressure of 2,500 pounds per square foot (psf)**. The following geotechnical related recommendations should be used for design and construction of the foundations.

- The foundation and floor slab should bear on properly improved existing subgrade or on properly placed and compacted cohesionless (sand) fill.
- The soils to a depth of one foot below the footings and floor slabs and all new fill should be compacted to 95 percent of the soil's Modified Proctor (ASTM D-1557) density.
- Exterior footings should be embedded so that the bottom of the foundation is a minimum of 18 inches below the adjacent compacted grades.
- Strip or wall footings should be a minimum of 18 inches wide and pad or column footings should be a minimum of three feet wide. The minimum footing sizes should be used regardless of whether or not the foundation loads and allowable bearing pressures dictate a smaller size.
- All footings should be constructed in a "dry" fashion.
- Structural elements should be centered on the footings such that the load is transferred evenly unless the footings are proportioned for eccentric loads.

Settlement

The settlement of shallow foundations supported on sandy soils should occur rapidly after loading. The majority of expected settlement should occur during construction as dead loads are imposed. Total settlements of footings are **estimated to be less than 1 inch**, with differential settlement on the order of 50 percent of the total settlements. Total and differential settlements of these magnitudes are usually considered tolerable for the anticipated construction; however, the tolerance of the proposed structures to the predicted total and differential settlements should be confirmed by the structural engineer.

Ground Floor Slab

The ground floor slab can be safely supported as a slab-on-grade. In this regard, it is recommended that the ground floor slab be "floating," that is, generally ground supported and not rigidly connected to walls or foundations. This is to minimize the possibility of cracking and displacement of the floor slab because of differential movements between the slab and the foundation.

The subgrade should be covered by an effective vapor barrier to reduce the loss of water from the plastic concrete into the subgrade soils and to reduce the possibility of slab dampness due to moisture.

Pavements

Initially, the pavement areas should be cleared, grubbed, and stripped of topsoil and other deleterious material (i.e., concrete pavement). Special care should be taken to ensure that all stumps, root systems and peaty soils (if present) are removed from beneath the proposed pavement areas.

Prior to placing fill soils, where applicable, the top of the ground surface should be compacted to a minimum soil density of 95% of the Modified Proctor Test (ASTM D1557). Structural fill soils should be placed in maximum 12-inch lifts and compacted to a minimum soil density of 95% of the Modified Proctor Test (ASTM D1557). The top 12 inches of subgrade should be compacted to a minimum soil density of 98% of the Modified Proctor Test (ASTM D1557). The top 12 inches of subgrade should have a minimum LBR value of 40. We recommend that structural fill soils, where planned, have a minimum LBR of 40.

Based on the subsurface conditions encountered in the test borings, we recommend using a graded aggregate base (i.e., limerock or crushed concrete). The base course should be compacted to a minimum soil density of 98% of the Modified Proctor Test (ASTM D1557).

Without benefit of traffic loads, volumes, and serviceability parameters, a pavement section cannot be designed. However, typical parking lots in the local area generally consist of a minimum of 1½ inches of FDOT Superpave Mix SP-12.5 or SP-9.5 asphaltic concrete and a minimum of 6 inches of base. Moderate duty traffic areas (e.g., main entrance areas) typically have a minimum pavement section consisting of 2 inches of FDOT Superpave Mix SP-12.5 asphaltic concrete and 8 inches of base. The above sections represent minimum thicknesses representative of typical, local construction practices, and as such periodic maintenance should be anticipated. All pavement materials and construction procedures should conform to FDOT and/or appropriate city or county requirements.

Preparation of the subgrade soils for the parking and drive lanes should be prepared in general accordance with the site soil preparation recommendations described for the building area. While specific traffic loads and volumes for the project have not been provided, we are providing recommended light-duty and medium-duty pavement sections, which have been successfully utilized for this type of commercial development in the Northwest Florida area with similar traffic loadings.

Light Duty (Automobile Parking)

- 1 ½ inches Asphalt Concrete (FDOT Superpave Mix SP-12.5 or SP-9.5)
- 6 inches Crushed Limerock or Graded Aggregate Base
- 12 inches stabilized subgrade (minimum LBR 40)

Medium Duty (Entrance Lanes)

- 2 inches Asphaltic Concrete (FDOT Superpave Mix SP-12.5)
- 8 inches Crushed Limerock or Graded Aggregate Base
- 12 inches Stabilized Subgrade (minimum LBR 40)

A rigid pavement section merits consideration for areas to receive relatively high concentrated sustained loads such as dumpsters and loading/storage areas. A rigid concrete pavement of 6 inches in minimum thickness will distribute concentrated loads over a greater area, hence reducing the possibility of high stress concentrations to the subgrade. The concrete used for rigid pavement should have a minimum 28-day flexural strength of 650 psi and a maximum slump of 4 inches. The subgrade should consist of a near uniform soil of equivalent moisture content and density. Pavement joints, reinforcing, and details should be designed in accordance with applicable American Concrete Institute (ACI) standards.

The above recommended pavement sections represent minimum design thicknesses and, as such, periodic maintenance should be anticipated. Also, these recommended pavement sections should be confirmed or modified by your Civil Engineer, based on actual traffic and the owner's requirements. The pavement section materials and construction should comply with the Florida DOT and local municipality requirements.

Double Ring Infiltrometer Test

One (1) Double Ring Infiltrometer test was performed in the field in general accordance with the procedures outlined in ASTM D-3385, "Infiltration Rate of Soils in Field using Double Ring Infiltrometers". Testing consisted of initially clearing all surface vegetation and topsoil from within the test area. The Infiltration test was performed approximately 2.0 feet below existing grade at location DRI-1. The outer ring, which is approximately 24 inches in diameter, was then driven to a depth of 6 inches below the exposed ground surface. The inner ring, approximately 12 inches in diameter, was then centrally located within the outer ring and driven to a depth of 2 inches. The two rings were then simultaneously filled with water to a height of 4 inches above the exposed ground surface test soils. The water level was maintained at this height throughout the test period, with the required amount of water added to maintain this level in both rings recorded at time intervals of 5 minutes.

The infiltration rate for the inner ring and the annular space between the rings is determined by dividing (a) the water volume used (within each specific area) during the stabilized flow period of the test, by (b) the specific area and (c) the time interval. Infiltration rates are generally converted to units of inches per hour. The infiltration rate for the inner ring, if different than the infiltration rate of the annular area between the rings, according to ASTM, should be used as the infiltration rate for the soils.

ENVIRONMENTAL RESOURCE PERMITTING (ERP) DESIGN PARAMETERS

| DESCRIPTION | LOCATION | DESIGN PARAMETER |
|---|----------|-------------------------------|
| SUSTAINED INFILTRATION RATE (K_{vu}) | DRI-1 | 1.1 IN/HR* |
| TEST DEPTH | DRI-1 | 2.0 FT |
| FILLABLE POROSITY | DRI-1 | 25% |
| DEPTH TO EXISTING GROUNDWATER TABLE | DRI-1 | >15.0 FT BELOW EXISTING GRADE |
| DEPTH TO ESTIMATED SEASONAL HIGH GROUNDWATER TABLE | DRI-1 | >15.0 FT BELOW EXISTING GRADE |

*** The above infiltration rate has not been factored and it is up to the designer to apply an appropriate factor of safety.**

We recommend using a transformation ratio of 1 horizontal to 1 vertical (i.e. the estimated ratio of horizontal to vertical permeability).

Warranty and Limitations of Study

Our professional services have been performed, our findings obtained, and our recommendations prepared in accordance with generally accepted geotechnical engineering principles and practices. This warranty is in lieu of all other warranties, either expressed or implied. Magnum Engineering, Inc. is not responsible for the independent conclusions, opinions or recommendations made by others based on the field exploration and laboratory test data presented in this report.

Soil conditions at other locations may differ from those encountered in the test borings, and the passage of time may cause the soils conditions to change from those described in this report.

This report is intended for use by the designers of this project. While we have no objections to it being provided for review by parties to this project, it is not a specification document and is not to be used as a part of the specifications. If desired, we can assist in the development of specifications for this project based upon our exploration.

The nature and extent of variation and change in the subsurface conditions at the site may not become evident until the course of construction. Construction monitoring by the geotechnical engineer or his representative is therefore considered necessary to verify the subsurface conditions and to check that the soils connected construction phases are properly carried out. If significant variations or changes are in evidence, it may be necessary to reevaluate the recommendations in this report.

Furthermore, if the project characteristics are altered significantly from those discussed in this report, if the project information contained in this report is incorrect or if additional information becomes available, a review must be made by this office to determine if any modifications in the recommendations will be necessary.

Glendale Fire Department – Geotechnical Services
Walton County, Florida
Page 7 of 7

We hope this letter provides sufficient information for the present. If you have any questions or comments, please feel free to call.

Sincerely,
MAGNUM ENGINEERING, INC.

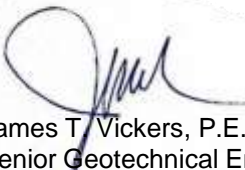
James T. Vickers, P.E.
Senior Geotechnical Engineer
Florida Registration # 56813

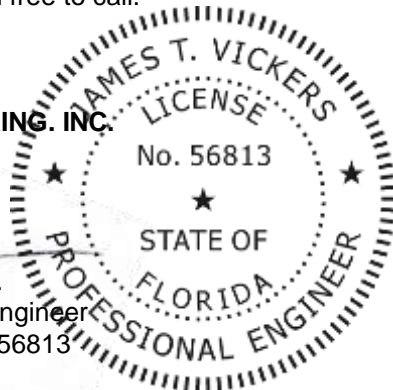

Attachments: Figure #1 – Boring Location Plan
Figure #2 – Logs of Borings
Appendix A – Double Ring Infiltrometer Test Results



MAGNUM ENGINEERING INC
GEOTECHNICAL ENGINEERING CONSULTANTS

BORING LOCATION PLAN

FIGURE # 1



MAGNUM ENGINEERING INC
GEOTECHNICAL ENGINEERING CONSULTANTS

LOGS OF BORINGS

FIGURE # 2



Magnum Engineering, Inc.
 429 Florida Avenue
 Lynn Haven, Florida 32444
 Telephone: 8502658332

BORING NUMBER B-1

CLIENT Dewberry Engineers Inc

PROJECT NAME Glendale Fire Department

PROJECT NUMBER M123-109-195

PROJECT LOCATION Walton County, Florida

DATE STARTED 7/3/23 COMPLETED 7/3/23

GROUND ELEVATION _____ HOLE SIZE _____

DRILLING CONTRACTOR GeoDrill Tech, LLC

GROUND WATER LEVELS:

DRILLING METHOD Standard Penetration Test (SPT)

∇ DEPTH TO GROUNDWATER AT TIME OF DRILLING 17.3 ft

LOGGED BY J. Governale CHECKED BY J. Vickers

ESTIMATED SEASONAL HIGH GWL ---

NOTES _____

AFTER DRILLING ---

| DEPTH (ft) | GRAPHIC LOG | MATERIAL DESCRIPTION | SAMPLE TYPE NUMBER | RECOVERY % (RQD) | BLOW COUNTS (N VALUE) | POCKET PEN. (tsf) | DRY UNIT WT. (pcf) | MOISTURE CONTENT (%) | ATTERBERG LIMITS | | | FINES CONTENT (%) |
|------------|-------------|--|--------------------------------|------------------|-----------------------|-------------------|--------------------|----------------------|------------------|---------------|------------------|-------------------|
| | | | | | | | | | LIQUID LIMIT | PLASTIC LIMIT | PLASTICITY INDEX | |
| 0 | | | | | | | | | | | | |
| | | Brown Clayey Fine SAND (SC) | SS 1 | | 2-3-4-4 (7) | | | | | | | |
| | | | | SS 2 | | 5-7-8-10 (15) | | | | | | |
| 5 | | Tan/Orange Clayey Fine SAND (SC) | SS 3 | | 4-9-11-13 (20) | | | | | | | |
| | | | Gray/Tan Clayey Fine SAND (SC) | SS 4 | | 6-10-13-16 (23) | | | | | | |
| | | | | SS 5 | | 8-11-15-17 (26) | | | | | | |
| 10 | | | | | | | | | | | | |
| | | | | SS 6 | | 10-13-16 (29) | | | | | | |
| 15 | | | | | | | | | | | | |
| | | Tan Slightly Silty Fine SAND (SP-SM) | SS 7 | | 10-12-13 (25) | | | | | | | |
| 20 | | | | | | | | | | | | |
| | | | SS 8 | | 9-10-12 (22) | | | | | | | |
| 25 | | Boring Termination Depth at 25.0 feet. | | | | | | | | | | |

GEOTECH BH COLUMNS GLENDALE FIRE DEPARTMENT.GPJ GINT STD US LAB.GDT 7/25/23



Magnum Engineering, Inc.
 429 Florida Avenue
 Lynn Haven, Florida 32444
 Telephone: 8502658332

BORING NUMBER B-2

| | |
|--|--|
| CLIENT <u>Dewberry Engineers Inc</u> | PROJECT NAME <u>Glendale Fire Department</u> |
| PROJECT NUMBER <u>M123-109-195</u> | PROJECT LOCATION <u>Walton County, Florida</u> |
| DATE STARTED <u>7/3/23</u> COMPLETED <u>7/3/23</u> | GROUND ELEVATION _____ HOLE SIZE _____ |
| DRILLING CONTRACTOR <u>GeoDrill Tech, LLC</u> | GROUND WATER LEVELS: |
| DRILLING METHOD <u>Standard Penetration Test (SPT)</u> | ∇ DEPTH TO GROUNDWATER AT TIME OF DRILLING <u>16.3 ft</u> |
| LOGGED BY <u>J. Governale</u> CHECKED BY <u>J. Vickers</u> | ESTIMATED SEASONAL HIGH GWT <u>---</u> |
| NOTES _____ | AFTER DRILLING <u>---</u> |

| DEPTH (ft) | GRAPHIC LOG | MATERIAL DESCRIPTION | SAMPLE TYPE NUMBER | RECOVERY % (RQD) | BLOW COUNTS (N VALUE) | POCKET PEN. (tsf) | DRY UNIT WT. (pcf) | MOISTURE CONTENT (%) | ATTERBERG LIMITS | | | FINES CONTENT (%) |
|------------|-------------|---|--------------------------------|------------------|-----------------------|-------------------|--------------------|----------------------|------------------|---------------|------------------|-------------------|
| | | | | | | | | | LIQUID LIMIT | PLASTIC LIMIT | PLASTICITY INDEX | |
| 0 | | | | | | | | | | | | |
| | | Brown Clayey Fine SAND (SC) | SS 1 | | 2-2-2-2 (4) | | | | | | | |
| | | | | SS 2 | | 3-3-3-5 (6) | | | | | | |
| 5 | | Orange/Tan Clayey Fine SAND (SC) | SS 3 | | 4-5-9-10 (14) | | | | | | | |
| | | | | SS 4 | | 6-9-12-16 (21) | | | | | | |
| | | | | SS 5 | | 11-12-15-18 (27) | | | | | | |
| 10 | | | Gray/Tan Clayey Fine SAND (SC) | | | | | | | | | |
| | | | | SS 6 | | 12-16-19 (35) | | | | | | |
| 15 | | | | | | | | | | | | |
| | | Tan/Gray Slightly Silty Fine SAND (SP-SM) | SS 7 | | 13-20-24 (44) | | | | | | | |
| 20 | | | | | | | | | | | | |
| | | Tan Slightly Silty Fine SAND (SP-SM) | SS 8 | | 13-19-22 (41) | | | | | | | |
| 25 | | | | | | | | | | | | |
| | | Boring Termination Depth at 25.0 feet. | | | | | | | | | | |

GEOTECH BH COLUMNS GLENDALE FIRE DEPARTMENT.GPJ GINT STD US LAB.GDT 7/25/23



Magnum Engineering, Inc.
 429 Florida Avenue
 Lynn Haven, Florida 32444
 Telephone: 8502658332

BORING NUMBER PA-1

CLIENT Dewberry Engineers Inc

PROJECT NAME Glendale Fire Department

PROJECT NUMBER M123-109-195

PROJECT LOCATION Walton County, Florida

DATE STARTED 7/3/23 COMPLETED 7/3/23

GROUND ELEVATION _____ HOLE SIZE _____

DRILLING CONTRACTOR GeoDrill Tech, LLC

GROUND WATER LEVELS:

DRILLING METHOD Power Auger Boring

DEPTH TO GROUNDWATER AT TIME OF DRILLING ---

LOGGED BY J. Governale CHECKED BY J. Vickers

ESTIMATED SEASONAL HIGH GWAT ---

NOTES _____

AFTER DRILLING ---

| DEPTH (ft) | GRAPHIC LOG | MATERIAL DESCRIPTION | SAMPLE TYPE NUMBER | RECOVERY % (RQD) | BLOW COUNTS (N VALUE) | POCKET PEN. (tsf) | DRY UNIT WT. (pcf) | MOISTURE CONTENT (%) | ATTERBERG LIMITS | | | FINES CONTENT (%) | |
|------------|-------------|--|--------------------|------------------|-----------------------|-------------------|--------------------|----------------------|------------------|---------------|------------------|-------------------|----|
| | | | | | | | | | LIQUID LIMIT | PLASTIC LIMIT | PLASTICITY INDEX | | |
| 0.0 | | Brown Clayey Fine SAND (SC) | | | | | | | | | | | |
| 2.5 | | Orange Clayey Fine SAND (SC) | | | | | | | | | | | AU |
| 5.0 | | | | | | | | | | | | | |
| 7.5 | | | | | | | | | | | | | |
| 10.0 | | Brown/Gray Clayey Fine SAND (SC) | | | | | | | | | | | |
| 12.5 | | | | | | | | | | | | | |
| 15.0 | | Boring Termination Depth at 15.0 feet. | | | | | | | | | | | |

GEOTECH BH COLUMNS GLENDALE FIRE DEPARTMENT.GPJ GINT STD US LAB.GDT 7/25/23



Magnum Engineering, Inc.
 429 Florida Avenue
 Lynn Haven, Florida 32444
 Telephone: 8502658332

BORING NUMBER PA-2

CLIENT Dewberry Engineers Inc

PROJECT NAME Glendale Fire Department

PROJECT NUMBER M123-109-195

PROJECT LOCATION Walton County, Florida

DATE STARTED 7/3/23 COMPLETED 7/3/23

GROUND ELEVATION _____ HOLE SIZE _____

DRILLING CONTRACTOR GeoDrill Tech, LLC

GROUND WATER LEVELS:

DRILLING METHOD Power Auger Boring

DEPTH TO GROUNDWATER AT TIME OF DRILLING ---

LOGGED BY J. Governale CHECKED BY J. Vickers

ESTIMATED SEASONAL HIGH GWL ---

NOTES _____

AFTER DRILLING ---

| DEPTH (ft) | GRAPHIC LOG | MATERIAL DESCRIPTION | SAMPLE TYPE NUMBER | RECOVERY % (RQD) | BLOW COUNTS (N VALUE) | POCKET PEN. (tsf) | DRY UNIT WT. (pcf) | MOISTURE CONTENT (%) | ATTERBERG LIMITS | | | FINES CONTENT (%) |
|------------|-------------|--|--------------------|------------------|-----------------------|-------------------|--------------------|----------------------|------------------|---------------|------------------|-------------------|
| | | | | | | | | | LIQUID LIMIT | PLASTIC LIMIT | PLASTICITY INDEX | |
| 0.0 | | Brown Clayey Fine SAND (SC) | AU | | | | | | | | | |
| 2.5 | | | | | | | | | | | | |
| 5.0 | | Orange Clayey Fine SAND (SC) | | | | | | | | | | |
| 7.5 | | | | | | | | | | | | |
| 10.0 | | Boring Termination Depth at 15.0 feet. | | | | | | | | | | |
| 12.5 | | | | | | | | | | | | |
| 15.0 | | | | | | | | | | | | |

GEOTECH BH COLUMNS GLENDALE FIRE DEPARTMENT.GPJ GINT STD US LAB.GDT 7/25/23



Magnum Engineering, Inc.
 429 Florida Avenue
 Lynn Haven, Florida 32444
 Telephone: 8502658332

BORING NUMBER PA-3

CLIENT Dewberry Engineers Inc
 PROJECT NUMBER M123-109-195
 DATE STARTED 7/3/23 COMPLETED 7/3/23
 DRILLING CONTRACTOR GeoDrill Tech, LLC
 DRILLING METHOD Power Auger Boring
 LOGGED BY J. Governale CHECKED BY J. Vickers
 NOTES _____

PROJECT NAME Glendale Fire Department
 PROJECT LOCATION Walton County, Florida
 GROUND ELEVATION _____ HOLE SIZE _____
 GROUND WATER LEVELS:
 DEPTH TO GROUNDWATER AT TIME OF DRILLING ---
 ESTIMATED SEASONAL HIGH GWAT ---
 AFTER DRILLING ---

| DEPTH (ft) | GRAPHIC LOG | MATERIAL DESCRIPTION | SAMPLE TYPE NUMBER | RECOVERY % (RQD) | BLOW COUNTS (N VALUE) | POCKET PEN. (tsf) | DRY UNIT WT. (pcf) | MOISTURE CONTENT (%) | ATTERBERG LIMITS | | | FINES CONTENT (%) |
|------------|-------------|--|--------------------|------------------|-----------------------|-------------------|--------------------|----------------------|------------------|---------------|------------------|-------------------|
| | | | | | | | | | LIQUID LIMIT | PLASTIC LIMIT | PLASTICITY INDEX | |
| 0.0 | | Orange Clayey Fine SAND (SC) | AU | | | | | | | | | |
| 2.5 | | Brown/Orange Clayey Fine SAND (SC) | | | | | | | | | | |
| 5.0 | | | | | | | | | | | | |
| 7.5 | | | | | | | | | | | | |
| 10.0 | | Boring Termination Depth at 15.0 feet. | | | | | | | | | | |
| 12.5 | | | | | | | | | | | | |
| 15.0 | | | | | | | | | | | | |

GEOTECH BH COLUMNS GLENDALE FIRE DEPARTMENT.GPJ GINT STD US LAB.GDT 7/25/23



Magnum Engineering, Inc.
 429 Florida Avenue
 Lynn Haven, Florida 32444
 Telephone: 8502658332

BORING NUMBER PA-4

CLIENT Dewberry Engineers Inc

PROJECT NAME Glendale Fire Department

PROJECT NUMBER M123-109-195

PROJECT LOCATION Walton County, Florida

DATE STARTED 7/3/23 COMPLETED 7/3/23

GROUND ELEVATION _____ HOLE SIZE _____

DRILLING CONTRACTOR GeoDrill Tech, LLC

GROUND WATER LEVELS:

DRILLING METHOD Power Auger Boring

DEPTH TO GROUNDWATER AT TIME OF DRILLING ---

LOGGED BY J. Governale CHECKED BY J. Vickers

ESTIMATED SEASONAL HIGH GWAT ---

NOTES _____

AFTER DRILLING ---

| DEPTH (ft) | GRAPHIC LOG | MATERIAL DESCRIPTION | SAMPLE TYPE NUMBER | RECOVERY % (RQD) | BLOW COUNTS (N VALUE) | POCKET PEN. (tsf) | DRY UNIT WT. (pcf) | MOISTURE CONTENT (%) | ATTERBERG LIMITS | | | FINES CONTENT (%) |
|------------|-------------|--|--------------------|------------------|-----------------------|-------------------|--------------------|----------------------|------------------|---------------|------------------|-------------------|
| | | | | | | | | | LIQUID LIMIT | PLASTIC LIMIT | PLASTICITY INDEX | |
| 0.0 | | Tan Clayey Fine SAND (SC) | | | | | | | | | | |
| 2.5 | | | | | | | | | | | | |
| 5.0 | | | | | | | | | | | | |
| 7.5 | | Gray/Tan Clayey Fine SAND (SC) | | | | | | | | | | |
| 10.0 | | | | | | | | | | | | |
| 12.5 | | | | | | | | | | | | |
| 15.0 | | | | | | | | | | | | |
| | | Boring Termination Depth at 15.0 feet. | | | | | | | | | | |

GEOTECH BH COLUMNS GLENDALE FIRE DEPARTMENT.GPJ GINT STD US LAB.GDT 7/25/23



MAGNUM ENGINEERING INC
GEOTECHNICAL ENGINEERING CONSULTANTS

DOUBLE RING INFILTRMETER TEST
RESULTS

APPENDIX A



MAGNUM ENGINEERING INC
 GEOTECHNICAL ENGINEERING CONSULTANTS

Double-Ring Field Infiltration Test

Test Location: DRI-1
Project Name: Glendale Fire Department
Project Location: Walton County
Test Depth: 2.0 ft
 Depth to GWT: >15 ft
 Inner Ring Diameter: 12 in 0.3048 m
 Outer Ring Diameter: 24 in 0.6096 m
 Pre-Saturation: 30 min
 Area Outer Ring: 3.1416 ft² 0.00202683 m²
 Area Inner Ring: 0.7854 ft² 0.00050671 m²
 Net Outer Ring Area: 2.3562 ft² 0.00152013 m²

| Inner Ring | | | |
|------------|----------------|-----------------------------|----------------------------|
| Cycle | ElapTime (sec) | Vol Used (in ³) | Infiltration Rate (ft/sec) |
| 1 | 300 | 14 | 3.44E-05 |
| 2 | 300 | 14 | 3.44E-05 |
| 3 | 300 | 14 | 3.44E-05 |
| 4 | 300 | 12 | 2.95E-05 |
| 5 | 300 | 10 | 2.46E-05 |
| 6 | 300 | 10 | 2.46E-05 |
| 7 | 300 | 10 | 2.46E-05 |
| 8 | 300 | 10 | 2.46E-05 |
| 9 | 300 | 10 | 2.46E-05 |
| 10 | 300 | 10 | 2.46E-05 |
| 11 | 300 | 10 | 2.46E-05 |
| 12 | 300 | 10 | 2.46E-05 |
| 13 | 300 | 10 | 2.46E-05 |
| 14 | 300 | 10 | 2.46E-05 |
| 15 | 300 | 10 | 2.46E-05 |
| 16 | 300 | 10 | 2.46E-05 |
| 17 | 300 | 10 | 2.46E-05 |
| 18 | 300 | 10 | 2.46E-05 |
| Results | Sustained Rate | 11 | 2.65E-05 |

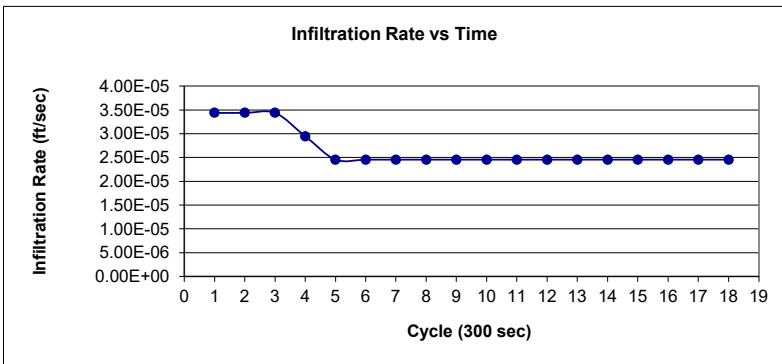

Infiltration Rate: 7.49E-04 cm/sec
 1.1 in/hr

APPENDIX C
Roof Panel Installation Guide



PBR-Panel

Metal Roof and Wall Panel

Installation Manual

The application and detail drawings in this manual are strictly for illustration purposes and may not be applicable to all building designs or product installations. All projects should conform to applicable building codes for that particular area. It is recommended to follow all building regulations and standard industry practices.

Metal Sales Manufacturing Corporation is not responsible for the performance of the roof system if it is not installed in accordance with the suggested instructions referenced in this manual. If there is a conflict between this manual and the approved Metal Sales' erection drawings, the approved erection drawings are to take precedence.

Prior to ordering and installing materials, all dimensions should be verified by field measurements.

Oil canning is not a cause for rejection. Oil canning can be described as the amount of waviness found in the flat areas of metal panels. Oil canning is an inherent characteristic of light gauge cold formed metal products, particularly those with broad flat areas. There are many factors which may contribute to oil canning that Metal Sales is not able to control. These factors include: misalignment of the support system, over driving of fasteners used on the panels, stress (whether inherent in the panel or induced), thermal expansion and contraction of the panel, material handling, width, gauge, length, color of panels, and installation. (Reference Metal Construction Association "Oil Canning Position Paper" - Appendix A).

Metal Sales reserves the right to modify, without notice, any details, recommendations or suggestions. Any questions you may have regarding proper installation of the Magna-Loc roofing system should be directed to your Metal Sales representative, (see pages 2 and 3).

Consult Metal Sales for any additional information not outlined in this manual.

This manual is designed to be utilized as a guide when installing Magna-Loc roofing system. It is the responsibility of the erector to ensure the safe installation of this product system.

SAFETY

STUDY APPLICABLE OSHA AND OTHER SAFETY REQUIREMENTS BEFORE FOLLOWING THESE INSTRUCTIONS.

The installation of metal roof systems is a dangerous procedure and should be supervised by trained knowledgeable erectors. **USE EXTREME CARE WHILE INSTALLING ROOF PANELS.** It is not possible for Metal Sales to be aware of all the possible job site situations that could cause an unsafe condition to exist. The erector of the roof system is responsible for reading these instructions and determining the safest way to install the roof system.

These instructions are provided only as a guide to show a knowledgeable, trained erector the correct parts placement one to another. If following any of the installation steps would endanger a worker, the erector should stop work and decide upon a corrective action.

Provide required safety railing, netting, or safety lines for crew members working on the roof.

Do not use the roof panel as a walking platform. The roof panels will not withstand the weight of a person standing at the edge of the panel.

Do not stand on any part of a roof panel until the panel has been completely attached.

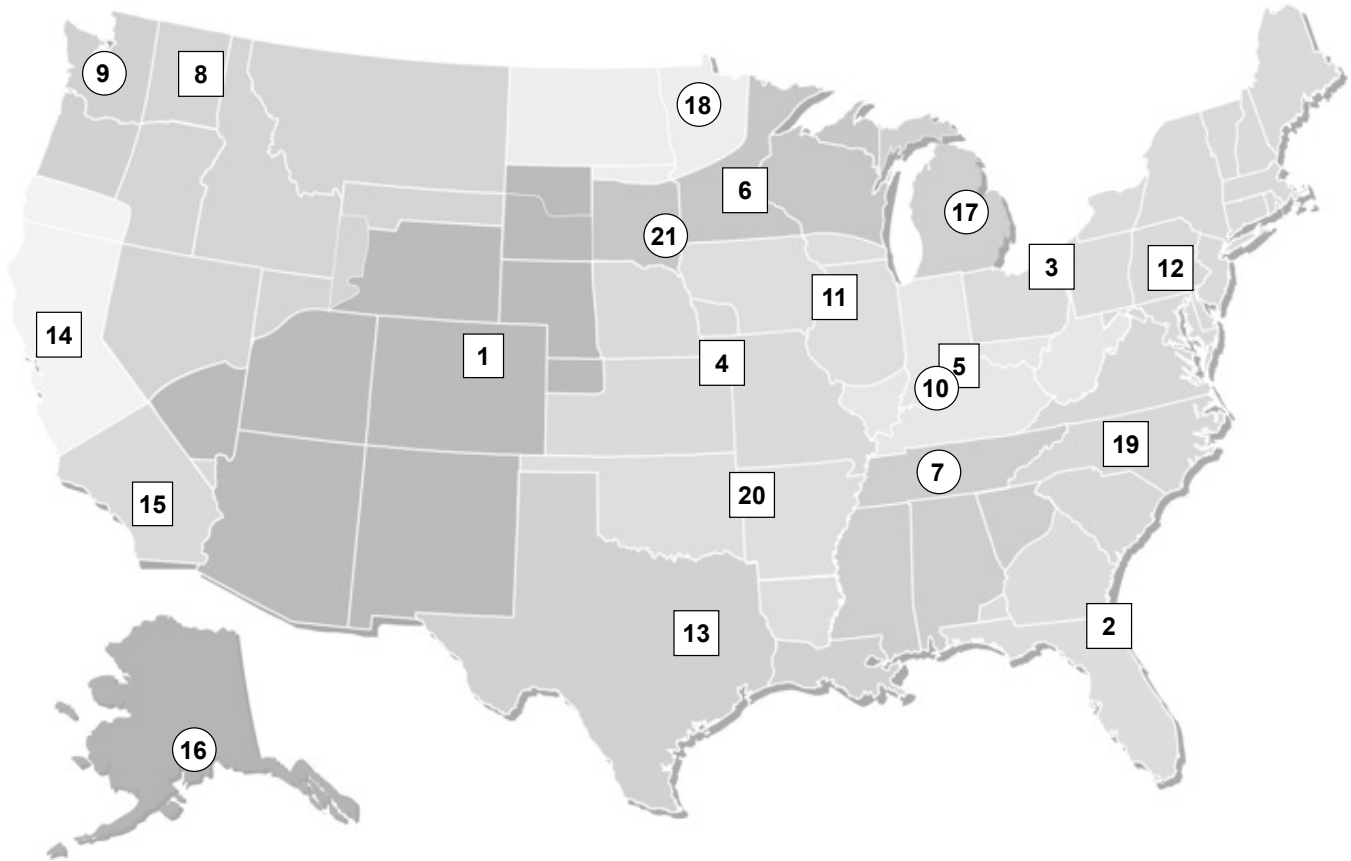

NOTE: Shaded areas represent regions served by each location.

Branches that manufacture PBR-Panel and/or R-Panel

Metal Sales offers a complete line of metal roof, wall, and fascia panel systems for the commercial, architectural, industrial, residential, and agricultural markets. Metal Sales offers over 75 profiles with a wide selection of widths, colors, and gauges - new construction or retrofit.

1.) DENVER BRANCH

7990 E. I-25 Frontage Road
Longmont, CO 80504
303.702.5440 Phone
800.289.7663 Toll Free
800.289.1617 Toll Free Fax

2.) JACKSONVILLE BRANCH

7110 Stuart Avenue
Jacksonville, FL 32254
904.783.3660 Phone
800.394.4419 Toll Free
904.783.9175 Fax
800.413.3292 Toll Free Fax

3.) JEFFERSON BRANCH

352 East Erie Street
Jefferson, OH 44047
440.576.9070 Phone
800.321.5833 Toll Free
440.576.9242 Fax
800.233.5719 Toll Free Fax

4.) INDEPENDENCE BRANCH

1306 S. Powell Road
Independence, MO 64057
816.796.0900 Phone
800.747.0012 Toll Free
816.796.0906 Fax

5.) SELLERSBURG BRANCH

7800 State Road 60
Sellersburg, IN 47172
812.246.1866 Phone
800.999.7777 Toll Free
812.246.0893 Fax
800.477.9318 Toll Free Fax

6.) ROGERS BRANCH

22651 Industrial Blvd.
Rogers, MN 55374
763.428.8080 Phone
800.328.9316 Toll Free
763.428.8525 Fax
800.938.9119 Toll Free Fax

7.) NASHVILLE BRANCH

4314 Hurricane Creek Blvd.
Antioch, TN 37013
615.641.7100 Phone
800.251.8508 Toll Free
615.641.7118 Fax
800.419.4372 Toll Free Fax

8.) SPOKANE BRANCH

East 2727 Trent Avenue
Spokane, WA 99202
509.536.6000 Phone
800.572.6565 Toll Free
509.534.4427 Fax

9.) SEATTLE BRANCH

20213 84th Avenue, South
Kent, WA 98032
253.872.5750 Phone
800.431.3470 Toll Free (Outside WA)
800.742.7900 Toll Free (Inside WA)
253.872.2008 Fax

11.) ROCK ISLAND BRANCH

8111 West 29th Street
Rock Island, IL 61201
309.787.1200 Phone
800.747.1206 Toll Free
309.787.1833 Fax

12.) DEER LAKE BRANCH

29 Pinedale Industrial Road
Orwigsburg, PA 17961
570.366.2020 Phone
800.544.2577 Toll Free
570.366.1648 Fax
800.544.2574 Toll Free Fax

13.) TEMPLE BRANCH

3838 North General Bruce Dr.
Temple, TX 76501
254.791.6650 Phone
800.543.4415 Toll Free
254.791.6655 Fax
800.543.4473 Toll Free Fax

14.) WOODLAND BRANCH

1326 Paddock Place
Woodland, CA 95776
530.668.5690 Phone
800.759.6019 Toll Free
530.668.0901 Fax

15.) FONTANA BRANCH

14213 Whittram Avenue
Fontana, CA 92335
909.829.8618 Phone
800.782.7953 Toll Free
909.829.9083 Fax

16.) ANCHORAGE BRANCH

4637 Old Seward Hwy.
Anchorage, AK 99503
907.646.7663 Phone
866.640.7663 Toll Free
907.646.7664 Fax

17.) BAY CITY BRANCH

5209 Mackinaw Road
Bay City, MI 48706
989.686.5879 Phone
888.777.7640 Toll Free
989.686.5870 Fax
888.777.0112 Toll Free Fax

18.) DETROIT LAKES BRANCH

1435 Egret Avenue
Detroit Lakes, MN 56501
218.847.2988 Phone
888.594.1394 Toll Free
218.847.4835 Fax
888.594.1454 Toll Free Fax

19.) MOCKSVILLE BRANCH

188 Quality Drive
Mocksville, NC 27028
336.751.6381 Phone
800.228.6119 Toll Free
336.751.6301 Fax
800.228.7916 Toll Free Fax

20.) FORT SMITH BRANCH

7510 Ball Road
Fort Smith, AR 72908
479.646.1176 Phone
877.452.3915 Toll Free
479.646.5204 Fax

21.) SIOUX FALLS BRANCH

2700 West 3rd Street, Suite 4
Sioux Falls, SD 57104
605.335.2745 Phone
888.297.0024 Toll Free

TECHNICAL SUPPORT**TECHNICAL SERVICES**

545 South 3rd Street
Louisville, KY 40202
502.855.4300 Phone
800.406.7387 Toll Free
502.855.4290 Fax
800.944.6884 Toll Free Fax

PBR-PANEL

PANEL OVERVIEW

PBR-PANEL PROFILE

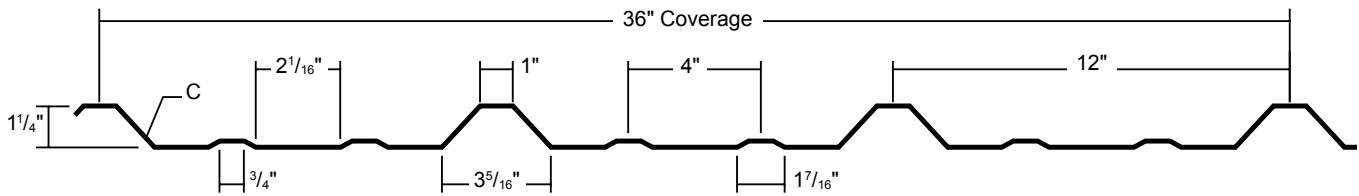

R-PANEL PROFILE

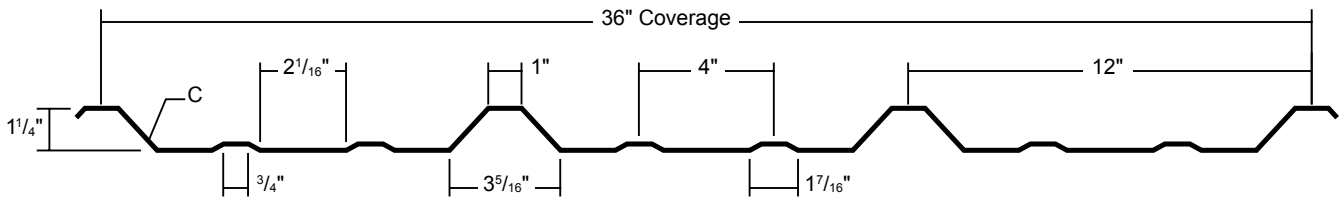

SLOPE

The minimum recommended slope for any "R" and "PBR"-Panel is 1:12. Metal Sales recommends that in all roof applications sealant be used on sidelaps.

SUBSTRATE

R-Panel is designed to be utilized over open structural framing, but can easily be used with a solid substrate. The recommended substrate is 5/8" plywood with a 30 pound felt moisture barrier. To avoid panel distortion, use a properly aligned and uniform substructure. **PBR-Panel is recommended for roof applications.**

COVERAGE

Each panel has a coverage of 36".

LENGTH

Lengths under 5'-0" are available with some cutting restrictions. Maximum recommended panel length is 45'-0". Longer panels require additional consideration in packaging, shipping, and erection. Please consult your Metal Sales branch for recommendations.

AVAILABILITY

Panels are available in 26, 24, and 22 gauge. Minimum quantities may apply.

APPLICATION

Commercial, Industrial, and Architectural panels.

PERFORMANCE TEST

UL 580, UL 2218, UL 790, Texas Department of Insurance, Cantilever Diaphragm.

FASTENING SYSTEM

Direct Fastened (exposed).

FASTENERS

The fastener selection guide should be consulted for choosing proper fasteners for specific applications. Quantity and type of fastener must meet necessary loading and code requirements (see PGI-12-14).

MATERIALS

Steel grade 50 per ASTM A-792
Steel grade 80 per ASTM A-792 or ASTM A-653

FINISH

- ▶ Acrylic Coated Galvalume® (ACG) / ASTM A-792 - AZ55
- ▶ Pre-painted Galvalume / ASTM A-792 - AZ50
- ▶ MS Colorfast45®
- ▶ PVDF (Kynar 500)

* Differential appearance of Acrylic Coated Galvalume roofing materials is not a cause for rejection.

** Meets both Kynar 500 and Hylar 5000 specifications.

PBR-PANEL

PANEL OVERVIEW

PBR-PANEL PROFILE

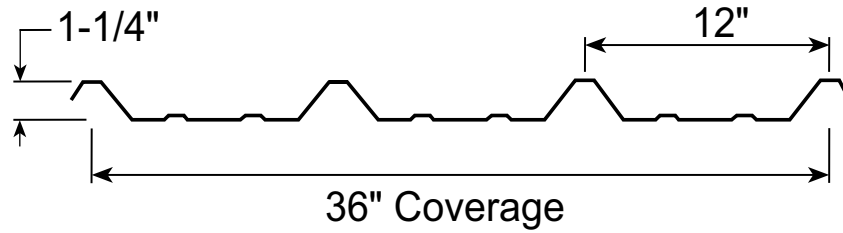

| FINISH | GAUGE | COVERAGE | PRODUCT NO. | WT/SQ |
|--------|-------|----------|-------------|-------|
|--------|-------|----------|-------------|-------|

| | | | | |
|-----------------|----|-----|---------|-----|
| ACG | 26 | 36" | 2505241 | 83 |
| MS Colorfast45® | 26 | 36" | 25052__ | 83 |
| PVDF Standard♦ | 26 | 36" | 26052__ | 83 |
| ACG | 24 | 36" | 2505241 | 106 |
| PVDF Standard♦ | 24 | 36" | 26052__ | 106 |

♦ See Metal Sales color charts for color selection. __ Represents color code

*Additional lead time required.

R-PANEL PROFILE

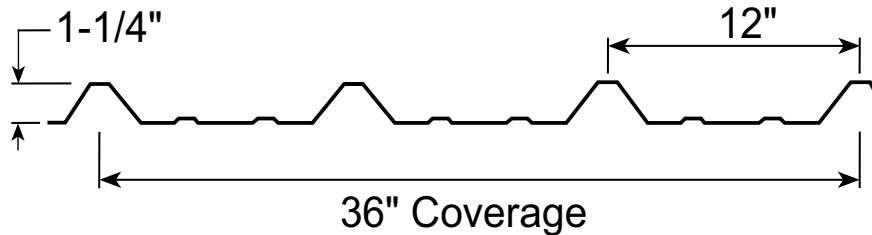

| FINISH | GAUGE | COVERAGE | PRODUCT NO. | WT/SQ |
|--------|-------|----------|-------------|-------|
|--------|-------|----------|-------------|-------|

| | | | | |
|-----------------|----|-----|---------|-----|
| ACG | 26 | 36" | 2505241 | 83 |
| MS Colorfast45® | 26 | 36" | 25052__ | 83 |
| PVDF Standard♦ | 26 | 36" | 26052__ | 83 |
| ACG | 24 | 36" | 2505241 | 106 |
| PVDF Standard♦ | 24 | 36" | 26052__ | 106 |

♦ See Metal Sales color charts for color selection. __ Represents color code

*Additional lead time required.

PANEL NOTES

1. For panel lengths over 45'-0", please inquire.
2. Panels may be installed over structural framing or solid substrate.
3. Minimum recommended roof slope: 1:12. Sidelap sealant and stitch screws required on less than 3:12 slope.
4. Finishes:
 - MS Colorfast45®
 - PVDF (Kynar 500)

PBR-PANEL

FLASHING PROFILES

20" RIDGE/HIP COVER

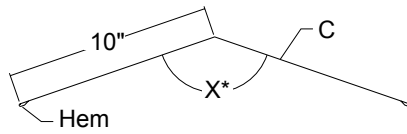

* See chart on page GI-8

| GAUGE | FINISH | PRODUCT NO. | WEIGHT | LENGTH |
|-------|-----------------|-------------|-----------|--------|
| 26 | ACG | 5500641 | 13.90 lbs | 10'-2" |
| 26 | ACG | 5500841 | 27.80 lbs | 20'-3" |
| 26 | MS Colorfast45® | 55006__ | 13.90 lbs | 10'-2" |
| 26 | MS Colorfast45® | 55008__ | 27.80 lbs | 20'-3" |
| 26 | PVDF | 56006__ | 13.90 lbs | 10'-2" |
| 26 | PVDF | 56008__ | 27.80 lbs | 20'-3" |
| 24 | ACG | 5700641 | 15.90 lbs | 10'-2" |
| 24 | ACG | 5700841 | 31.80 lbs | 20'-3" |
| 24 | PVDF | 58006__ | 15.90 lbs | 10'-2" |
| 24 | PVDF | 58008__ | 31.80 lbs | 20'-3" |

UNIVERSAL RIDGE COVER

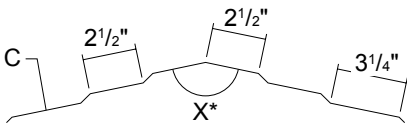

* See chart on page XX

| GAUGE | FINISH | PRODUCT NO. | WEIGHT | LENGTH |
|-------|-----------------|-------------|-----------|--------|
| 26 | ACG | 5501041 | 13.90 lbs | 10'-2" |
| 26 | MS Colorfast45® | 55010__ | 13.90 lbs | 10'-2" |
| 26 | PVDF | 56010__ | 13.90 lbs | 10'-2" |
| 24 | ACG | 5701041 | 15.90 lbs | 10'-2" |
| 24 | PVDF | 58010__ | 15.90 lbs | 10'-2" |

PBR-PANEL FORMED RIDGE

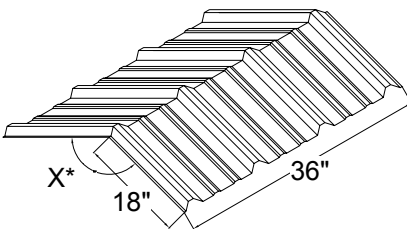

* See chart on page GI-8, Angle same as Ridge/Hip Cover.
 **4:12 Maximum slope on all Formed Ridge
 (Please inquire on minimum quantities required)

| GAUGE | FINISH | PRODUCT NO. | WEIGHT | LENGTH |
|-------|-----------------|-------------|-----------|--------|
| 26 | ACG | 5592141 | 9.00 lbs | 18" |
| 26 | MS Colorfast45® | 55921__ | 9.00 lbs | 18" |
| 26 | PVDF | 56921__ | 9.00 lbs | 18" |
| 24 | ACG | 5672141 | 10.10 lbs | 18" |
| 24 | PVDF | 56722__ | 10.10 lbs | 18" |

VALLEY

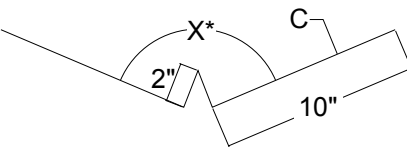

| GAUGE | FINISH | PRODUCT NO. | WEIGHT | LENGTH |
|-------|-----------------|-------------|-----------|--------|
| 26 | ACG | 5301841 | 13.90 lbs | 10'-2" |
| 26 | ACG | 5502041 | 27.80 lbs | 20'-3" |
| 26 | MS Colorfast45® | 53018__ | 13.90 lbs | 10'-2" |
| 26 | MS Colorfast45® | 55020__ | 27.80 lbs | 20'-3" |
| 26 | PVDF | 54018__ | 13.90 lbs | 10'-2" |
| 26 | PVDF | 56020__ | 27.80 lbs | 20'-3" |
| 24 | ACG | 5701841 | 16.85 lbs | 10'-2" |
| 24 | ACG | 5702041 | 33.70 lbs | 20'-3" |
| 24 | PVDF | 58018__ | 16.85 lbs | 10'-2" |
| 24 | PVDF | 58020__ | 33.70 lbs | 20'-3" |

EAVE

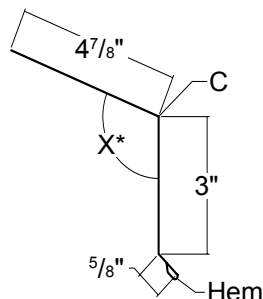

| GAUGE | FINISH | PRODUCT NO. | WEIGHT | LENGTH |
|-------|-----------------|-------------|----------|--------|
| 26 | ACG | 5506941 | 6.00 lbs | 10'-2" |
| 26 | MS Colorfast45® | 55069__ | 6.00 lbs | 10'-2" |
| 26 | PVDF | 56069__ | 6.00 lbs | 10'-2" |
| 24 | ACG | 5706941 | 7.00 lbs | 10'-2" |
| 24 | PVDF | 58069__ | 7.00 lbs | 10'-2" |

PBR-PANEL

FLASHING PROFILES

BOX GUTTER

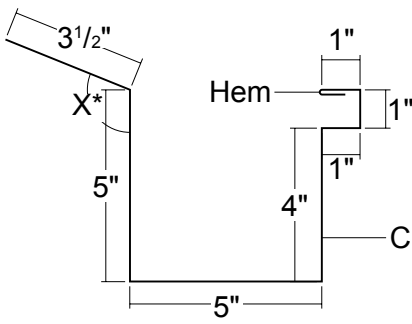

| GAUGE | FINISH | PRODUCT NO. | WEIGHT | LENGTH |
|-------|-----------------|-------------|-----------|--------|
| 26 | ACG | 5507741 | 14.00 lbs | 10'-2" |
| 26 | ACG | 5507941 | 28.00 lbs | 20'-3" |
| 26 | MS Colorfast45® | 55077__ | 14.00 lbs | 10'-2" |
| 26 | MS Colorfast45® | 55079__ | 28.00 lbs | 20'-3" |
| 26 | PVDF | 56077__ | 14.00 lbs | 10'-2" |
| 26 | PVDF | 56079__ | 28.00 lbs | 20'-3" |
| 24 | ACG | 5707741 | 16.95 lbs | 10'-2" |
| 24 | ACG | 5707941 | 33.90 lbs | 20'-3" |
| 24 | PVDF | 58077__ | 16.95 lbs | 10'-2" |
| 24 | PVDF | 58079__ | 33.90 lbs | 20'-3" |

BOX GUTTER END CAP

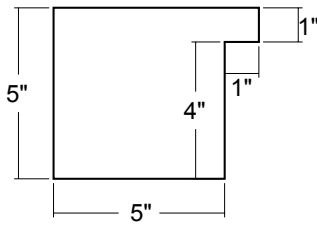

| GAUGE | FINISH | PRODUCT NO. | WEIGHT | SIDE |
|-------|-----------------|-------------|---------|-------|
| 26 | ACG | 5508141 | .20 lbs | Left |
| 26 | ACG | 5508241 | .20 lbs | Right |
| 26 | MS Colorfast45® | 55081__ | .20 lbs | Left |
| 26 | MS Colorfast45® | 55082__ | .20 lbs | Right |
| 26 | PVDF | 56081__ | .20 lbs | Left |
| 26 | PVDF | 56082__ | .20 lbs | Right |
| 24 | ACG | 5708141 | .24 lbs | Left |
| 24 | ACG | 5708241 | .24 lbs | Right |
| 24 | PVDF | 58081__ | .24 lbs | Left |
| 24 | PVDF | 58082__ | .24 lbs | Right |

SCULPTURED GUTTER

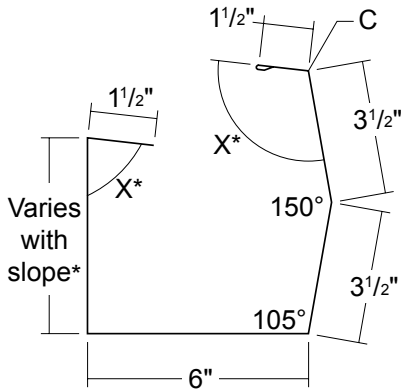

| GAUGE | FINISH | PRODUCT NO. | WEIGHT | LENGTH |
|-------|-----------------|-------------|-----------|--------|
| 26 | ACG | 5508441 | 14.00 lbs | 10'-2" |
| 26 | ACG | 5508641 | 28.00 lbs | 20'-3" |
| 26 | MS Colorfast45® | 55084__ | 14.00 lbs | 10'-2" |
| 26 | MS Colorfast45® | 55086__ | 28.00 lbs | 20'-3" |
| 26 | PVDF | 56084__ | 14.00 lbs | 10'-2" |
| 26 | PVDF | 56086__ | 28.00 lbs | 20'-3" |
| 24 | ACG | 5708441 | 16.95 lbs | 10'-2" |
| 24 | ACG | 5708641 | 33.90 lbs | 20'-3" |
| 24 | PVDF | 58084__ | 16.95 lbs | 10'-2" |
| 24 | PVDF | 58086__ | 33.90 lbs | 20'-3" |

SCULPTURED GUTTER END CAP

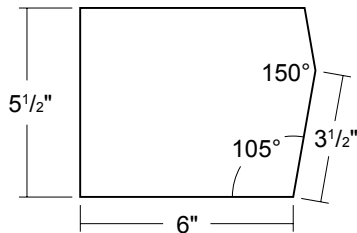

| GAUGE | FINISH | PRODUCT NO. | WEIGHT | SIDE |
|-------|-----------------|-------------|---------|-------|
| 26 | ACG | 5508841 | .20 lbs | Left |
| 26 | ACG | 5508941 | .20 lbs | Right |
| 26 | MS Colorfast45® | 55088__ | .20 lbs | Left |
| 26 | MS Colorfast45® | 55089__ | .20 lbs | Right |
| 26 | PVDF | 56088__ | .20 lbs | Left |
| 26 | PVDF | 56089__ | .20 lbs | Right |
| 24 | ACG | 5708841 | .24 lbs | Left |
| 24 | ACG | 5708941 | .24 lbs | Right |
| 24 | PVDF | 58088__ | .24 lbs | Left |
| 24 | PVDF | 58089__ | .24 lbs | Right |

PBR-PANEL

FLASHING PROFILES

BOX GUTTER/DOWNSPOUT STRAP

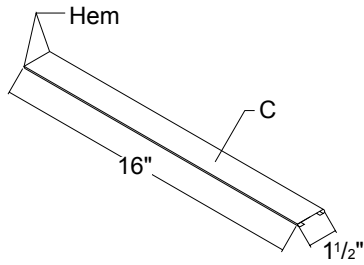

| GAUGE | FINISH | PRODUCT NO. | WEIGHT | LENGTH |
|-------|-----------------|-------------|---------|--------|
| 26 | ACG | 5509241 | .32 lbs | 1'-4" |
| 26 | MS Colorfast45® | 55092__ | .32 lbs | 1'-4" |
| 26 | PVDF | 56092__ | .32 lbs | 1'-4" |
| 24 | ACG | 5709241 | .36 lbs | 1'-4" |
| 24 | PVDF | 58092__ | .36 lbs | 1'-4" |

GUTTER HANGAR

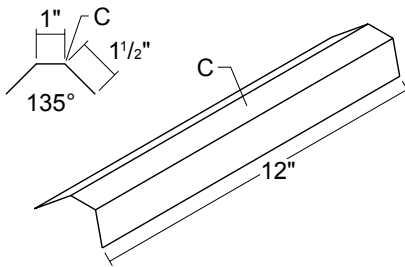

| GAUGE | FINISH | PRODUCT NO. | WEIGHT | LENGTH |
|-------|-----------------|-------------|---------|--------|
| 26 | ACG | 5509141 | .32 lbs | 1'-0" |
| 26 | MS Colorfast45® | 55091__ | .32 lbs | 1'-0" |
| 26 | PVDF | 56091__ | .32 lbs | 1'-0" |
| 24 | ACG | 5709141 | .41 lbs | 1'-0" |
| 24 | PVDF | 58091__ | .41 lbs | 1'-0" |

4" X 3-1/2" DOWNSPOUT

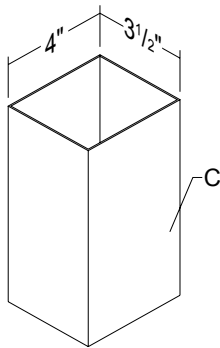

| GAUGE | FINISH | PRODUCT NO. | WEIGHT | LENGTH |
|-------|-----------------|-------------|-----------|--------|
| 26 | ACG | 5509441 | 13.90 lbs | 10'-2" |
| 26 | ACG | 5509741 | 27.80 lbs | 20'-3" |
| 26 | MS Colorfast45® | 55094__ | 13.90 lbs | 10'-2" |
| 26 | MS Colorfast45® | 55097__ | 27.80 lbs | 20'-3" |
| 26 | PVDF | 56094__ | 13.90 lbs | 10'-2" |
| 26 | PVDF | 56097__ | 27.80 lbs | 20'-3" |
| 24 | ACG | 5709441 | 16.85 lbs | 10'-2" |
| 24 | ACG | 5709741 | 33.70 lbs | 20'-3" |
| 24 | PVDF | 58094__ | 16.85 lbs | 10'-2" |
| 24 | PVDF | 58097__ | 33.70 lbs | 20'-3" |

6" X 4" DOWNSPOUT

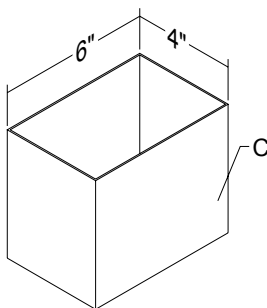

| GAUGE | FINISH | PRODUCT NO. | WEIGHT | LENGTH |
|-------|-----------------|-------------|-----------|--------|
| 26 | ACG | 5509841 | 13.90 lbs | 10'-2" |
| 26 | ACG | 5510141 | 27.80 lbs | 20'-3" |
| 26 | MS Colorfast45® | 55098__ | 13.90 lbs | 10'-2" |
| 26 | MS Colorfast45® | 55101__ | 27.80 lbs | 20'-3" |
| 26 | PVDF | 56098__ | 13.90 lbs | 10'-2" |
| 26 | PVDF | 56101__ | 27.80 lbs | 20'-3" |
| 24 | ACG | 5709841 | 16.85 lbs | 10'-2" |
| 24 | ACG | 5710141 | 33.70 lbs | 20'-3" |
| 24 | PVDF | 58098__ | 16.85 lbs | 10'-2" |
| 24 | PVDF | 58101__ | 33.70 lbs | 20'-3" |

PBR-PANEL

FLASHING PROFILES

4" DOWNSPOUT STRAP

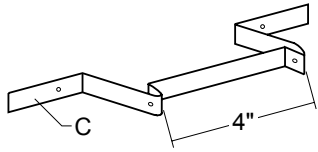

| GAUGE | FINISH | PRODUCT NO. | WEIGHT |
|-------|-----------------|-------------|---------|
| 26 | ACG | 5511041 | .32 lbs |
| 26 | MS Colorfast45® | 55110__ | .32 lbs |
| 26 | PVDF | 56110__ | .32 lbs |
| 24 | ACG | 5711041 | .36 lbs |
| 24 | PVDF | 58110__ | .36 lbs |

6" DOWNSPOUT STRAP

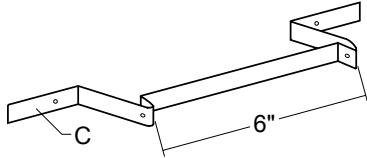

| GAUGE | FINISH | PRODUCT NO. | WEIGHT |
|-------|-----------------|-------------|---------|
| 26 | ACG | 5511241 | .32 lbs |
| 26 | MS Colorfast45® | 55112__ | .32 lbs |
| 26 | PVDF | 56112__ | .32 lbs |
| 24 | ACG | 5711241 | .36 lbs |
| 24 | PVDF | 58112__ | .36 lbs |

4" X 3-1/2" ELBOW

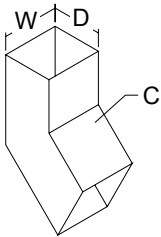
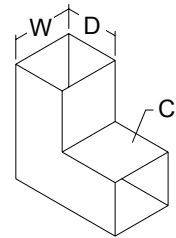

| GAUGE | FINISH | PRODUCT NO. | WEIGHT | TYPE |
|-------|-----------------|-------------|----------|-----------|
| 26 | ACG | 5510241 | 2.00 lbs | 95 Degree |
| 26 | MS Colorfast45® | 55102__ | 2.00 lbs | 95 Degree |
| 26 | PVDF | 56102__ | 2.00 lbs | 95 Degree |
| 24 | ACG | 5710241 | 2.30 lbs | 95 Degree |
| 24 | PVDF | 58102__ | 2.30 lbs | 95 Degree |
| 26 | ACG | 5510641 | 2.00 lbs | 45 Degree |
| 26 | MS Colorfast45® | 55106__ | 2.00 lbs | 45 Degree |
| 26 | PVDF | 56106__ | 2.00 lbs | 45 Degree |
| 24 | ACG | 5710641 | 2.30 lbs | 45 Degree |
| 24 | PVDF | 58106__ | 2.30 lbs | 45 Degree |

6" X 4" ELBOW

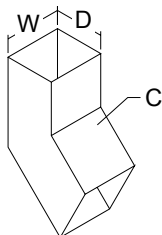
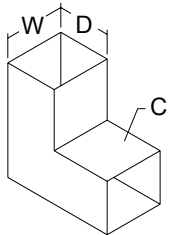

| GAUGE | FINISH | PRODUCT NO. | WEIGHT | TYPE |
|-------|-----------------|-------------|----------|-----------|
| 26 | ACG | 5510441 | 2.00 lbs | 95 Degree |
| 26 | MS Colorfast45® | 55104__ | 2.00 lbs | 95 Degree |
| 26 | PVDF | 56104__ | 2.00 lbs | 95 Degree |
| 24 | ACG | 5710441 | 3.00 lbs | 95 Degree |
| 24 | PVDF | 58104__ | 3.00 lbs | 95 Degree |
| 26 | ACG | 5510841 | 2.00 lbs | 45 Degree |
| 26 | MS Colorfast45® | 55108__ | 2.00 lbs | 45 Degree |
| 26 | PVDF | 56108__ | 2.00 lbs | 45 Degree |
| 24 | ACG | 5710841 | 3.00 lbs | 45 Degree |
| 24 | PVDF | 58108__ | 3.00 lbs | 45 Degree |

PBR-PANEL

FLASHING PROFILES

| PEAK | GAUGE | FINISH | PRODUCT NO. | WEIGHT | LENGTH |
|------|-------|-----------------|-------------|-----------|--------|
| | 26 | ACG | 5502241 | 8.25 lbs | 10'-2" |
| | 26 | ACG | 5502441 | 16.50 lbs | 20'-3" |
| | 26 | MS Colorfast45® | 55022__ | 8.25 lbs | 10'-2" |
| | 26 | MS Colorfast45® | 55024__ | 16.50 lbs | 20'-3" |
| | 26 | PVDF | 56022__ | 8.25 lbs | 10'-2" |
| | 26 | PVDF | 56024__ | 16.50 lbs | 20'-3" |
| | 24 | ACG | 5702241 | 9.95 lbs | 10'-2" |
| | 24 | ACG | 5702441 | 19.90 lbs | 20'-3" |
| | 24 | PVDF | 58022__ | 9.95 lbs | 10'-2" |
| | 24 | PVDF | 58024__ | 19.90 lbs | 20'-3" |

| SCULPTURED HIGH SIDE EAVE | GAUGE | FINISH | PRODUCT NO. | WEIGHT | LENGTH |
|---------------------------|-------|-----------------|-------------|-----------|--------|
| | 26 | ACG | 5502241 | 8.25 lbs | 10'-2" |
| | 26 | ACG | 5502441 | 16.50 lbs | 20'-3" |
| | 26 | MS Colorfast45® | 55022__ | 8.25 lbs | 10'-2" |
| | 26 | MS Colorfast45® | 55024__ | 16.50 lbs | 20'-3" |
| | 26 | PVDF | 56022__ | 8.25 lbs | 10'-2" |
| | 26 | PVDF | 56024__ | 16.50 lbs | 20'-3" |
| | 24 | ACG | 5702241 | 9.95 lbs | 10'-2" |
| | 24 | ACG | 5702441 | 19.90 lbs | 20'-3" |
| | 24 | PVDF | 58022__ | 9.95 lbs | 10'-2" |
| | 24 | PVDF | 58024__ | 19.90 lbs | 20'-3" |

| RAKE | GAUGE | FINISH | PRODUCT NO. | WEIGHT | LENGTH |
|------|-------|-----------------|-------------|-----------|--------|
| | 26 | ACG | 5590441 | 8.10 lbs | 10'-2" |
| | 26 | MS Colorfast45® | 55904__ | 8.10 lbs | 10'-2" |
| | 26 | PVDF | 56904__ | 8.10 lbs | 10'-2" |
| | 24 | ACG | 5790441 | 10.80 lbs | 10'-2" |
| | 24 | PVDF | 59904__ | 10.80 lbs | 10'-2" |

| SCULPTURED RAKE | GAUGE | FINISH | PRODUCT NO. | WEIGHT | LENGTH |
|-----------------|-------|-----------------|-------------|-----------|--------|
| | 26 | ACG | 5591141 | 13.80 lbs | 10'-2" |
| | 26 | ACG | 5591241 | 27.60 lbs | 20'-3" |
| | 26 | MS Colorfast45® | 55911__ | 13.80 lbs | 10'-2" |
| | 26 | MS Colorfast45® | 55912__ | 27.60 lbs | 20'-3" |
| | 26 | PVDF | 56911__ | 13.80 lbs | 10'-2" |
| | 26 | PVDF | 56912__ | 27.60 lbs | 20'-3" |
| | 24 | ACG | 5791141 | 17.70 lbs | 10'-2" |
| | 24 | ACG | 5791241 | 35.40 lbs | 20'-3" |
| | 24 | PVDF | 58911__ | 17.70 lbs | 10'-2" |
| | 24 | PVDF | 58912__ | 35.40 lbs | 20'-3" |

| SCULPTURED RAKE END | GAUGE | FINISH | PRODUCT NO. | WEIGHT | LENGTH |
|---------------------|-------|-----------------|-------------|---------|--------|
| | 26 | ACG | 5504641 | .15 lbs | |
| | 26 | MS Colorfast45® | 55046__ | .15 lbs | |
| | 26 | PVDF | 56046__ | .15 lbs | |
| | 24 | ACG | 5704641 | .18 lbs | |
| | 24 | PVDF | 58046__ | .18 lbs | |

PBR-PANEL

FLASHING PROFILES

RAKEWALL

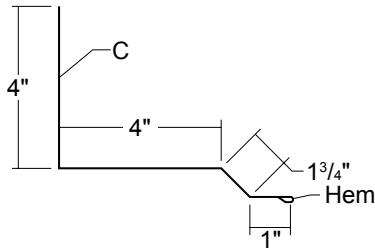

| GAUGE | FINISH | PRODUCT NO. | WEIGHT | LENGTH |
|-------|-----------------|-------------|-----------|--------|
| 26 | ACG | 5590241 | 7.20 lbs | 10'-2" |
| 26 | ACG | 5590341 | 14.40 lbs | 20'-3" |
| 26 | MS Colorfast45® | 55902__ | 7.20 lbs | 10'-2" |
| 26 | MS Colorfast45® | 55903__ | 14.40 lbs | 20'-3" |
| 26 | PVDF | 56902__ | 7.20 lbs | 10'-2" |
| 26 | PVDF | 56903__ | 14.40 lbs | 20'-3" |
| 24 | ACG | 5790241 | 9.60 lbs | 10'-2" |
| 24 | ACG | 5790341 | 19.20 lbs | 20'-3" |
| 24 | PVDF | 58902__ | 9.60 lbs | 10'-2" |
| 24 | PVDF | 58903__ | 19.20 lbs | 20'-3" |

PITCH BREAK

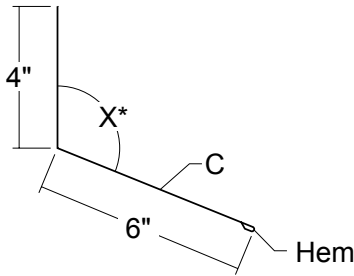

| GAUGE | FINISH | PRODUCT NO. | WEIGHT | LENGTH |
|-------|-----------------|-------------|----------|--------|
| 26 | ACG | 5504841 | 6.90 lbs | 10'-2" |
| 26 | MS Colorfast45® | 55048__ | 6.90 lbs | 10'-2" |
| 26 | PVDF | 56048__ | 6.90 lbs | 10'-2" |
| 24 | ACG | 5704841 | 8.30 lbs | 10'-2" |
| 24 | PVDF | 59048__ | 8.30 lbs | 10'-2" |

COUNTER FLASHING

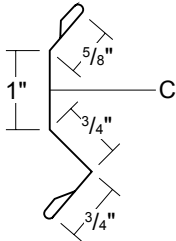

| GAUGE | FINISH | PRODUCT NO. | WEIGHT | LENGTH |
|-------|-----------------|-------------|----------|--------|
| 26 | ACG | 5505241 | 2.75 lbs | 10'-2" |
| 26 | MS Colorfast45® | 55052__ | 2.75 lbs | 10'-2" |
| 26 | PVDF | 56052__ | 2.75 lbs | 10'-2" |
| 24 | ACG | 5705241 | 3.35 lbs | 10'-2" |
| 24 | PVDF | 59052__ | 3.35 lbs | 10'-2" |

REGLET FLASHING

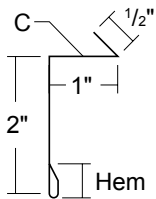

| GAUGE | FINISH | PRODUCT NO. | WEIGHT | LENGTH |
|-------|-----------------|-------------|----------|--------|
| 26 | ACG | 5505441 | 2.65 lbs | 10'-2" |
| 26 | MS Colorfast45® | 55054__ | 2.65 lbs | 10'-2" |
| 26 | PVDF | 56054__ | 2.65 lbs | 10'-2" |
| 24 | ACG | 5705441 | 3.20 lbs | 10'-2" |
| 24 | PVDF | 59054__ | 3.20 lbs | 10'-2" |

GRAVEL STOP

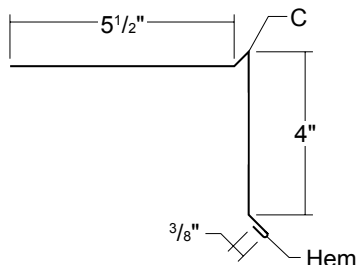

| GAUGE | FINISH | PRODUCT NO. | WEIGHT | LENGTH |
|-------|-----------------|-------------|-----------|--------|
| 26 | ACG | 5503041 | 7.25 lbs | 10'-2" |
| 26 | ACG | 5503241 | 14.50 lbs | 20'-3" |
| 26 | MS Colorfast45® | 55030__ | 7.25 lbs | 10'-2" |
| 26 | MS Colorfast45® | 55032__ | 14.50 lbs | 20'-3" |
| 26 | PVDF | 56030__ | 7.25 lbs | 10'-2" |
| 26 | PVDF | 56032__ | 14.50 lbs | 20'-3" |
| 24 | ACG | 5703041 | 8.80 lbs | 10'-2" |
| 24 | ACG | 5703241 | 17.60 lbs | 20'-3" |
| 24 | PVDF | 58030__ | 8.80 lbs | 10'-2" |
| 24 | PVDF | 58032__ | 17.60 lbs | 20'-3" |

PBR-PANEL

FLASHING PROFILES

SCULPTURED PEAK BOX

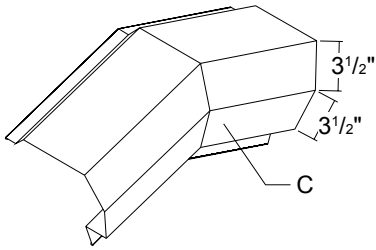

| GAUGE | FINISH | PRODUCT NO. | WEIGHT |
|-------|-----------------|-------------|----------|
| 26 | ACG | 5596341 | 6.00 lbs |
| 26 | MS Colorfast45® | 55963__ | 6.00 lbs |
| 26 | PVDF | 56963__ | 6.00 lbs |
| 24 | ACG | 5796341 | 7.00 lbs |
| 24 | PVDF | 59963__ | 7.00 lbs |

SCULPTURED CORNER BOX

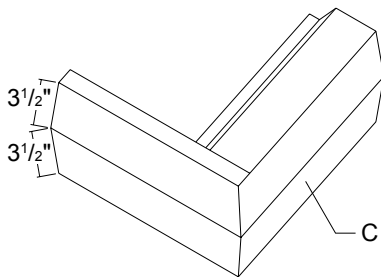

Looking from Eave to Ridge
(Right Shown)

| GAUGE | FINISH | PRODUCT NO. | WEIGHT | SIDE |
|-------|-----------------|-------------|----------|-------|
| 26 | ACG | 5596441 | 7.00 lbs | Left |
| 26 | ACG | 5596241 | 7.00 lbs | Right |
| 26 | MS Colorfast45® | 55964__ | 7.00 lbs | Left |
| 26 | MS Colorfast45® | 55962__ | 7.00 lbs | Right |
| 26 | PVDF | 56964__ | 7.00 lbs | Left |
| 26 | PVDF | 56962__ | 7.00 lbs | Right |
| 24 | ACG | 5796441 | 8.00 lbs | Left |
| 24 | ACG | 5796241 | 8.00 lbs | Right |
| 24 | PVDF | 58964__ | 8.00 lbs | Left |
| 24 | PVDF | 58962__ | 8.00 lbs | Right |

R-PANEL JAMB

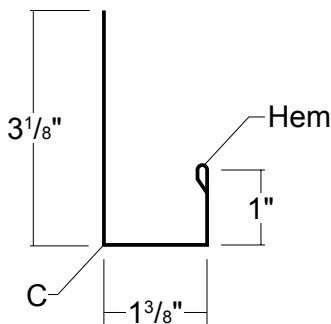

| GAUGE | FINISH | PRODUCT NO. | WEIGHT | LENGTH |
|-------|-----------------|-------------|----------|--------|
| 26 | ACG | 5596641 | 3.00 lbs | 7'-3" |
| 26 | ACG | 5520841 | 4.20 lbs | 10'-2" |
| 26 | ACG | 5596741 | 5.80 lbs | 14'-2" |
| 26 | MS Colorfast45® | 55966__ | 3.00 lbs | 7'-3" |
| 26 | MS Colorfast45® | 55208__ | 4.20 lbs | 10'-2" |
| 26 | MS Colorfast45® | 55967__ | 5.80 lbs | 14'-2" |
| 26 | PVDF | 56966__ | 3.00 lbs | 7'-3" |
| 26 | PVDF | 56208__ | 4.20 lbs | 10'-2" |
| 26 | PVDF | 56967__ | 5.80 lbs | 14'-2" |
| 24 | ACG | 5796641 | 3.60 lbs | 7'-3" |
| 24 | ACG | 5720841 | 5.00 lbs | 10'-2" |
| 24 | ACG | 5796741 | 7.00 lbs | 14'-2" |
| 24 | PVDF | 58966__ | 3.60 lbs | 7'-3" |
| 24 | PVDF | 58208__ | 5.00 lbs | 10'-2" |
| 24 | PVDF | 58967__ | 7.00 lbs | 14'-2" |

C-CLOSURE

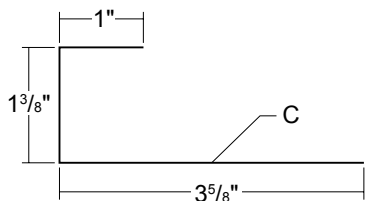

| GAUGE | FINISH | PRODUCT NO. | WEIGHT | LENGTH |
|-------|-----------------|-------------|----------|--------|
| 26 | ACG | 5520641 | 4.00 lbs | 10'-2" |
| 26 | MS Colorfast45® | 55206__ | 4.00 lbs | 10'-2" |
| 26 | PVDF | 56206__ | 4.00 lbs | 10'-2" |
| 24 | ACG | 5720641 | 5.00 lbs | 10'-2" |
| 24 | PVDF | 58206__ | 5.00 lbs | 10'-2" |

PBR-PANEL

FLASHING PROFILES

PBR-PANEL OUTSIDE CORNER

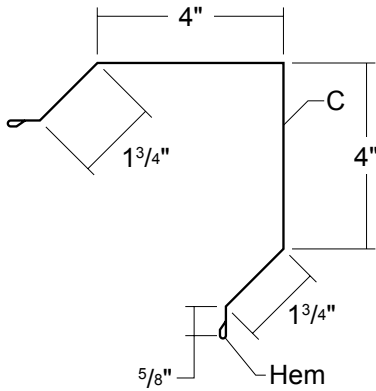

| GAUGE | FINISH | PRODUCT NO. | WEIGHT | LENGTH |
|-------|-----------------|-------------|-----------|--------|
| 26 | ACG | 5591441 | 9.30 lbs | 10'-2" |
| 26 | ACG | 5591541 | 13.05 lbs | 14'-2" |
| 26 | ACG | 5591641 | 18.60 lbs | 20'-3" |
| 26 | MS Colorfast45® | 55914__ | 9.30 lbs | 10'-2" |
| 26 | MS Colorfast45® | 55915__ | 13.05 lbs | 14'-2" |
| 26 | MS Colorfast45® | 55916__ | 18.60 lbs | 20'-3" |
| 26 | PVDF | 56914__ | 9.30 lbs | 10'-2" |
| 26 | PVDF | 56915__ | 13.05 lbs | 14'-2" |
| 26 | PVDF | 56916__ | 18.60 lbs | 20'-3" |
| 24 | ACG | 5791441 | 11.70 lbs | 10'-2" |
| 24 | ACG | 5791541 | 16.20 lbs | 14'-2" |
| 24 | ACG | 5791641 | 23.40 lbs | 20'-3" |
| 24 | PVDF | 58914__ | 11.70 lbs | 10'-2" |
| 24 | PVDF | 58915__ | 16.20 lbs | 14'-2" |
| 24 | PVDF | 58916__ | 23.40 lbs | 20'-3" |

PBR-PANEL INSIDE CORNER

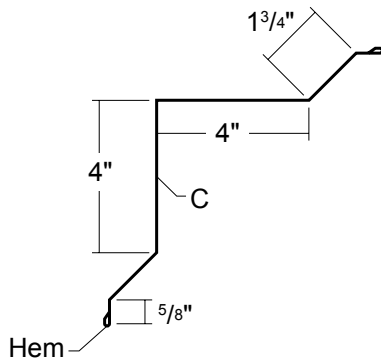

| GAUGE | FINISH | PRODUCT NO. | WEIGHT | LENGTH |
|-------|-----------------|-------------|-----------|--------|
| 26 | ACG | 5591741 | 9.30 lbs | 10'-2" |
| 26 | ACG | 5591841 | 13.05 lbs | 14'-2" |
| 26 | ACG | 5591941 | 18.60 lbs | 20'-3" |
| 26 | MS Colorfast45® | 55917__ | 9.30 lbs | 10'-2" |
| 26 | MS Colorfast45® | 55918__ | 13.05 lbs | 14'-2" |
| 26 | MS Colorfast45® | 55919__ | 18.60 lbs | 20'-3" |
| 26 | PVDF | 56917__ | 9.30 lbs | 10'-2" |
| 26 | PVDF | 56918__ | 13.05 lbs | 14'-2" |
| 26 | PVDF | 56919__ | 18.60 lbs | 20'-3" |
| 24 | ACG | 5791741 | 11.70 lbs | 10'-2" |
| 24 | PVDF | 58917__ | 11.70 lbs | 10'-2" |

OUTSIDE CORNER

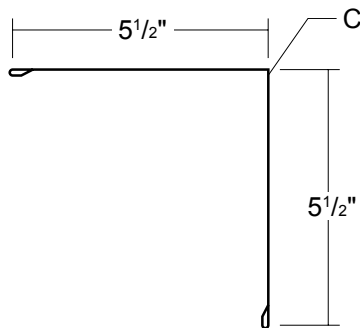

| GAUGE | FINISH | PRODUCT NO. | WEIGHT | LENGTH |
|-------|-----------------|-------------|-----------|--------|
| 26 | ACG | 5513241 | 7.70 lbs | 10'-2" |
| 26 | ACG | 5513641 | 15.40 lbs | 20'-3" |
| 26 | MS Colorfast45® | 55132__ | 7.70 lbs | 10'-2" |
| 26 | MS Colorfast45® | 55136__ | 15.40 lbs | 20'-3" |
| 26 | PVDF | 56132__ | 7.70 lbs | 10'-2" |
| 26 | PVDF | 56136__ | 15.40 lbs | 20'-3" |
| 24 | ACG | 5713241 | 10.20 lbs | 10'-2" |
| 24 | ACG | 5713641 | 20.40 lbs | 20'-3" |
| 24 | PVDF | 58132__ | 10.20 lbs | 10'-2" |
| 24 | PVDF | 58136__ | 20.40 lbs | 20'-3" |

INSIDE CORNER

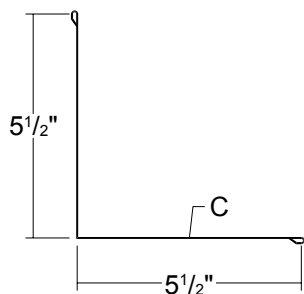

| GAUGE | FINISH | PRODUCT NO. | WEIGHT | LENGTH |
|-------|-----------------|-------------|-----------|--------|
| 26 | ACG | 5512641 | 7.70 lbs | 10'-2" |
| 26 | ACG | 5513041 | 15.40 lbs | 20'-3" |
| 26 | MS Colorfast45® | 55126__ | 7.70 lbs | 10'-2" |
| 26 | MS Colorfast45® | 55130__ | 15.40 lbs | 20'-3" |
| 26 | PVDF | 56126__ | 7.70 lbs | 10'-2" |
| 26 | PVDF | 56130__ | 15.40 lbs | 20'-3" |
| 24 | ACG | 5712641 | 10.20 lbs | 10'-2" |
| 24 | ACG | 5713041 | 20.40 lbs | 20'-3" |
| 24 | PVDF | 58126__ | 10.20 lbs | 10'-2" |
| 24 | PVDF | 58130__ | 20.40 lbs | 20'-3" |

PBR-PANEL

FLASHING PROFILES

1-1/4" BASE

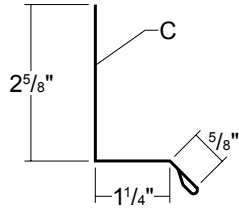

| GAUGE | FINISH | PRODUCT NO. | WEIGHT | LENGTH |
|-------|-----------------|-------------|----------|--------|
| 26 | ACG | 5513841 | 3.25 lbs | 10'-2" |
| 26 | MS Colorfast45® | 55138__ | 3.25 lbs | 10'-2" |
| 26 | PVDF | 56138__ | 3.25 lbs | 10'-2" |
| 24 | ACG | 5713841 | 4.40 lbs | 10'-2" |
| 24 | PVDF | 58138__ | 4.40 lbs | 10'-2" |

1.5" SILL/HEAD

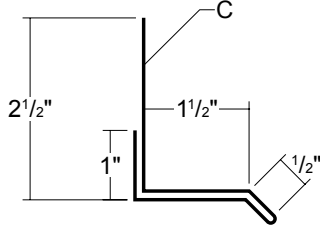

| GAUGE | FINISH | PRODUCT NO. | WEIGHT | LENGTH |
|-------|-----------------|-------------|----------|--------|
| 26 | ACG | 5511441 | 5.20 lbs | 10'-2" |
| 26 | MS Colorfast45® | 55114__ | 5.20 lbs | 10'-2" |
| 26 | PVDF | 56114__ | 5.20 lbs | 10'-2" |
| 24 | ACG | 5711441 | 6.30 lbs | 10'-2" |
| 24 | PVDF | 58114__ | 6.30 lbs | 10'-2" |

1.5" SILL TO SOFFIT

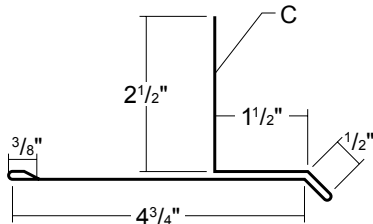

| GAUGE | FINISH | PRODUCT NO. | WEIGHT | LENGTH |
|-------|-----------------|-------------|----------|--------|
| 26 | ACG | 5511841 | 7.20 lbs | 10'-2" |
| 26 | MS Colorfast45® | 55118__ | 7.20 lbs | 10'-2" |
| 26 | PVDF | 56118__ | 7.20 lbs | 10'-2" |
| 24 | ACG | 5711841 | 8.75 lbs | 10'-2" |
| 24 | PVDF | 58118__ | 8.75 lbs | 10'-2" |

HEAD CHANNEL

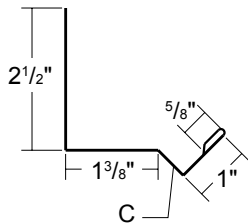

| GAUGE | FINISH | PRODUCT NO. | WEIGHT | LENGTH |
|-------|-----------------|-------------|----------|--------|
| 26 | ACG | 5596041 | 1.60 lbs | 3'-6" |
| 26 | ACG | 5512241 | 4.50 lbs | 10'-2" |
| 26 | MS Colorfast45® | 55960__ | 1.60 lbs | 3'-6" |
| 26 | MS Colorfast45® | 55122__ | 4.50 lbs | 10'-2" |
| 26 | PVDF | 56960__ | 1.60 lbs | 3'-6" |
| 26 | PVDF | 56122__ | 4.50 lbs | 10'-2" |
| 24 | ACG | 5712241 | 5.15 lbs | 10'-2" |
| 24 | PVDF | 58122__ | 5.15 lbs | 10'-2" |

HEAD/JAMB COVER

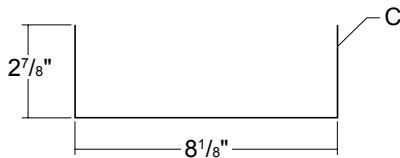

| GAUGE | FINISH | PRODUCT NO. | WEIGHT | LENGTH |
|-------|-----------------|-------------|-----------|--------|
| 26 | ACG | 5512441 | 9.25 lbs | 10'-2" |
| 26 | ACG | 5596141 | 12.25 lbs | 14'-2" |
| 26 | MS Colorfast45® | 55124__ | 9.25 lbs | 10'-2" |
| 26 | MS Colorfast45® | 55961__ | 12.25 lbs | 14'-2" |
| 26 | PVDF | 56124__ | 9.25 lbs | 10'-2" |
| 26 | PVDF | 56961__ | 12.25 lbs | 14'-2" |
| 24 | ACG | 5712441 | 11.00 lbs | 10'-2" |
| 24 | PVDF | 58124__ | 11.00 lbs | 10'-2" |

COPING

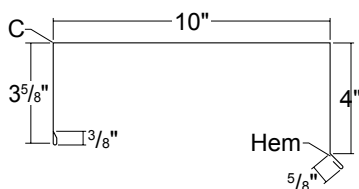

| GAUGE | FINISH | PRODUCT NO. | WEIGHT | LENGTH |
|-------|-----------------|-------------|-----------|--------|
| 26 | ACG | 5502641 | 12.20 lbs | 10'-2" |
| 26 | MS Colorfast45® | 55026__ | 12.20 lbs | 10'-2" |
| 26 | PVDF | 56026__ | 12.20 lbs | 10'-2" |
| 24 | ACG | 5702641 | 15.35 lbs | 10'-2" |
| 24 | ACG | 5702841 | 30.70 lbs | 14'-2" |
| 24 | PVDF | 58026__ | 15.35 lbs | 10'-2" |
| 24 | PVDF | 58028__ | 30.70 lbs | 14'-2" |

PBR-PANEL

ACCESSORIES

| PBR-PANEL CLOSURE | | SIZE | TYPE | PRODUCT NO. | WT/100 | |
|--|--------------------|----------------------------|---------|-------------|----------|---------|
|  <p>Outside Closure</p>  <p>Inside Closure</p> | 1" x 3'-0" | Polyethylene Foam Glued | 6460699 | 9.00 lbs | | |
| | 1" x 3'-0" | Polyethylene Foam Glued | 6460800 | 7.00 lbs | | |
| UNIVERSAL CLOSURE | | SIZE | TYPE | PRODUCT NO. | WT/100 | COLOR |
|  | 1" x 1 1/2" x 50' | Polyethylene Foam | 6411100 | 4.00 lbs | Grey | |
| | | | | | | |
| VERSA VENT | | SIZE | TYPE | PRODUCT NO. | WT/10 | CTN QTY |
|  | 1" x 1 1/2" x 10' | Vented Foam | | | | 10 |
| | | | | | | |
| PROFILE VENT | | SIZE | TYPE | PRODUCT NO. | WEIGHT | CTN QTY |
|  | 3" x 50' | Vented Foam | | | | 2 |
| | | | | | | |
| SINGLE BEAD TAPE SEALANT | | SIZE | TYPE | PRODUCT NO. | WT/CTN | CTN QTY |
|  | 7/8" x 3/16" x 25' | Butyl | 6404099 | 40.00 lbs | 48 Rolls | |
| | | | | | | |
| TUBE SEALANT | | SIZE | TYPE | PRODUCT NO. | WT/CTN | CTN QTY |
|  | 10.3 oz | Urethane White | 6402830 | 30.00 lbs | 30 Tubes | |
| | 10.3 oz | Urethane Bronze | 6402999 | 30.00 lbs | 30 Tubes | |
| | 10.3 oz | Urethane Grey | 6402829 | 30.00 lbs | 30 Tubes | |

PBR-PANEL

ACCESSORIES

LIGHT TRANSMITTING PANEL

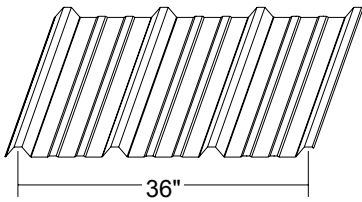

| SIZE | S.F. WEIGHT | PRODUCT NO. | WT/PC | COLOR |
|----------------|-------------|-------------|-----------|-------|
| 3'-0" X 12'-0" | 8 oz | 6190030 | 21.00 lbs | White |

TOUCH-UP PAINT

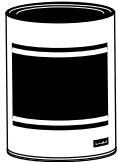

| SIZE | TYPE | PRODUCT NO. | WEIGHT |
|-------------|-----------------|-------------|----------|
| Pint | MS Colorfast45® | 66004__ | 1.60 lbs |
| Pint | PVDF | 66010__ | 1.60 lbs |
| 2 oz Bottle | PVDF | 66005__ | .15 lbs |

RUBBER ROOF DECK FLASHING

Rubber Roof Jack Round Base

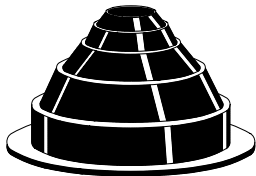

Retro Roof Jack Square Base

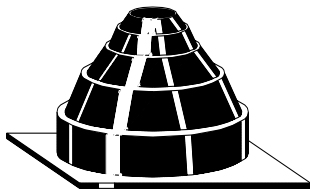

| SIZE | TYPE | PRODUCT NO. | BASE DIA. | WEIGHT |
|------------|--------|-------------|-----------------|-----------|
| #1 Flasher | Rubber | 68501__* | 1/4" - 2" | 3.00 lbs |
| #2 Flasher | Rubber | 68502__* | 1 3/4" - 3 1/4" | 3.00 lbs |
| #3 Flasher | Rubber | 68503__* | 1/4" - 5" | 3.00 lbs |
| #4 Flasher | Rubber | 68504__* | 3" - 6 1/4" | 3.00 lbs |
| #5 Flasher | Rubber | 68505__* | 4 1/4" - 7 1/2" | 5.00 lbs |
| #6 Flasher | Rubber | 68506__* | 5" - 9" | 9.00 lbs |
| #7 Flasher | Rubber | 68507__* | 6" - 11" | 11.00 lbs |
| #8 Flasher | Rubber | 68508__* | 7" - 13" | 13.00 lbs |
| #9 Flasher | Rubber | 68509__* | 10" - 19" | 13.00 lbs |

*Special order colors: 93=Brown; 94=Green; 95=Red; 96=Blue; 97=White; 98=Grey; 99=Black

| | | | | |
|------------|-------------|---------|-----------------|-----------|
| #1 Flasher | HT Silicone | 6850011 | 1/4" - 2" | 3.00 lbs |
| #2 Flasher | HT Silicone | 6850012 | 1 3/4" - 3 1/4" | 3.00 lbs |
| #3 Flasher | HT Silicone | 6850013 | 1/4" - 5" | 3.00 lbs |
| #4 Flasher | HT Silicone | 6850014 | 3" - 6 1/4" | 3.00 lbs |
| #5 Flasher | HT Silicone | 6850015 | 4 1/4" - 7 1/2" | 5.00 lbs |
| #6 Flasher | HT Silicone | 6850016 | 5" - 9" | 9.00 lbs |
| #7 Flasher | HT Silicone | 6850017 | 6" - 11" | 11.00 lbs |
| #8 Flasher | HT Silicone | 6850018 | 7" - 13" | 13.00 lbs |
| #9 Flasher | HT Silicone | 6850019 | 10" - 19" | 13.00 lbs |

| | | | | |
|----------------|-------------|---------|-------------|----------|
| #1 Masterflash | Retrofit HT | 6850060 | 1/4" - 2" | 4.00 lbs |
| #2 Masterflash | Retrofit HT | 6850061 | 1 1/4" - 3" | 4.00 lbs |
| #3 Masterflash | Retrofit HT | 6850062 | 1/4" - 4" | 4.00 lbs |

GRAY ROUND RETRO ROOF JACK

| | | | | |
|----------------|------------------|---------|-------------|----------|
| #1 Masterflash | Retrofit E.P.D.M | 6850073 | 1/4" - 2" | 4.00 lbs |
| #2 Masterflash | Retrofit E.P.D.M | 6850074 | 1 1/4" - 3" | 4.00 lbs |
| #3 Masterflash | Retrofit E.P.D.M | 6850075 | 1/4" - 4" | 4.00 lbs |

BLACK ROUND RETRO ROOF JACK

| | | | | |
|----------------|------------------|---------|-------------|----------|
| #1 Masterflash | Retrofit E.P.D.M | 6850070 | 1/4" - 2" | 4.00 lbs |
| #2 Masterflash | Retrofit E.P.D.M | 6850071 | 1 1/4" - 3" | 4.00 lbs |
| #3 Masterflash | Retrofit E.P.D.M | 6850072 | 1/4" - 4" | 4.00 lbs |

BLACK SQUARE RETRO ROOF JACK

| | | | | |
|----------------|------------------|---------|-------------|----------|
| #1 Masterflash | Retrofit E.P.D.M | 6850046 | 1/4" - 2" | 4.00 lbs |
| #2 Masterflash | Retrofit E.P.D.M | 6850047 | 1 1/4" - 3" | 4.00 lbs |
| #3 Masterflash | Retrofit E.P.D.M | 6850048 | 1/4" - 4" | 4.00 lbs |

PBR-PANEL

ACCESSORIES

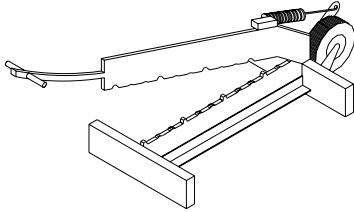
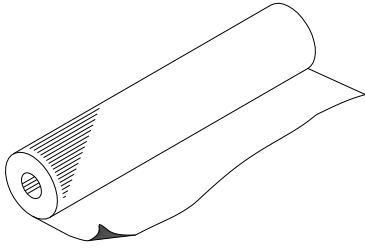
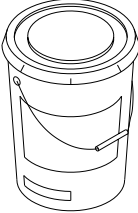
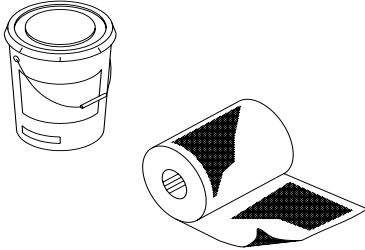
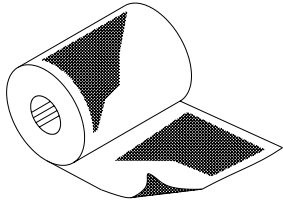
| PBR-PANEL SHEAR | PROFILES | TYPE | PRODUCT NO. | WEIGHT | |
|---|-----------------------|--|-------------|-----------|---|
|  | PBR-Panel and R-Panel | Straight | 6536799 | 85.00 lbs | |
| ms-HT UNDERLAYMENT | SIZE | TYPE | PRODUCT NO. | WT/ROLL | COVERAGE |
|  | 36" x 75'-0" | Peel-n-Stick High Temp Underlayment | 4121200 | 44.00 lbs | 2 Squares/Roll |
| UNDERLAYMENT PRIMER | SIZE | TYPE | PRODUCT NO. | WT/ROLL | COVERAGE |
|  | 5 Gallon | Liquid | 6600000 | 44.00 lbs | 100-125 sf per gallon depending on substrate |
| ALSAN KIT | SIZE | CONTENTS | PRODUCT NO. | WT/ROLL | COVERAGE |
|  | Kit | 1 Gallon Alsan 1 Roll Poly Fleece Tools 1 Instructional Video | 4130300 | 10.00 lbs | 25 sf per gallon depending on weather temperature |
| POLY FLEECE ROLL | SIZE | TYPE | PRODUCT NO. | WT/ROLL | QTY |
|  | 4" x 50' | Poly Fleece | 4130500 | .30 lbs | 1 Roll |
| | 6" x 50' | Poly Fleece | 4130400 | .50 lbs | 1 Roll |

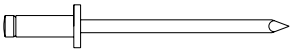
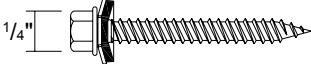
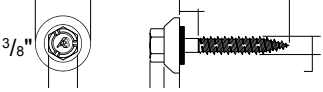
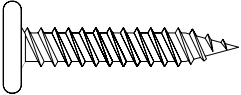
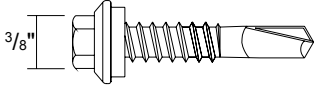
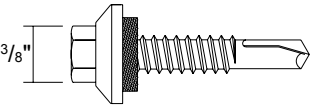
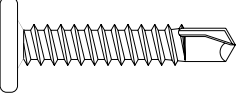
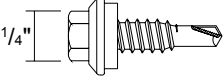
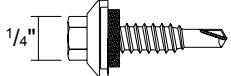

PBR-PANEL

FASTENERS

| POP RIVET | | SIZE | TYPE | PRODUCT NO. | FINISH | WT/250 |
|--|-----------------|----------|---------|-------------|-----------|--------|
|  <p>*Limited stocked colors</p> | 1/8" x 3/16" | Aluminum | 8240901 | Unpainted | .75 lbs | |
| | 1/8" x 3/16" | Aluminum | 82409__ | Painted* | .75 lbs | |
| WOODSCREW | | SIZE | TYPE | PRODUCT NO. | FINISH | WT/250 |
|  | #10-14 x 1" | A | 82101__ | Painted | 4.30 lbs | |
| | #10-14 x 1 1/2" | A | 82103__ | Painted | 5.50 lbs | |
| | #10-14 x 2" | A | 82104__ | Painted | 6.70 lbs | |
| WOODSCREW XL | | SIZE | TYPE | PRODUCT NO. | FINISH | WT/250 |
|  | #10-14 x 1" | A | 8212100 | XL | 6.50 lbs | |
| | #10-14 x 1 1/2" | A | 8212300 | XL | 7.50 lbs | |
| XL Fasteners are recommended for use with bare galvalume panels and flashings. | | | | | | |
| PANCAKE HEAD WOODSCREW | | SIZE | TYPE | PRODUCT NO. | FINISH | WT/250 |
|  | #10-12 x 1" | A | 8243100 | Plated | 6.50 lbs | |
| SELF DRILLER (SD) | | SIZE | TYPE | PRODUCT NO. | FINISH | WT/250 |
|  | #12-14 x 1" | Driller | 82201__ | Painted | 7.80 lbs | |
| | #12-14 x 1 1/2" | Driller | 82203__ | Painted | 8.50 lbs | |
| | #12-14 x 2" | Driller | 82204__ | Painted | 11.00 lbs | |
| SELF DRILLER XL | | SIZE | TYPE | PRODUCT NO. | FINISH | WT/250 |
|  | #12-14 x 1" | Driller | 8235300 | XL | 12.00 lbs | |
| | #12-14 x 1 1/2" | Driller | 8235400 | XL | 13.00 lbs | |
| | #12-14 x 2" | Driller | 8235500 | XL | 14.00 lbs | |
| XL Fasteners are recommended for use with bare galvalume panels and flashings. | | | | | | |
| PANCAKE HEAD SELF DRILLER | | SIZE | TYPE | PRODUCT NO. | FINISH | WT/250 |
|  | #10-16 x 1" | Driller | 8242100 | XL | 6.50 lbs | |
| STITCH | | SIZE | TYPE | PRODUCT NO. | FINISH | WT/250 |
|  | 1/4" -14 x 7/8" | Stitch | 82348__ | Painted | 7.70 lbs | |
| STITCH XL | | SIZE | TYPE | PRODUCT NO. | FINISH | WT/250 |
|  | 1/4" -14 x 7/8" | Stitch | 8236800 | XL | 10.50 lbs | |
| XL Fasteners are recommended for use with bare galvalume panels and flashings. | | | | | | |

PBR-PANEL

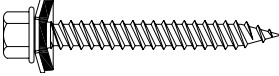
FASTENER PHYSICAL PROPERTIES

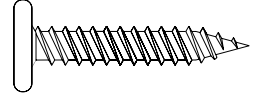
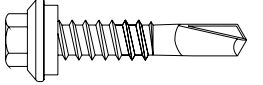
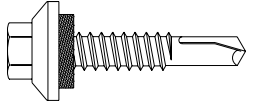
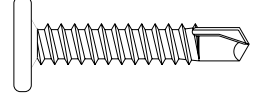
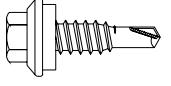
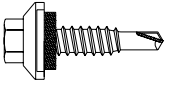
| FASTENER | SIZE | HEAD DIA/TYPE | THREAD DIA. O.D. | THREAD DIA. I.D. | MIN TENSILE | MIN. TORSIONAL | NOM. SHEAR |
|---|---------|---------------|------------------|------------------|-------------|----------------|------------|
| WOODSCREW  | #10-14 | 1/4" HWH | .190-.200 | .128-.133 | | | |
| WOODSCREW XL  | #10-14 | 1/4" HWH | .190-.200 | .128-.133 | | | |
| PANCAKE HEAD WOODSCREW  | | | | | | | |
| SELF DRILLER  | #12-14 | 5/16" HWH | .209-.215 | .157-.165 | 3446 | 128 | 2100 |
| SELF DRILLER XL  | #12-14 | 5/16" HWH | .209-.215 | .157-.165 | 3446 | 130 | 2100 |
| PANCAKE HEAD SELF DRILLER  | | | | | | | |
| STITCH  | 1/4 -14 | 5/16" HWH | .240-.246 | .185-.192 | | | |
| STITCH XL  | 1/4 -14 | 5/16" HWH | .240-.246 | .185-.192 | | | |

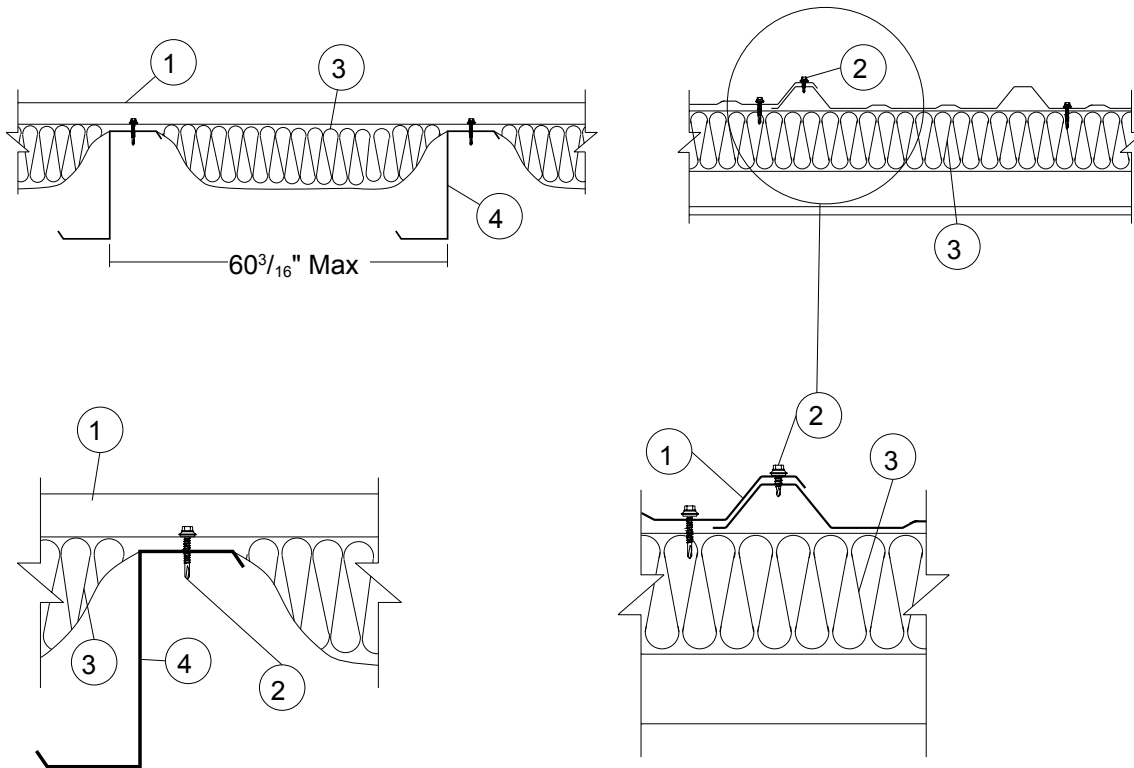

PBR-PANEL

Construction No. 161
 November 02, 2001
 Uplift - Class 90
 Fire Not Investigated

1. Metal Roof Deck PanNo. 26 MSG min gauge coated steel. Panels continuous over two or more spans. End laps to occur over purlins with panels overlapped a min of 4 in. with lap centered over purlin web. A line of tape sealant may be used at panel side and end laps.

Metal Sales Manufacturing Corporation "R-Panel" "PBR-Panel".

2. Panel Fasteners For panel to panel and panel to purlin connections to be No. 12-14 by 1 in. self-drilling, self-tapping, hex head, plated steel screws with a 5/8 in. OD formed steel washer and a neoprene sealing washer.

As alternate Fasteners - For panel to purlin connections, 1/4 - 14 HHAB self-tapping, plating steel screws, with a separate 5/8 in. OD dome shaped steel washer and a neoprene sealing washer may be used.

Or: No. 14-10HHA, self-tapping, plating steel screws, with a separate, 5/8 in. OD dome shaped steel washer and a neoprene sealing washer may be used.

Spacing, for panel - to - purlin connections to be 12 in. on center beginning 2 - 1/2 in. from center line on one side of each major rib. Spacing at end lap to be in a 5 - 7 - 5 - 7 in. pattern beginning 2 - 1/2 in. from the center line on both sides of each major rib.

Fastener for panel to purlin connection to be 1-1/4 in. long when insulation (Item 3) is greater that 4-1/2 in.

Spacing for panel - to - panel connections to be 20 in. on center with a fastener located in line with the purlin fasteners.

3. Insulation (Optional) - Any compressible blanket insulation 6 in. max thickness before compression.

4. Purlin No. 16 MSG min gauge steel (50,000 psi min yield).

5. Lateral Bracing (Not shown) - As required.

Refer to General Information, Roof Deck Construction, (Roofing Materials and Systems Directory) for items not evaluated.

* Bearing the UL Classification Mark.



Underwriters Laboratories Inc. ®
 LISTED

PBR-PANEL

SECTION PROPERTIES

R-PANEL

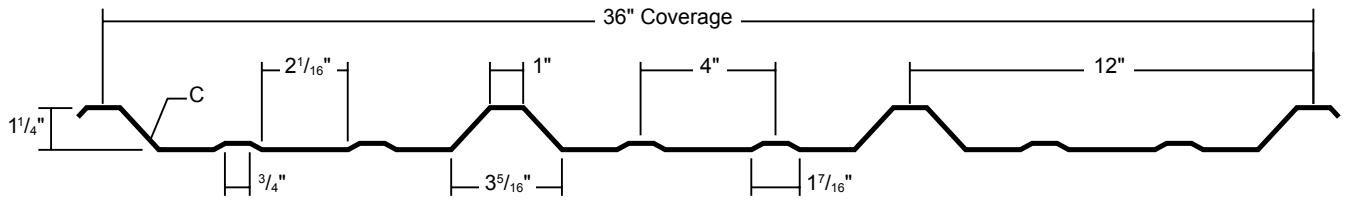

SECTION PROPERTIES

ALLOWABLE UNIFORM LOADS PSF (3 or More Equal Spans)

| Ga. | Width (in.) | Yield KSI | Weight PSF | Top in Compression | | Bottom in Compression | | Inward Load | | | | | | | Outward Load | | | | | | |
|-----|-------------|-----------|------------|-------------------------------------|-------------------------------------|-------------------------------------|-------------------------------------|-------------|-----|-----|----|----|----|-----|--------------|-----|-----|----|----|--|--|
| | | | | I _{xx} In ⁴ /ft | S _{xx} In ³ /ft | I _{xx} In ⁴ /ft | S _{xx} In ³ /ft | 2' | 3' | 4' | 5' | 6' | 7' | 2' | 3' | 4' | 5' | 6' | 7' | | |
| | | | | | | | | | | | | | | | | | | | | | |
| 26 | 36" | 80 | 0.87 | 0.0350 | 0.0348 | 0.0293 | 0.0439 | 235 | 119 | 71 | 47 | 27 | 17 | 270 | 132 | 77 | 50 | 35 | 26 | | |
| 24 | 36" | 50 | 1.13 | 0.0543 | 0.0558 | 0.0427 | 0.0595 | 316 | 147 | 85 | 55 | 38 | 27 | 398 | 185 | 106 | 68 | 48 | 35 | | |
| 22 | 36" | 50 | 1.45 | 0.0767 | 0.0814 | 0.0600 | 0.0790 | 434 | 199 | 113 | 73 | 51 | 37 | 594 | 273 | 155 | 100 | 70 | 51 | | |

- Theoretical Section Properties have been calculated per AISI 2007 "North American Specification for the Design of Cold-Formed Steel Structural Members". I_{xx} & S_{xx} are effective section properties for deflection and bending.
- Allowable load is calculated in accordance with AISI 2007 specification considering : bending, shear, combined bending and shear, deflection and ASTM E 1592 testing for 24 ga and 22 ga. Allowable load is base on 3 or more equal span condition. Allowable load does not consider panel weight, web crippling, fasteners / support conditions or testing for 26 gauge.
- Deflection consideration is limited by a maximum deflection ratio of L/180 of span.
- Allowable loads do not include a 1/3 stress increase in uplift.

PBR-PANEL

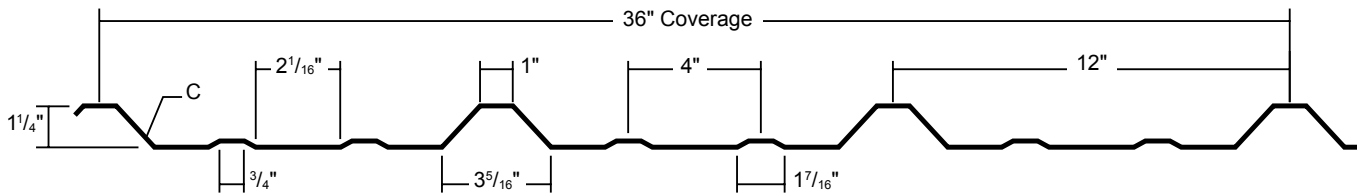

SECTION PROPERTIES

ALLOWABLE UNIFORM LIVE LOADS PSF (3 or More Equal Spans)

| Ga. | Width (in.) | Yield KSI | Weight PSF | Top in Compression | | Bottom in Compression | | Inward (Gravity / Deflection) Load | | | | | | | Outward Uplift (Stress) Load | | | | | | |
|-----|-------------|-----------|------------|-------------------------------------|-------------------------------------|-------------------------------------|-------------------------------------|------------------------------------|-----|-----|----|----|----|-----|------------------------------|-----|----|----|----|--|--|
| | | | | I _{xx} In ⁴ /ft | S _{xx} In ³ /ft | I _{xx} In ⁴ /ft | S _{xx} In ³ /ft | 2' | 3' | 4' | 5' | 6' | 7' | 2' | 3' | 4' | 5' | 6' | 7' | | |
| | | | | | | | | | | | | | | | | | | | | | |
| 26 | 36" | 80 | 0.84 | 0.0367 | 0.0367 | 0.0317 | 0.0458 | 261 | 129 | 76 | 49 | 35 | 23 | 223 | 107 | 62 | 40 | 28 | 21 | | |
| 24 | 36" | 50 | 1.09 | 0.0560 | 0.0579 | 0.0457 | 0.0613 | 330 | 153 | 88 | 57 | 39 | 29 | 314 | 145 | 83 | 53 | 37 | 27 | | |
| 22 | 36" | 50 | 1.43 | 0.0800 | 0.0860 | 0.0633 | 0.0816 | 453 | 207 | 118 | 76 | 53 | 39 | 474 | 218 | 124 | 80 | 55 | 40 | | |

- Theoretical Section Properties have been calculated per AISI 2007 "North American Specification for the Design of Cold-Formed Steel Structural Members". I_{xx} & S_{xx} are effective section properties for deflection and bending.
- Allowable load is calculated in accordance with AISI 2007 specification considering : bending, shear, combined bending and shear, deflection and ASTM E 1592 testing for 24 ga and 22 ga. Allowable load is base on 3 or more equal span condition. Allowable load does not consider panel weight, web crippling, fasteners / support conditions or testing for 26 gauge.
- Deflection consideration is limited by a maximum deflection ratio of L/180 of span.
- Allowable loads do not include a 1/3 stress increase in uplift.

RECEIVING MATERIAL

It is the responsibility of the installer to unload material from the delivery truck. The installer shall be responsible for providing suitable equipment for unloading of material from the truck.

After receiving material, check the condition of the material, and review the shipment against the shipping list to ensure all materials are accounted for. If damages or shortages are discovered, it should be noted on the Bill of Lading at the time of delivery. A claim should be made against the carrier as soon as possible. Metal Sales is not responsible for any damages or shortages unless they are documented in writing and presented to Metal Sales within 48 hours.

GENERAL HANDLING

Each bundle should be handled carefully to avoid being damaged. Care should be taken to prevent bending of the panel or abrasion to finish. Whenever possible, the bundle should remain crated until it is located in its place of storage. If bundles must be opened, we recommend you re-crate them before lifting. To avoid damage please lift the bundle at its center of gravity.

CAUTION

Improper loading and unloading of bundles and crates may result in bodily harm and/or material damage. Metal Sales is not responsible for bodily injuries and/or material damages resulting from improper loading and unloading.

MECHANICAL HANDLING

Forklift - A forklift may be used for panels up to 20'-0" long. Please make sure the forks are at their maximum separation. Do not transport open bundles. When transporting bundles across rough terrain, or over a longer distance, some means of supporting the panel load must be used.

Crane - A crane should be used when lifting panels with lengths greater than 20'-0". Please be sure to utilize a spreader bar to ensure the even distribution of the weight to the pick up points. As a rule when lifting panels, no more than $\frac{1}{3}$ of the length of the panel should be left unsupported. Never use wire rope because this will damage the panels.

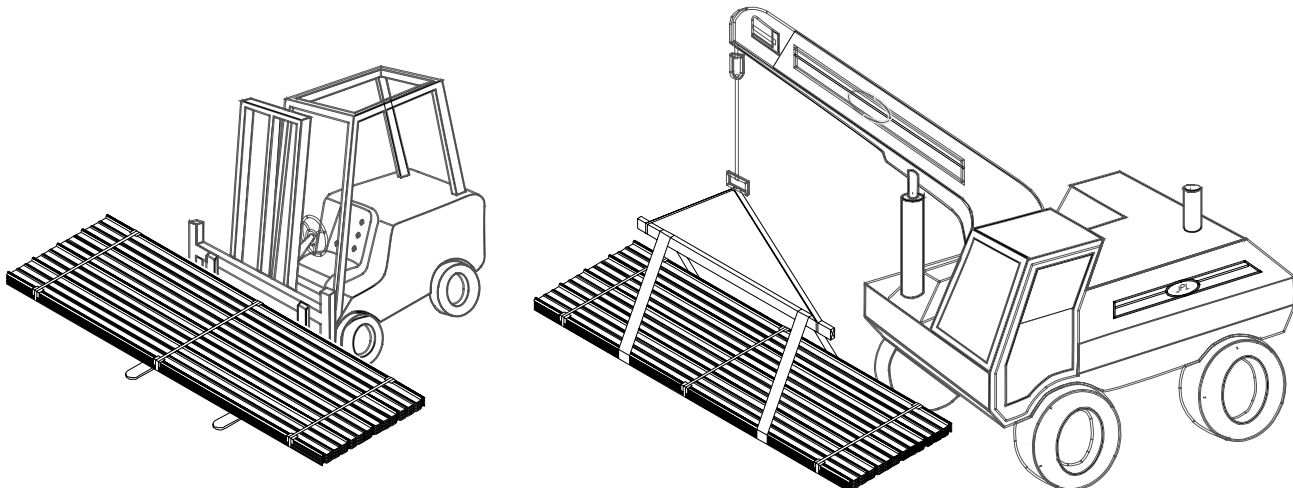

MANUAL HANDLING

When handling painted steel care should be taken to prevent scratching of material. Clean gloves should be worn at all times to prevent a reaction with salts found on bare skin. Installers should wear rubber sole shoes to keep from scuffing material while walking on the roof.

Handling of individual panels should be done carefully and properly to avoid bending or damaging. PBR-Panels should be carried by grasping the edge of the panel so that the PBR-Panel is vertical to the ground. The PBR-Panel should not be carried with the panel horizontal to the ground as this could cause the panel to buckle or bend in the center.

Normally individual panels can be handled by people placed every 6'-0" to 8'-0" along the length of the panel.

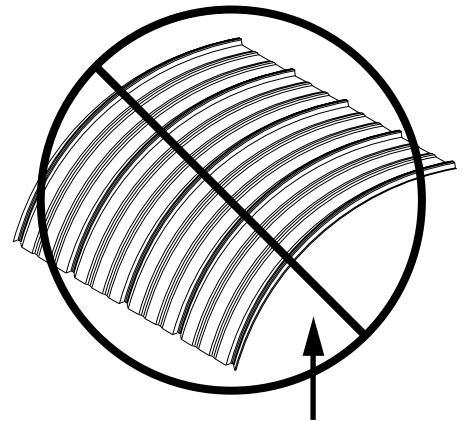
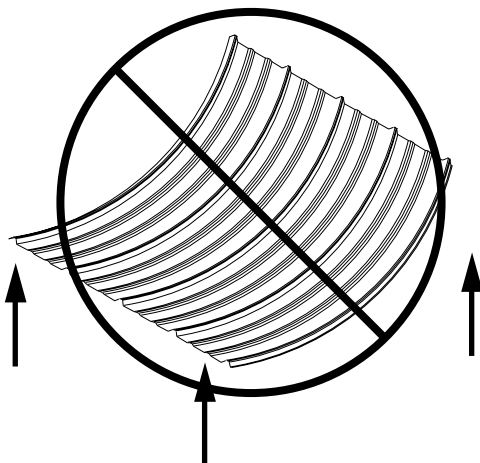
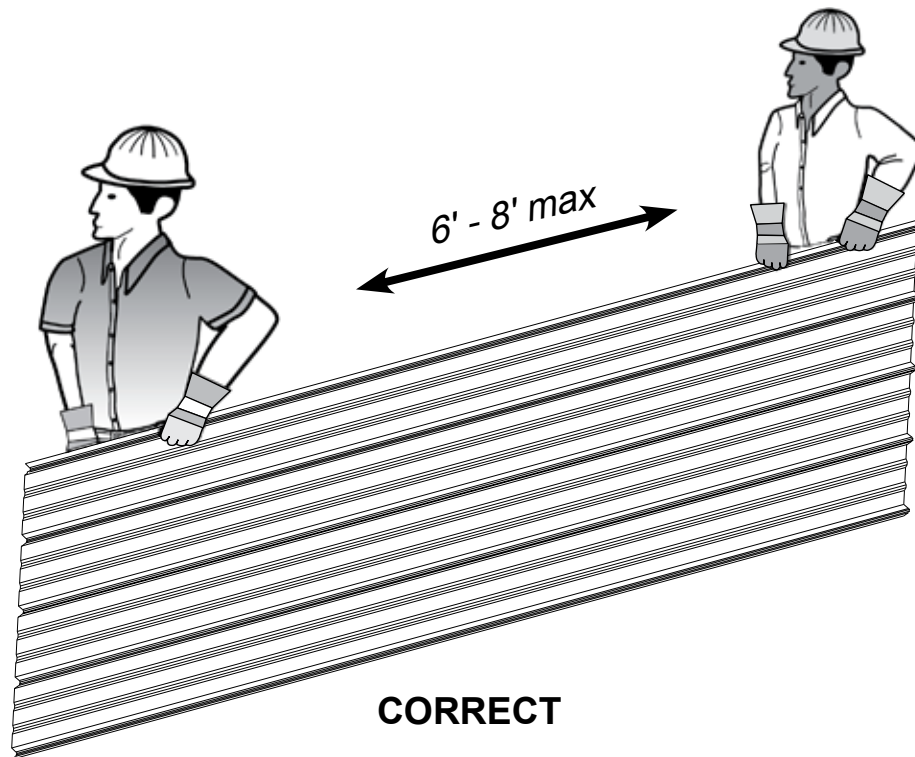

INCORRECT

GENERAL

Please inspect panels for moisture accumulation. If moisture has formed, the panels should be unbundled, wiped dry, and allowed to dry completely. Once dry, carefully re-stack the panels and loosely recover allowing for ample air circulation.

Bundled sheets should be stored high enough off of the ground to allow for air circulation and prevent contact with accumulating water. Elevate one end of the bundle to allow any moisture to run off the panels. Metal Sales recommends covering the bundle with a tarp. Do not use tight fitting plastic-type tarps as panel bundle covers. While they may provide protection from heavy downpours, they can also retard necessary ventilation and trap heat and moisture that may accelerate metal corrosion. If panels are to be stored in possible bad weather, we suggest they be stored inside. Extended storage of panels in a bundle is not recommended. **Under no circumstances should the panels be stored near or come in contact with salt water, corrosive chemicals, ash, or fumes generated or released inside the building or nearby plants, foundries, plating works, kilns, fertilizer, and wet or green lumber.**

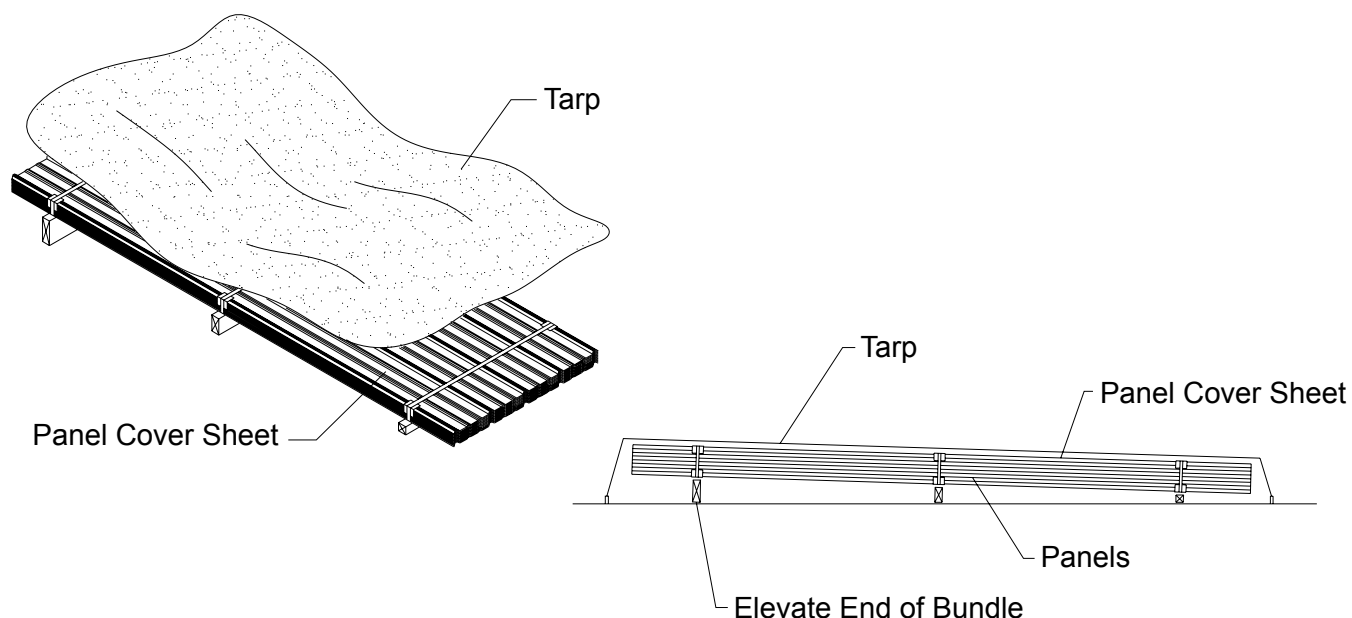

FOOT TRAFFIC

Care of metal panels and flashings must be exercised throughout erection. Foot traffic can cause distortion of panel and damage to finish. Traffic over the installed system must be kept to an absolute minimum. Installers should wear rubber sole shoes to keep from scuffing material while walking on the roof.

When walking on the roof panels is unavoidable, walk only in the flats of the panel. Walking on the ribs can cause damage to the panels.

REQUIRED TOOLS

Standard required tools for field installation include:

- Screw Guns
- Magnetic Bits
- Metal Nibbler or Shear
- Tin Snips
- Tape Measure
- Hammer
- Chalk Line
- Power Drill
- Drill Bits
- Pop Rivet Gun
- Safety Goggles
- Gloves
- Ear Plugs
- Fall Protection

CONDITION OF SUBSTRUCTURE

Metal Sales' panels are designed to be installed over open framing and/or directly over a wood substrate (minimum 5/8") with 30# felt moisture barrier (or an Ice and Water Shield when required by Local Building Codes).

Always check with local building codes prior to all installations for any additional requirements that may be specific to your area.

Galvanized and Galvalume panels should not be in contact with, or subject to, water runoff from copper, lead, or uncoated steel materials.

Condensate water from air conditioning units typically contains dissolved copper. This condensate should be discharged through a plastic pipe extended beyond the edge of the roof.

The roof should be inspected for any trapped moisture or structural damage such as bowing or sagging rafters and warped or loose roof purlins or solid decking. These areas should be repaired prior to installing new metal panels.

Prior to installation, make sure there are no nails or fasteners protruding from the roof framing or wood substrate which could damage the panels and impede the installation process.

When installed, panel distortion may occur if not applied over properly aligned and uniform substructure.

Whether installing over new or existing roof, the installer should check the roof deck for squareness before installing panels. Several methods can be used to verify squareness of the structure for proper installation of the panels.

METHOD "A" - One method for checking the roof for squareness is to measure diagonally across one slope of the roof from similar points at the ridge and eave and obtain the same dimension.

METHOD "B" - The 3-4-5 triangle system may also be used. To use this system, measure a point from the corner along the edge of the roof at a module of three (3). Measure a point from the same corner along another edge at a module of four (4).

By measuring diagonally between the two points established, the dimension should be exactly a module of five (5) to have a square corner. Multiple uses of this system may be required to determine building squareness. If the endwall cannot be made square, the roof system cannot be installed as shown in these instructions.

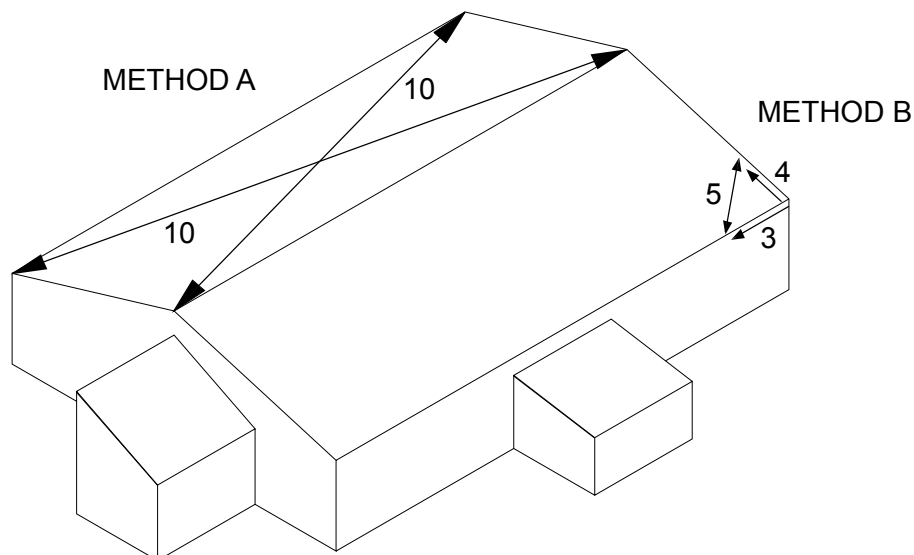

FIELD CUTTING

Tin snips or a "nibbler" type electric tool are recommended for field cutting metal panels. Cutting the steel generates slivers or metal chips. These slivers and metal chips must be immediately removed from the panels because they will damage the finish and shorten the life of the product.

One method of preventing this problem is to flip the panels over when cutting. This allows the slivers and metal chips to be brushed from the back side and avoids damaging the paint on the top side of the panels.

When cutting metal panels and flashings, goggles must be worn for eye protection.

CAUTION

All product surfaces should be free of debris at all times. Installed surfaces should be wiped clean at the end of each work period. Never cut panels over metal surfaces. Metal shavings will rust on the surface, voiding the warranty.

TOUCH-UP PAINT

All painted panels and flashings have a factory applied baked on finish. Handling and installing panels may result in some small scratches or nicks to the paint finish. Touch-up paint is available in matching colors from Metal Sales. It is recommended that a small brush be used to apply touch-up paint to those areas that are in need of repair. Touch-up paint does not have the superior chalk and fade resistance of the factory applied paint finish and will normally discolor at an accelerated rate. Aerosol paint should not be used because of the over-spray that may occur.



SPRAY PAINT

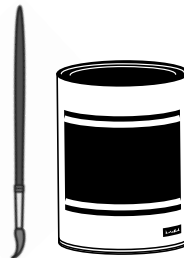

TOUCH-UP PAINT

VENTILATION

Proper design and installation of vapor barriers and ventilation systems are important to prevent condensation and the resulting problems of moisture damage and loss of insulation efficiency.

Condensation occurs when moisture laden air comes in contact with a surface temperature equal to or below the dew point of the air. This phenomenon creates problems that are not unique with metal buildings; these problems are common to all types of construction.

The underside of the metal roof on a typical metal building (no attic) should be protected from condensation by insulating with a faced insulation. This should reduce the potential of condensation forming on the underside of the panels.

On buildings that have an attic space or are being retrofitted with a metal roofing system, vents should be placed at both the eave and peak of the roof in order to prevent a buildup of moisture (humidity) in the attic space.

Though factory applied pre-painted finishes are very durable and will last many years, eventually it may be desirable to thoroughly clean or repaint them.

Dirt pickup may cause apparent discoloration of the paint when it has been exposed in some dirt-laden environments for long periods of time. In areas of strong sunlight, slight chalking may cause some change in appearance. A good cleaning will often restore the appearance of these buildings and render repainting unnecessary. An occasional light cleaning will help maintain a good appearance.

In many cases, simply washing the building with plain water using a hose or pressure sprayer will be adequate. In areas where heavy dirt deposits dull the surface, a cloth or soft bristle brush and solution of water and detergent ($\frac{1}{3}$ cup of laundry detergent per gallon of water for example) may be used. This should be followed by an adequate rinse of water. Do not use wire brushes, abrasives, or cleaning tools which will damage the coating surface.

Mildew may occur in areas subject to high humidity but is not normally a problem due to the high inherent mildew resistance of the baked finish that is used. To remove mildew along with the dirt, the following solution is recommended.

- $\frac{1}{3}$ cup detergent (Tide® or equivalent)
- $\frac{2}{3}$ cup trisodium phosphate (Solex® or equivalent)
- 1 quart of 5% sodium hypochlorite solution (Clorox® or equivalent)
- 3 quarts of water

Strong solvents and abrasive type cleaners should be avoided. Most organic solvents are flammable and toxic and must be handled accordingly. When using a solvent, consult maintenance professionals and label instructions for proper handling and disposal of washings. If required, a mild solvent such as mineral spirits can be used to remove caulking compounds, oil, grease, tars, wax, and similar substances. Use a cloth dampened with mineral spirits and apply only to areas which are contaminated. Follow up the use of this mild solvent with detergent cleaning and rinsing.

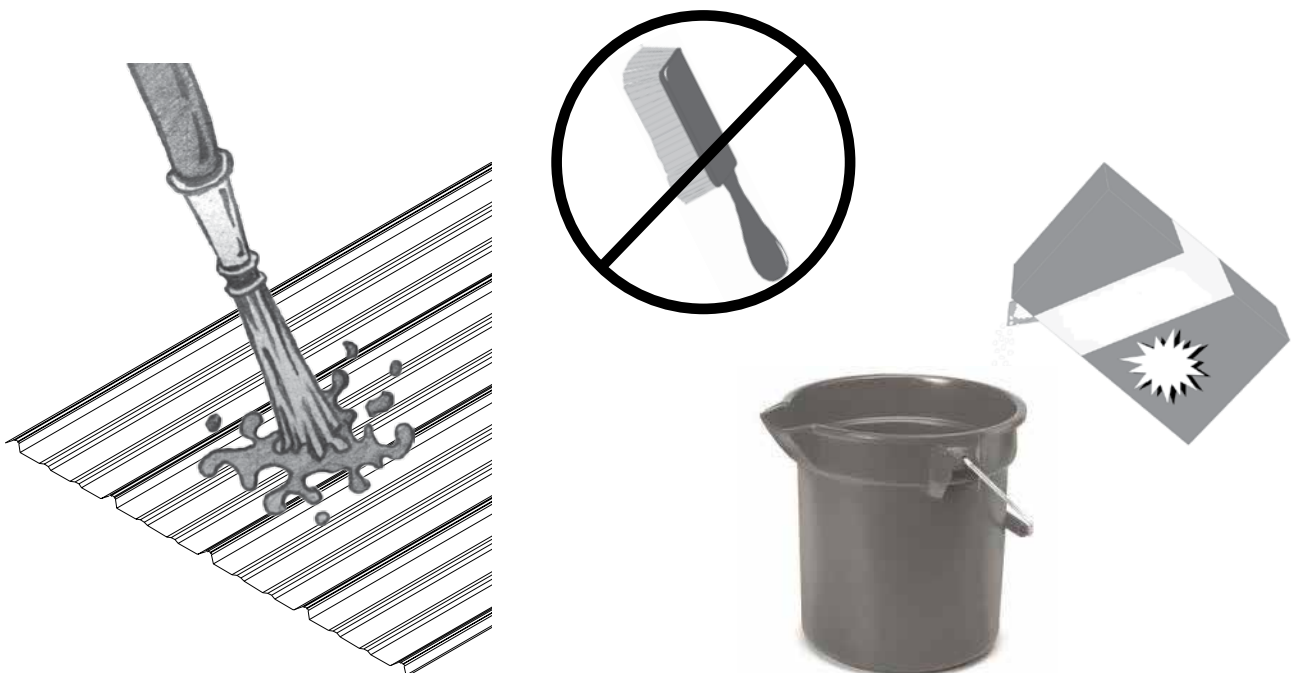

FASTENER INSTALLATION TECHNIQUE

Recommended Tool Type - Use depth locating nose or adjustable clutch on screw gun to prevent over-drilling and strip out. **Do not use impact tools or runners.**

Seating the washer - Apply sufficient torque to seat the washer - do not overdrive the fastener.

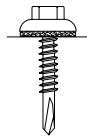
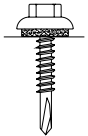
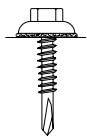
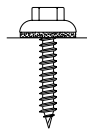
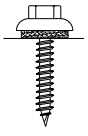
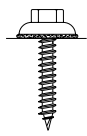
| | CORRECT Sealing material slightly visible at edge of metal washer. Assembly is watertight. | TOO LOOSE Sealing material is not visible; not enough compression to seal properly. | TOO TIGHT Metal washer deformed; sealing material pressed beyond washer edge. |
|--------------|--|---|---|
| SELF DRILLER |  |  |  |
| WOODSCREW |  |  |  |

To prevent wobbling - Make sure fastener head is completely engaged in the socket. If the head does not go all the way in the socket - tap the magnet deeper into the socket to allow full head engagement. Metal chips will build up from drilling and should be removed from time to time.

Protect drill point - Push only hard enough on the screw gun to engage clutch. This prevents excess friction and burn out of the drill point. Correct pressure will allow screw to drill and tap without binding.

Drilling through sheet and insulation - Ease up on pressure when drilling through insulation to avoid striking the purlin or girt with the point - apply more pressure after drill point contacts purlin or girt.

Drilling through purlin overlaps - Drilling through lapped purlins requires extra care. Excessive voids between purlins sometimes damages drill points and two self-drillers might be necessary to complete the operation. It is sometimes advantageous to predrill.

NOTES

- As shown below with the number designations, install panel against the prevailing wind. Installing Wall Panels first then Roof Panels
- To minimize corrosion, siding panels should not be installed all the way to the ground.
- Siding panels should lap over the foundations or splash boards at least three inches.
- Make sure panels are square and plumb, to assure straight and proper alignment of the entire row of panels.
- For areas with high wind considerations, closer fastener spacing may be required.
- It is necessary to attach a temporary guide to the foundation to use as an alignment guide when installing siding panels.

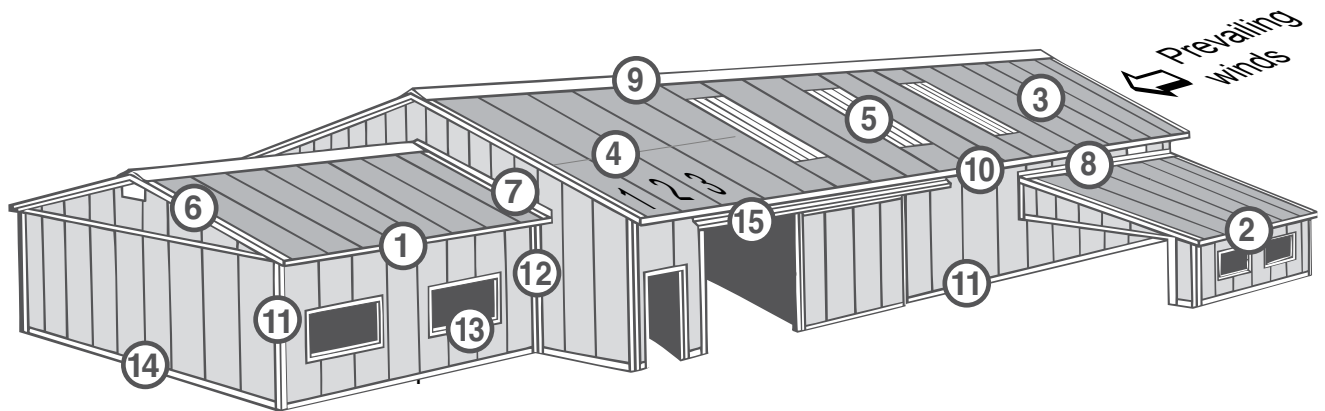

| # | ROOF PANEL DETAILS | PAGE(S) | # | ROOF PANEL DETAILS | PAGE(S) |
|---|---------------------------|---------|----|---------------------------|----------------|
| - | ms-HT Install | 34 | 7 | Rakewall | 46 |
| 1 | Eave Flashing | 35 | 8 | Endwall | 47 |
| - | Valley | 36 | 9 | Ridge | 48 |
| 3 | Roof Panel Install | 37-38 | 10 | Sculptured Gutter | 49 |
| 4 | Endlap | 39 | # | WALL PANEL DETAILS | PAGE(S) |
| 5 | Light Transmitting Panels | 40 | 11 | Outside Corner | 50 |
| - | Rubber Roof Jack | 41 | 12 | Inside Corner | 51 |
| - | Formed Ridge | 42 | 13 | Jamb | 52 |
| - | Ridge/Hip Flashing | 43 | 14 | Base | 53 |
| 6 | Sculptured Rake | 44 | 17 | Head Channel | 54 |
| 6 | Rake | 45 | - | Gravel Stop | 55 |

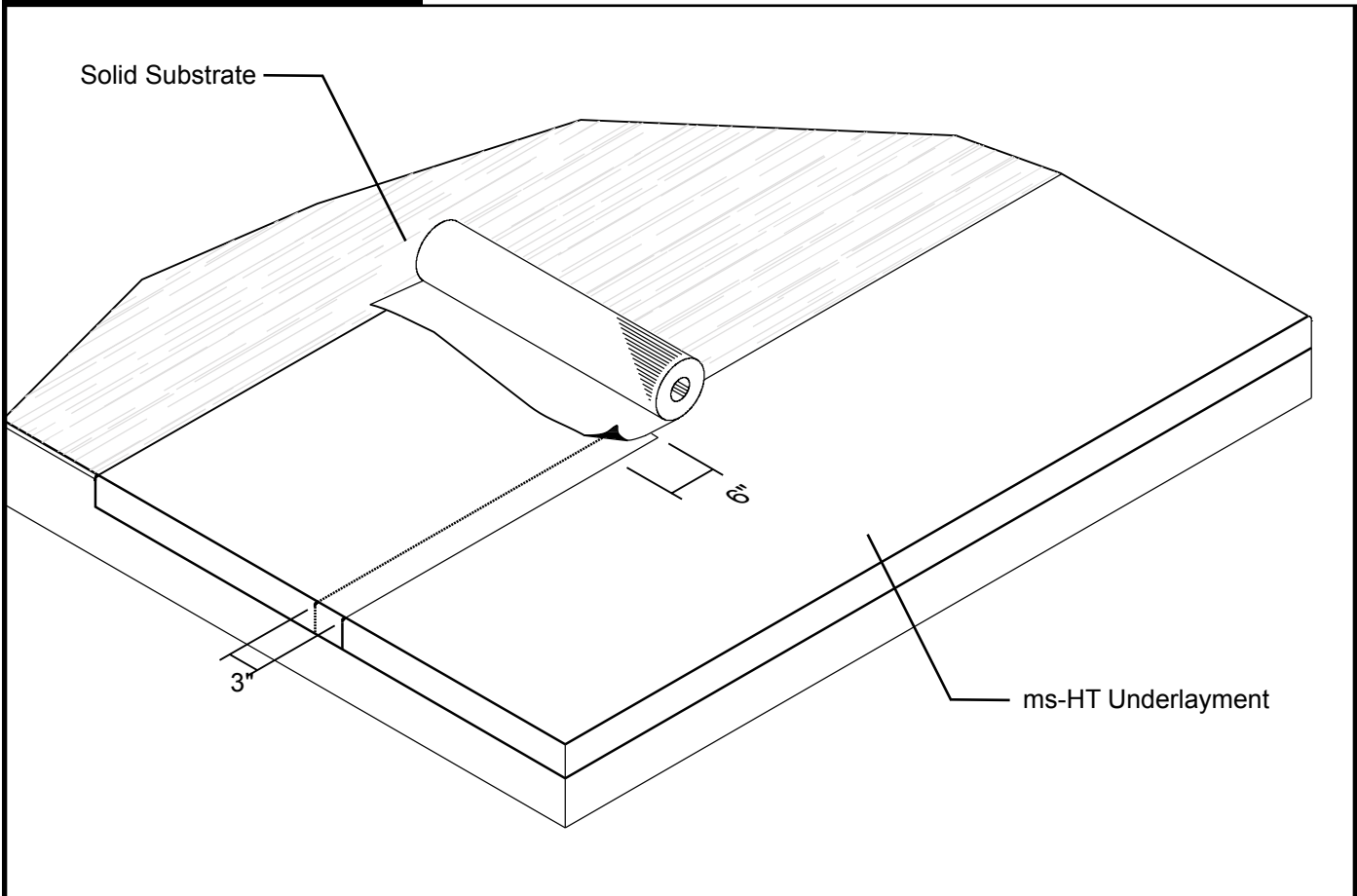
**GENERAL INFORMATION**

- ▶ Thickness: 40 mil
- ▶ Dimensions: 67' x 3'
- ▶ Gross Coverage: 200 ft²
- ▶ Net Coverage: 183 ft²
- ▶ Roll Weight: 43 lbs
- ▶ Installation Temperature: Above 50°

INSTALLATION STEPS

Note: ms-HT is a SBS modified bitumen self adhesive membrane intended to be used as a roofing underlayment. It has a slip resistant surface and will seal around penetrating fasteners.

1. Before installing the PBR-Panel roof it is recommended that a high-temperature underlayment (ms-HT) be installed on the solid substrate.
2. The ms-HT should extend over the edge of the roof surface a minimum of 2" on each side.
3. Start at the low side of the roof and roll out horizontally across the roof substructure.
4. If more than 1 roll is required as it is installed then the ms-HT must be overlapped a minimum of 6".
5. Once the bottom row is down and secure the next row is installed upslope of the first row. Lap the ms-HT a minimum of 3".

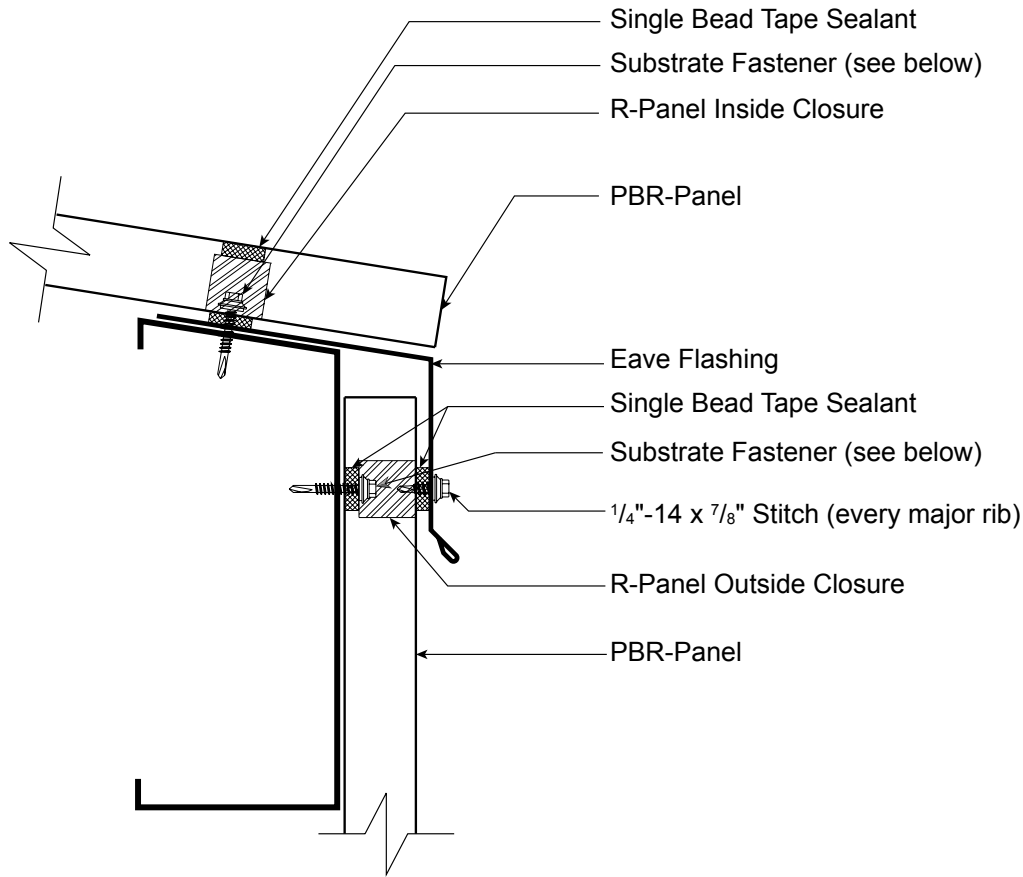

SUBSTRATE FASTENER INFORMATION

Open Framing

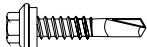

Self Driller
 #12-14 x 1"
 #12-14 x 1-1/2"
 #12-14 x 2"

Solid Wood Substrate



Woodscrew
 #10-14 x 1"
 #10-14 x 1-1/2"
 #10-14 x 2"

2X Wood Framing



Woodscrew
 #10-14 x 1"
 #10-14 x 1-1/2"
 #10-14 x 2"

PBR-PANEL FASTENING PATTERN

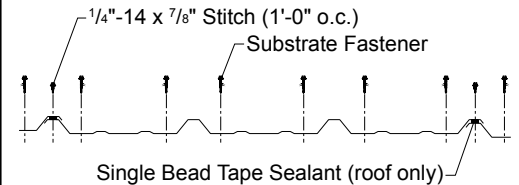

INSTALLATION STEPS

Note: If you are installing an Eave Flashing where there is wall panel, the wall panel must be installed first.

1. Place the Eave Flashing at the eave and mark where the bottom of the Eave Flashing hits the wall panel.
2. Apply a row of Single Bead Tape Sealant along the top of the wall panel so that it is above your mark and below the fasteners at the top of the wall panel.
3. Place an Outside Closure or a Universal Closure over the Single Bead Tape Sealant.
4. Apply a second row of Single Bead Tape Sealant to the outside face of the wall closures along the eave.
5. Install the eave flashing flush against the wall panels, making sure to hide the closure, and fasten to the wall panel with a Stitch Fastener through the sealant and closure, at every major rib.
6. Fasten the top of the Eave Flashing to the roof deck with the appropriate Pancake Head Fastener, four feet on center to hold the Eave Flashing in place until the roof panels can be installed.

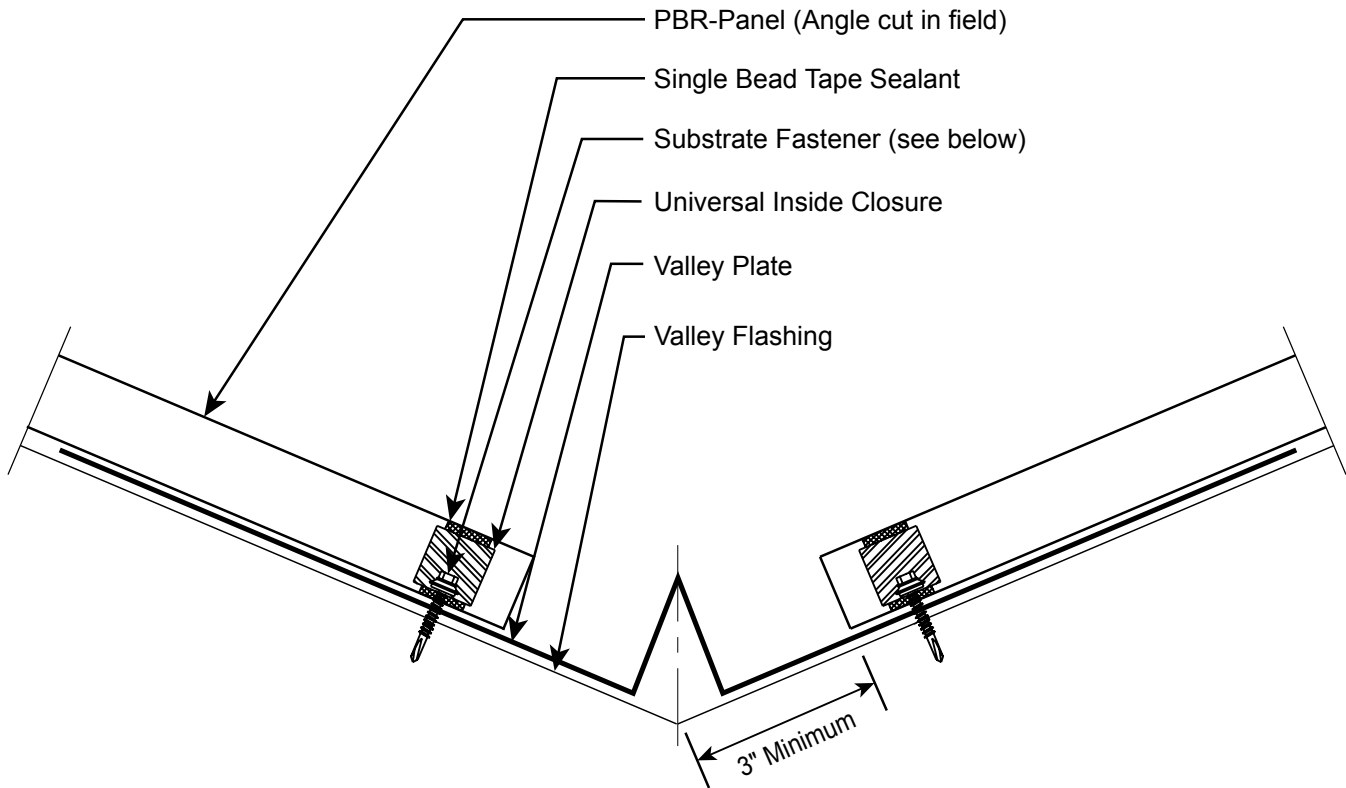

SUBSTRATE FASTENER INFORMATION

PBR-PANEL FASTENING PATTERN

Open Framing

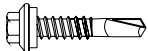

Self Driller
 #12-14 x 1"
 #12-14 x 1-1/2"
 #12-14 x 2"

Solid Wood Substrate

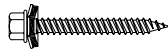

Woodscrew
 #10-14 x 1"
 #10-14 x 1-1/2"
 #10-14 x 2"

2X Wood Framing



Woodscrew
 #10-14 x 1"
 #10-14 x 1-1/2"
 #10-14 x 2"

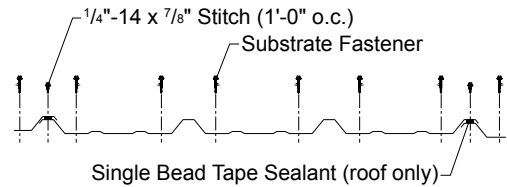

INSTALLATION STEPS

Note: It is recommended that ms-HT be installed under the valley flashing for added moisture protection.

1. If two or more valley flashings are required, the valley must be installed working from eave to peak. If two or more Valley Flashings are required, then they must be lapped a minimum of 6" with two continuous beads of Tube Sealant between them.
2. Do not install fasteners through the valley lap.
3. Place the Valley Flashing upside down at the eave of the building and mark the cut line for the valley angle. Cut the Valley flashing with Turbo-Shears starting from each side, working towards the center "V". Mark the center "V" as shown to allow extra material to cap off the end of the valley flashing. Cut with Turbo-Shears and Tin Snips. Bend the cut tabs in to close the V.
4. Apply a three-eighths inch bead of Tube Sealant along the Eave Flashings and place the Valley Flashing down.
5. Fasten the Valley Flashing to the roof deck with pancake head woodscrews four feet on center, on each side

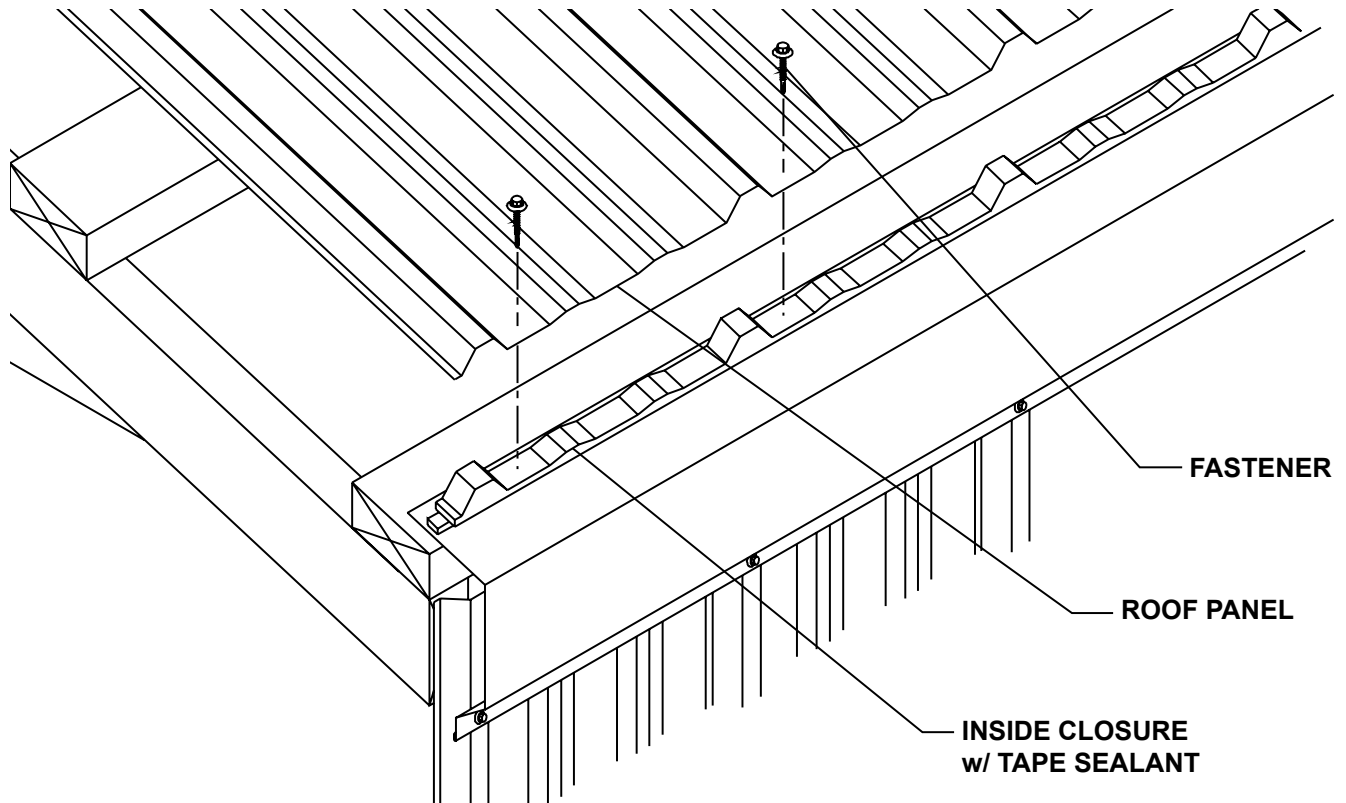

SUBSTRATE FASTENER INFORMATION

Open Framing

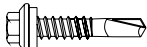

Self Driller
 #12-14 x 1"
 #12-14 x 1-1/2"
 #12-14 x 2"

Solid Wood Substrate



Woodscrew
 #10-14 x 1"
 #10-14 x 1-1/2"
 #10-14 x 2"

2X Wood Framing



Woodscrew
 #10-14 x 1"
 #10-14 x 1-1/2"
 #10-14 x 2"

PBR-PANEL END FASTENING PATTERN

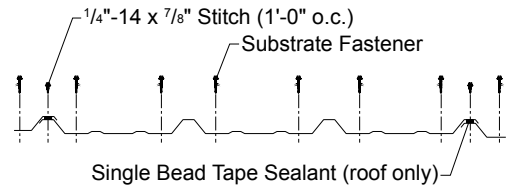

INSTALLATION STEPS

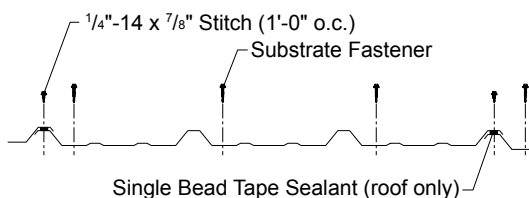

1. If your project has new or existing wall panels, you must consider adding additional overhang to your roof panels equal to the depth of the wall panels.
2. Turn the PBR Inside Closure over and attach Single Bead Tape Sealant to the underside. Place the PBR Inside Closure on top of the Eave Flashing. Install another row of Single Bead Tape Sealant to the top of the Inside Closure.
3. Make sure that the Inside Closure is square with the roof. Place the PBR-Panel over the Inside Closure.
4. The fastening pattern for roof panels at the panel ends, eave, gutter, ridge, or highside eave and at the endlap is as shown.
5. Fasteners at the ridge and highside eave are installed one inch from the end of the panels.
6. For certain building codes and state or county specifications, special fastener spacing may be required.
7. For the field of the panel the fastening pattern is as shown below.

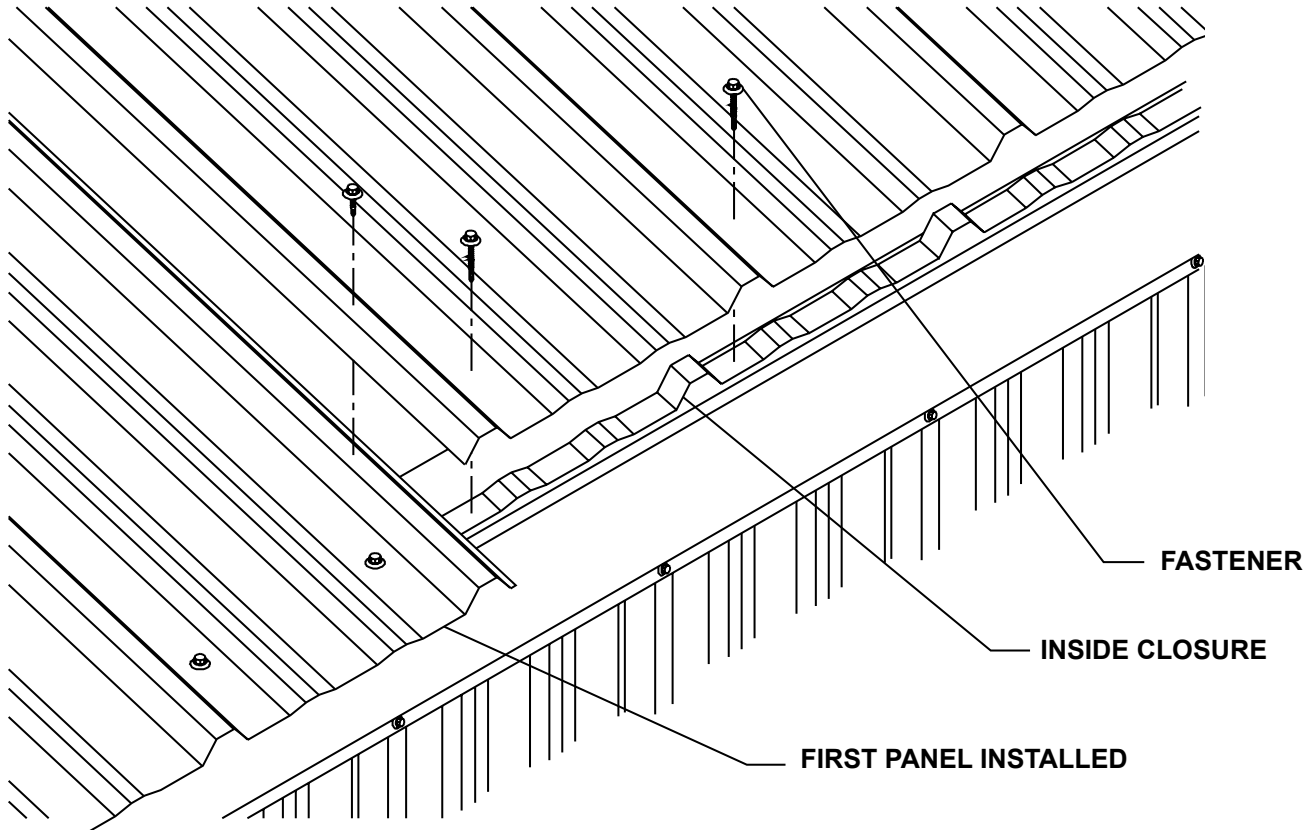

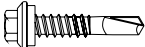

SUBSTRATE FASTENER INFORMATION

PBR-PANEL FASTENING PATTERN

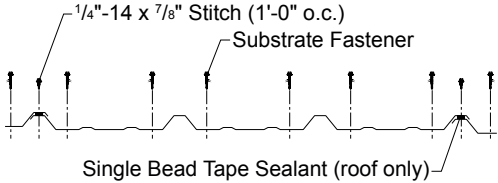
| | | | |
|--|---|--|--|
| <p>Open Framing</p>  <p>Self Driller #12-14 x 1" #12-14 x 1-1/2" #12-14 x 2"</p> | <p>Solid Wood Substrate</p>  <p>Woodscrew #10-14 x 1" #10-14 x 1-1/2" #10-14 x 2"</p> | <p>2X Wood Framing</p>  <p>Woodscrew #10-14 x 1" #10-14 x 1-1/2" #10-14 x 2"</p> |  <p>1/4"-14 x 7/8" Stitch (1'-0" o.c.) Substrate Fastener Single Bead Tape Sealant (roof only)</p> |
|--|---|--|--|

INSTALLATION STEPS

Note:

1. Before you install the next PBR-Panel, Single Bead Tape Sealant must be placed on the under lap rib of the previous panel.
2. Place the second panel on top of the previously installed panel covering the Single Bead Tape Sealant. Make sure that it is flush and square at the eave with the previous panel.
3. Install a Stitch Fastener on top of the lapping rib one foot on center through the sealant and the underlap rib.
4. Repeat this process for the remaining panels.
5. If you come to a valley condition, lay the panel down at the valley and mark the panel ribs to be cut. Snap a chalk line for the diagonal cut of the panel three inches from the center of the valley.
6. A Universal Closure is used instead of an Inside Closure at the valley condition.
7. Be sure to clean any debris or excess sealant before continuing the next section of the roof.

PBR-PANEL

ENDLAP INSTALLATION

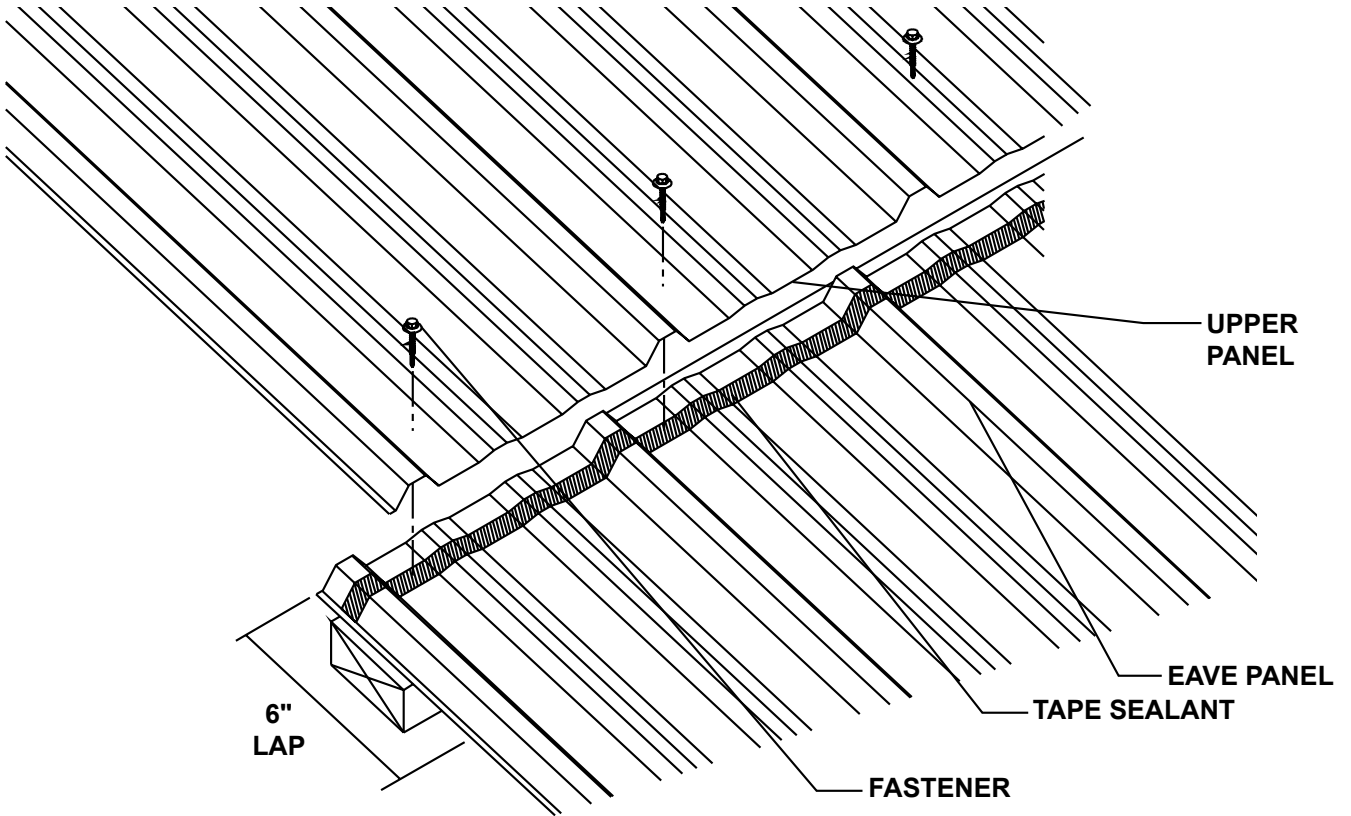

SUBSTRATE FASTENER INFORMATION

Open Framing

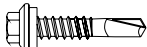

Self Driller
 #12-14 x 1"
 #12-14 x 1-1/2"
 #12-14 x 2"

Solid Wood Substrate



Woodscrew
 #10-14 x 1"
 #10-14 x 1-1/2"
 #10-14 x 2"

2X Wood Framing



Woodscrew
 #10-14 x 1"
 #10-14 x 1-1/2"
 #10-14 x 2"

PBR-PANEL FASTENING PATTERN

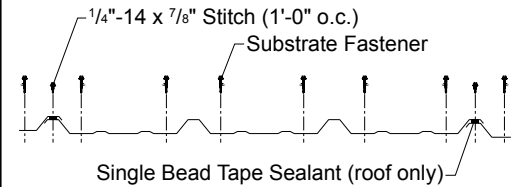

INSTALLATION STEPS

Note:

1. If more than one PBR Panel is required on a single panel run working eave to highside, then a panel endlap is required.
2. Start by installing all of the eave panels first. At the highside of the eave panels measure down three inches and apply a row of Single Bead Tape Sealant. Next apply another row of Single Bead Tape Sealant just above and below that first row.
3. Lap the highside panel over the eave panel a minimum of six inches.
4. Measure up the highside panel and install woodscrews with the correct fastening pattern so that the fastener goes through the middle row of the tape sealant and into the roof deck.

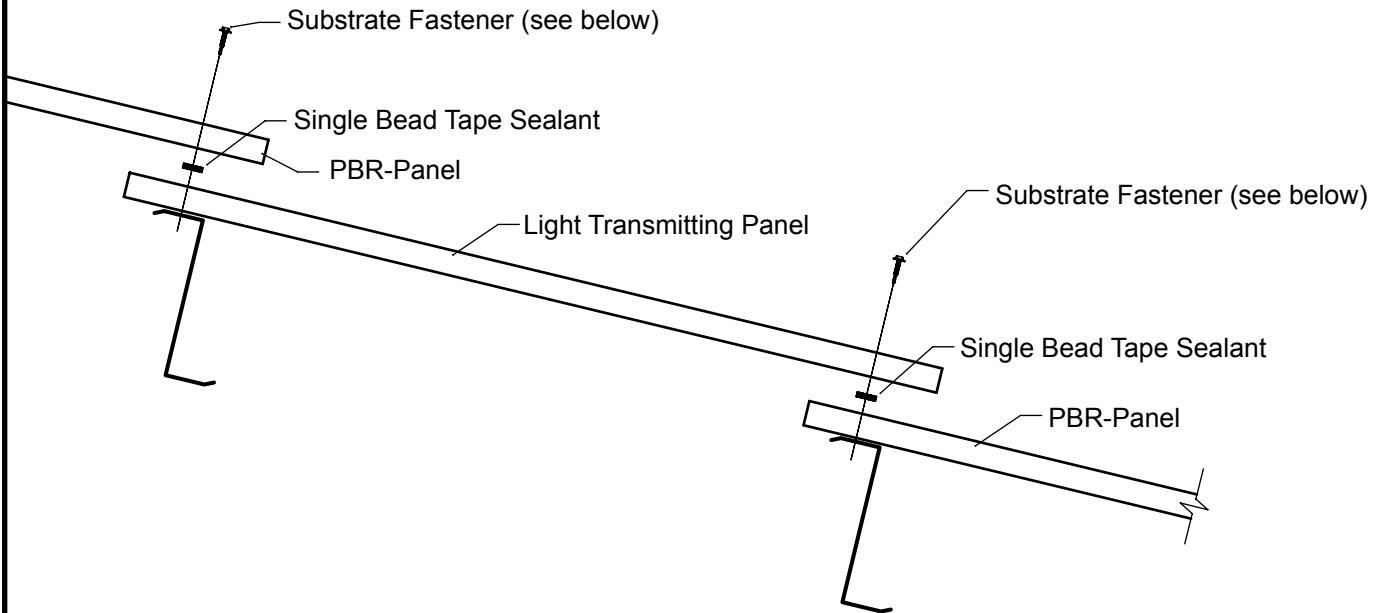

SUBSTRATE FASTENER INFORMATION

PBR-PANEL ENDLAP FASTENING PATTERN

Open Framing

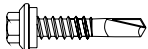

Self Driller
 #12-14 x 1"
 #12-14 x 1-1/2"
 #12-14 x 2"

Solid Wood Substrate



Woodscrew
 #10-14 x 1"
 #10-14 x 1-1/2"
 #10-14 x 2"

2X Wood Framing



Woodscrew
 #10-14 x 1"
 #10-14 x 1-1/2"
 #10-14 x 2"

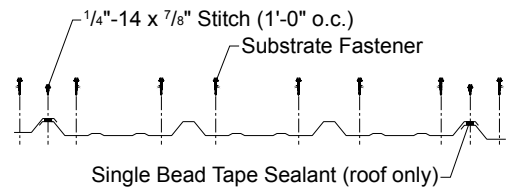

INSTALLATION STEPS

Note: Light Transmitting Panels require a minimum 6" lap at the low and high side of the panel.

1. Always install Light Transmitting Panels working from eave to ridge of the building for proper lapping.
2. After the Eave PBR-Panel is installed apply a row of Single bead Tape Sealant. Make sure that the Single Bead Tape Sealant is directly above your substrate member you are attaching to.
3. Place the low side of the Light Transmitting Panel over the Single Bead Tape Sealant.
4. Fasten the panels together with the substrate fastener, making sure the fastener goes through the middle of the Single Bead Tape Sealant and into the roof substrate member below.
5. Lap the highside panel over the Light Transmitting Panel a minimum of 6".
6. Measure up the highside panel and install woodscrews with the correct fastening pattern so that the fastener goes through the middle row of the Single Bead Tape Sealant and into the substrate member.

SAFETY NOTE: Never step, stand or walk on Light Transmitting Panels. They are not designed to carry point loading.

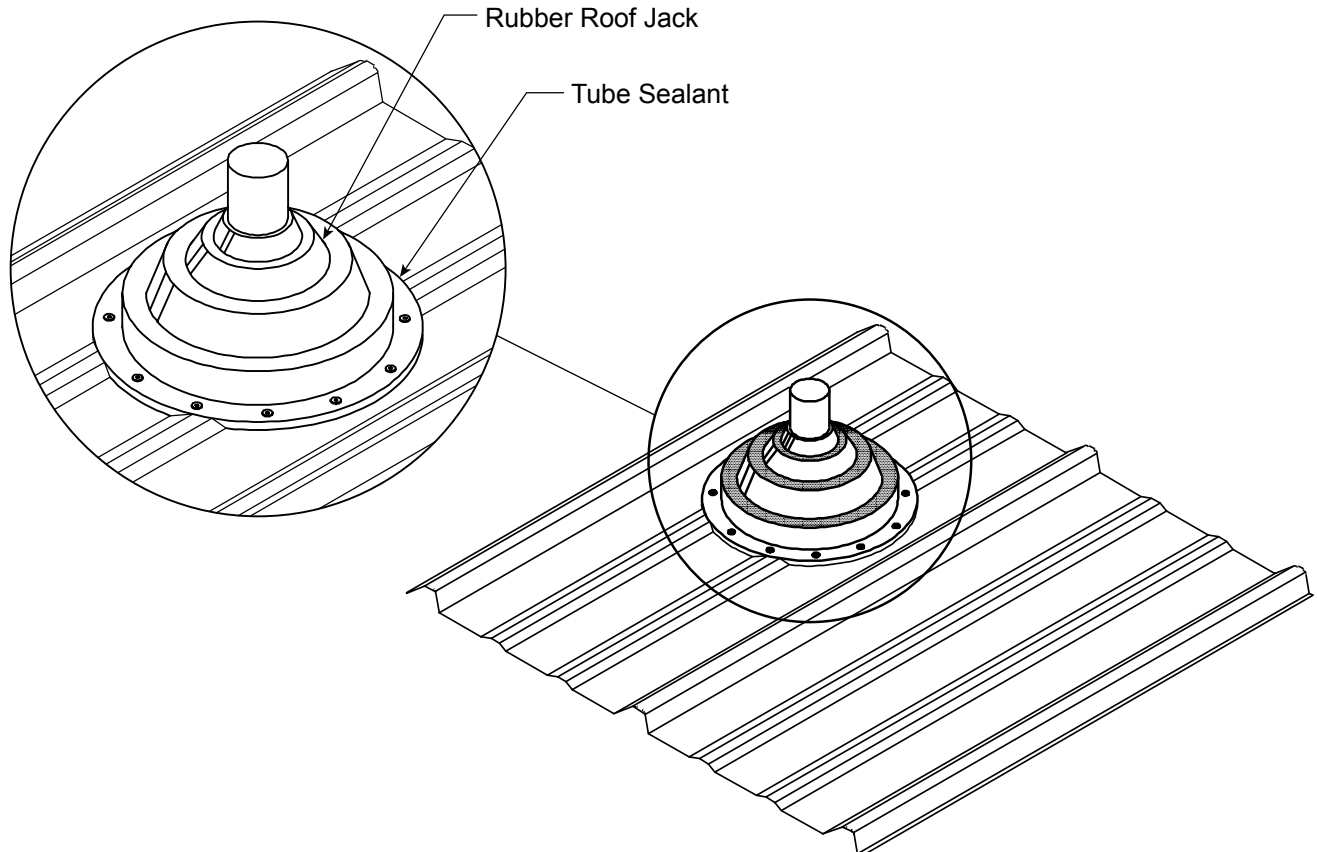

INSTALLATION STEPS

Note: Always abide by local plumbing codes when you're installing vent pipes

1. Areas around roof vents or rooftop units may show that corrosive fumes are emitted from a process within a building.
2. In the following example the procedures are for vent pipes six inches or less and not transmitting extremely hot or caustic materials.
3. The vent pipe must extend through the flat of the roof panel so that the Rubber Roof Jack does not block the flow of water. If the vent pipe extension cannot be raised directly into the minor ribs of the new roof panel, use elbows to offset the pipe.
4. Determine the size and length of the vent pipe to be raised.
5. Take the appropriate measurements for the pipe size and vent location, mark them on the PBR-Panel and cut the hole in the panel.
6. When cutting the hole in the panel for the penetration make the radius of the hole one half inch larger than the radius of the pipe. This will allow the panel to expand and contract around the penetration
7. Cut the top of the rubber roof jack so that it fits snug on the pipe. Slide the rubber roof jack onto the pipe all the way down until it is sitting on the roof panel.
8. If you are installing a square based rubber roof jack, make sure you turn it diamond shaped so the water runs around the side.
9. Lift the base of the rubber roof jack up so you can install tube sealant to the underside at the pipe.
10. Flip the rubber roof jack back down, flush with the panel
11. Bend up the base tabs of the rubber roof jack one side at a time and apply a bead of tube sealant. Repeat this with the other three sides of the rubber roof jack.
12. Attach the base of the rubber roof jack to the panel using stitch fasteners spaced 2" on center.
13. Apply tube sealant to the top of the rubber roof jack where it meets the pipe.

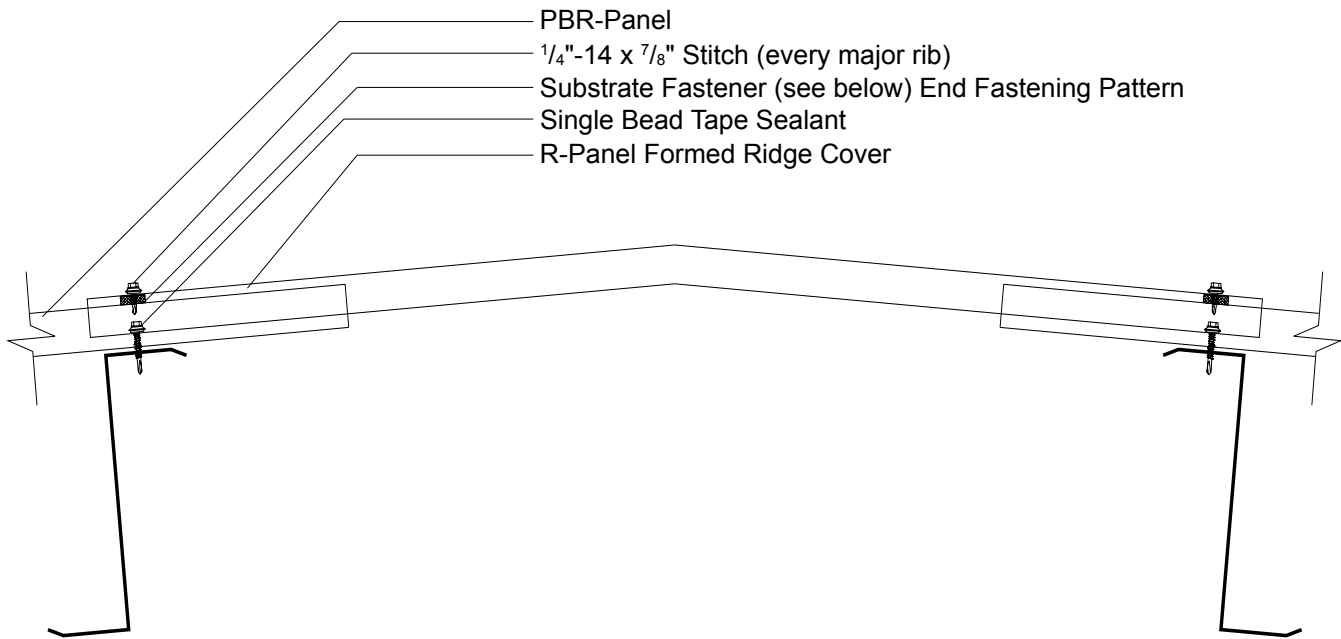

SUBSTRATE FASTENER INFORMATION

PBR-PANEL END FASTENING PATTERN

Open Framing

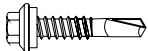

Self Driller
 #12-14 x 1"
 #12-14 x 1-1/2"
 #12-14 x 2"

Solid Wood Substrate

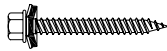

Woodscrew
 #10-14 x 1"
 #10-14 x 1-1/2"
 #10-14 x 2"

2X Wood Framing



Woodscrew
 #10-14 x 1"
 #10-14 x 1-1/2"
 #10-14 x 2"

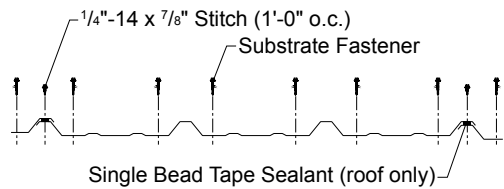

INSTALLATION STEPS

Note: It is critical that the panel ribs line up on both sides of the ridge before installing the Formed Ridge Flashing.

1. If you are using a Formed Ridge Flashing
2. If you using a Formed Ridge Condition then it should be installed before the Sculptured Rake.
3. Place the Formed Ridge Cover on top of the PBR roof panels at the ridge. Mark where the ridge flashing hits the PBR roof panels on both sides of the ridge.
4. Place a row of Single Bead Tape Sealant across the panel and over each panel rib on both sides of the ridge.
5. Fasten the Formed Ridge Flashing to the PBR roof panels with Woodscrew Fasteners, with the end fastening pattern.

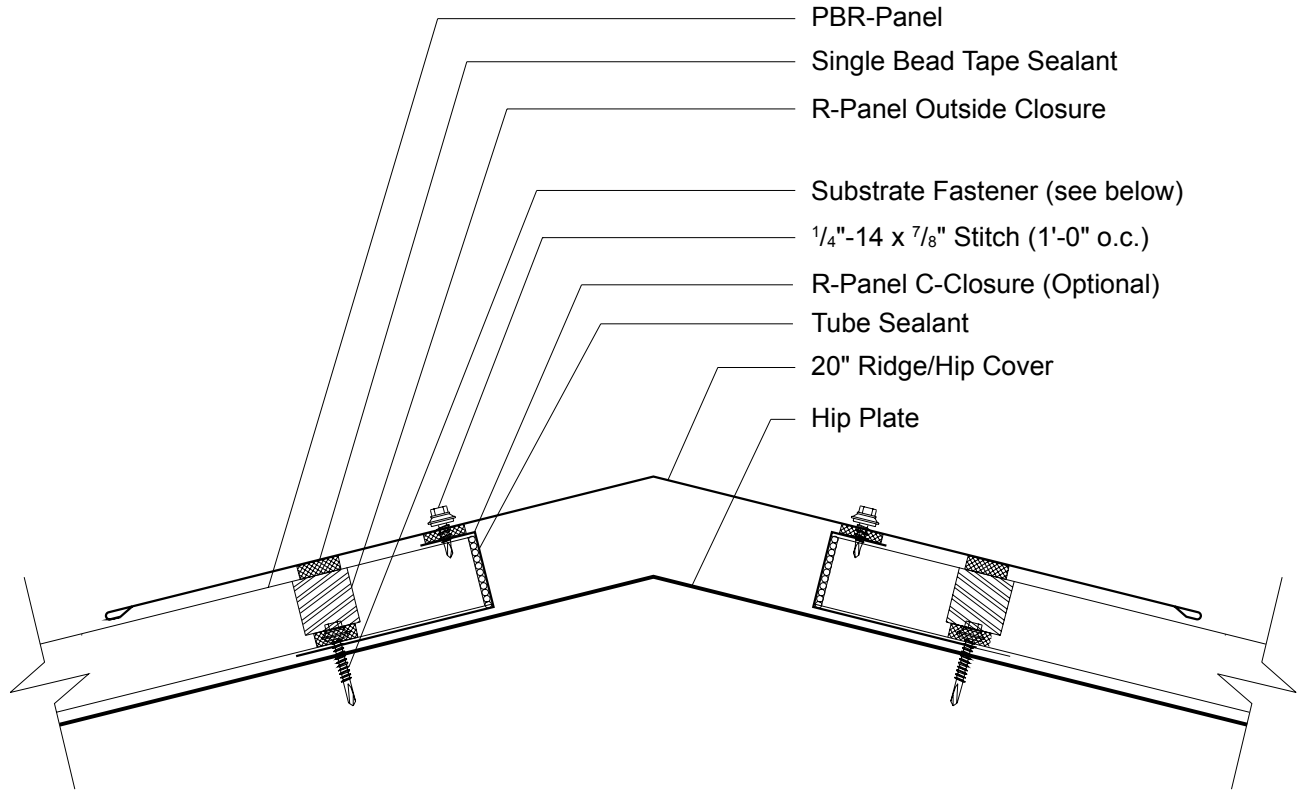

SUBSTRATE FASTENER INFORMATION

Open Framing

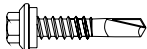

Self Driller
 #12-14 x 1"
 #12-14 x 1-1/2"
 #12-14 x 2"

Solid Wood Substrate



Woodscrew
 #10-14 x 1"
 #10-14 x 1-1/2"
 #10-14 x 2"

2X Wood Framing



Woodscrew
 #10-14 x 1"
 #10-14 x 1-1/2"
 #10-14 x 2"

PBR-PANEL END FASTENING PATTERN

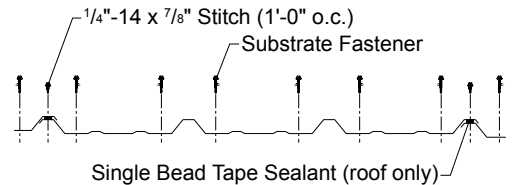

INSTALLATION STEPS

Note: C-Closure is optional on Hip installation.

1. Place the 20" Ridge/Hip Cover on top of the PBR roof panels. Mark where the edge of the Ridge/Hip Cover hits the PBR roof panels, upslope of your mark and downslope of the end fasteners, place a row of Single Bead Tape Sealant across the panel and over each panel rib.
2. Place PBR Outside Closures on top of the Single Bead Tape Sealant.
3. Apply a second row of Single Bead Tape Sealant to the top of the PBR Outside Closures.
4. Fasten the Ridge/Hip Cover to the PBR roof panels through the PBR Outside Closures with Stitch Fasteners, one at every major rib.
5. Now fasten the top of the Pitch Break Flashing to the wall or behind the wall panel.
6. If two or more flashings are required lap the flashing over the previously installed flashing by a minimum of two inches. Place a two beads of tube sealant between the flashings and secure with pop rivets two and a half inches on center.

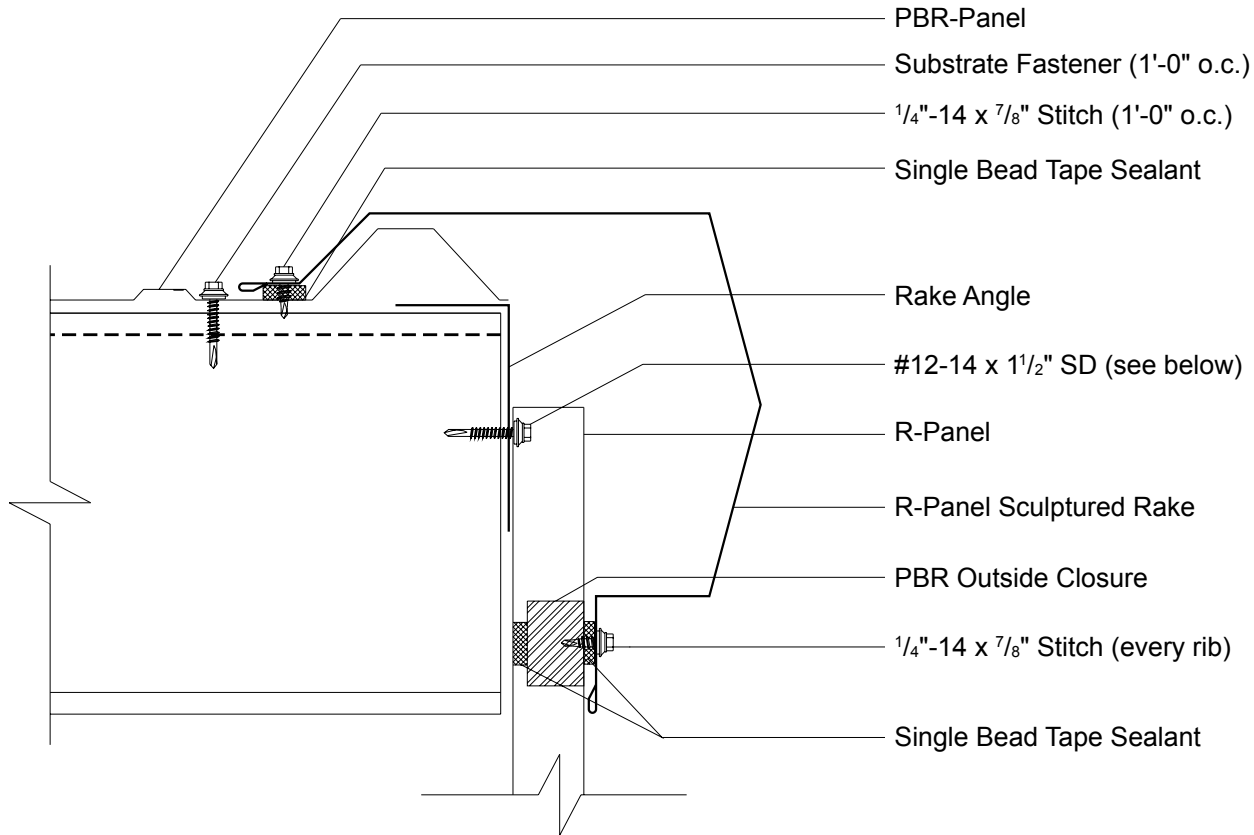

SUBSTRATE FASTENER INFORMATION

Open Framing

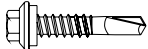

Self Driller
 #12-14 x 1"
 #12-14 x 1-1/2"
 #12-14 x 2"

Solid Wood Substrate



Woodscrew
 #10-14 x 1"
 #10-14 x 1-1/2"
 #10-14 x 2"

2X Wood Framing



Woodscrew
 #10-14 x 1"
 #10-14 x 1-1/2"
 #10-14 x 2"

INSTALLATION STEPS

1. Before installing the Sculptured Rake Flashing the Rake Ends will need to be installed.
2. Place the Rake Ends into the end of the Sculptured Rake Flashing and fasten with Pop Rivets.
3. Place the Sculptured Rake Flashing on the rake of the building and lightly mark where the bottom of the flashing hits the wall panel along the slope. Also mark where the edge of the Sculptured Rake rests on the roof panel.
4. Place a row of Single Bead Tape Sealant along the slope of the rake at the top of the wall panel so that it is behind the Sculptured Rake Flashing.
5. Apply a Universal Closure over the Single Bead Tape Sealant. Press firmly into place.
6. For slopes up to three to twelve a PBR Outside Closure can be used for PBR wall panels.
7. The Universal closure will act as a barrier to keep insects and debris from entering the building.
8. Apply a second row of Single Bead Tape Sealant to the face of the Universal Closure. Also apply a row of Single Bead Tape Sealant to the roof panels inside of the marks made.
9. Install the Sculptured Rake Flashing flush against the wall panels, making sure to hide the Universal Closure. Fasten through the closure to the wall panel with a Stitch Fastener at every major rib.
10. Fasten the Sculptured Rake Flashing to the PBR roof panel with a Stitch fastener 1'-0" o.c..

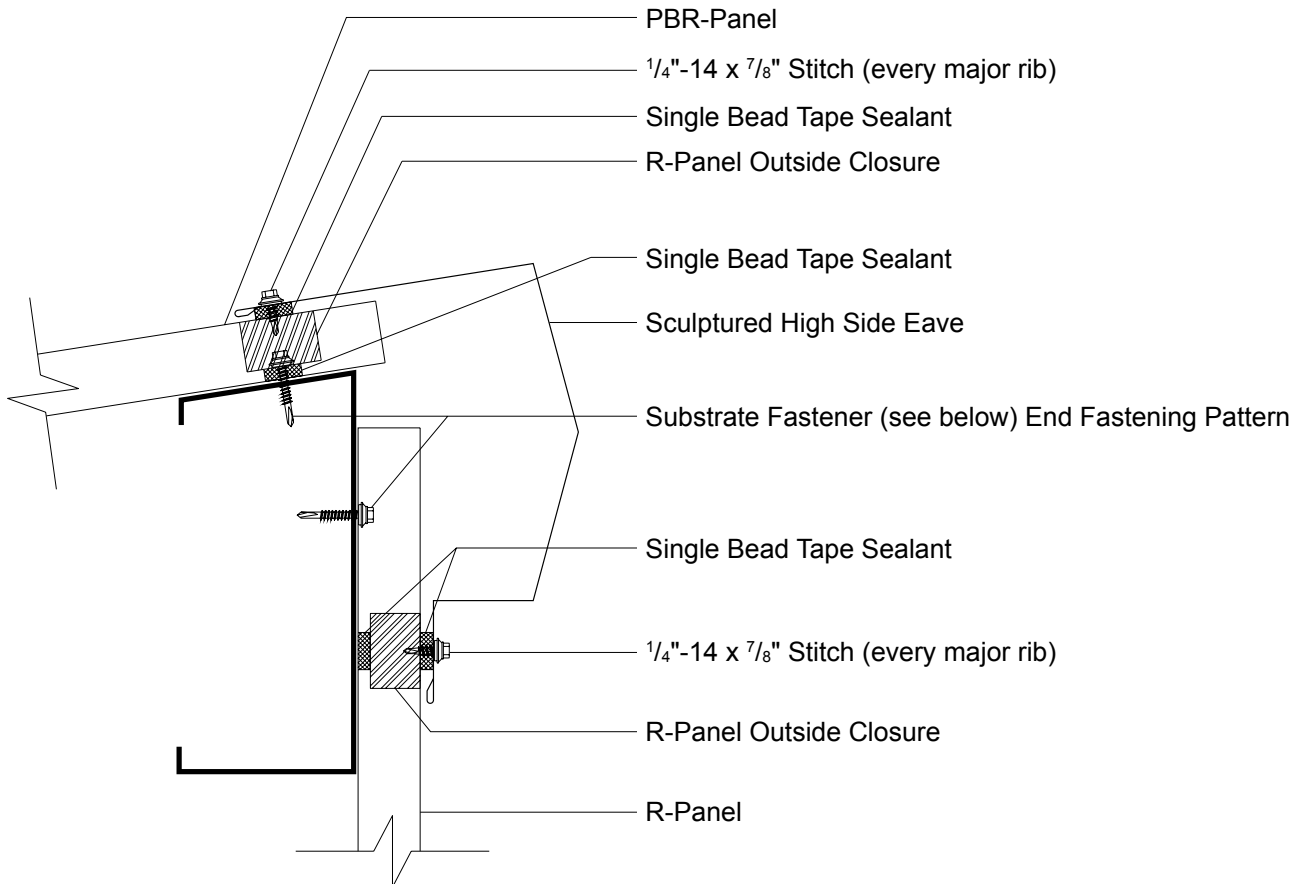

SUBSTRATE FASTENER INFORMATION

PBR-PANEL END FASTENING PATTERN

Open Framing

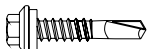

Self Driller
 #12-14 x 1"
 #12-14 x 1-1/2"
 #12-14 x 2"

Solid Wood Substrate



Woodscrew
 #10-14 x 1"
 #10-14 x 1-1/2"
 #10-14 x 2"

2X Wood Framing



Woodscrew
 #10-14 x 1"
 #10-14 x 1-1/2"
 #10-14 x 2"

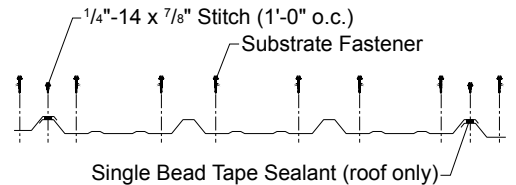

INSTALLATION STEPS

1. Place the Sculptured Highside Eave Flashing at the peak of the roof. Lightly mark where the bottom of the Sculptured Highside Eave Flashing meets the wall panel and the top edge hits the roof panel.
2. Place a row of Single Bead Tape Sealant across the roof panel and over each panel rib above the mark.
3. Place PBR Outside Closures along the length of the highside on the roof panels. Be sure the Outside Closures are located so that the Sculptured Highside Eave Flashing will cover them.
4. Apply a second row of Single Bead Tape Sealant to the top of the outside closures along the highside.
5. Now place a row of Single Bead Tape Sealant along the top of the wall panel so that it is above the wall mark.
6. Place the Outside Closures or a Universal Closure over the Single Bead Tape Sealant. The Outside Closure or Universal Closure will act as a barrier to keep insects and debris from entering the building.
7. Apply a second row of Single Bead Tape Sealant to the top of the Outside Closures along the at the wall.
8. Place Sculptured Highside Eave Flashing flush against the roof and wall panels.
9. Fasten the Sculptured Highside Eave Flashing to the PBR roof panel through the PBR Outside Closures with Stitch Fasteners, one at every major rib.
10. Now fasten the Sculptured Highside Eave Flashing to the wall with Stitch Fasteners at every major rib.

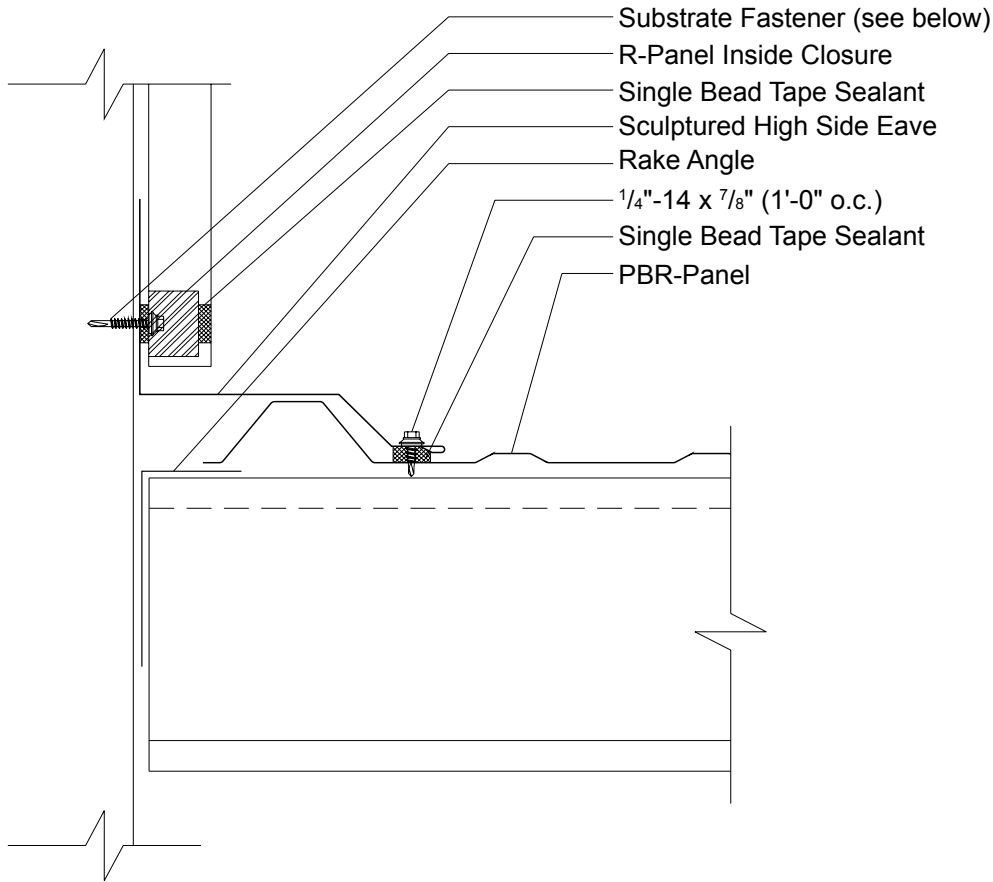

SUBSTRATE FASTENER INFORMATION

Open Framing

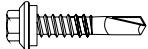

Self Driller
 #12-14 x 1"
 #12-14 x 1-1/2"
 #12-14 x 2"

Solid Wood Substrate



Woodscrew
 #10-14 x 1"
 #10-14 x 1-1/2"
 #10-14 x 2"

2X Wood Framing



Woodscrew
 #10-14 x 1"
 #10-14 x 1-1/2"
 #10-14 x 2"

INSTALLATION STEPS

1. Place the Rakewall Flashing up against the wall and resting on the roof panel. Lightly mark the edge of the flashing on the roof panel.
2. Apply a row of Single Bead Tape Sealant on the major rib of the roof panel down the slope.
3. Lay the Rakewall Flashing down and fasten it to the PBR roof panel with a Stitch fastener one foot on center.
4. Now fasten the top of the Rakewall Flashing to the wall.
5. Install the counter flashing, reglet or wall panel and fasten to the parapet wall with the appropriate fastener one foot on center. If counter flashing or reglet is used, seal it to parapet wall with tube sealant.

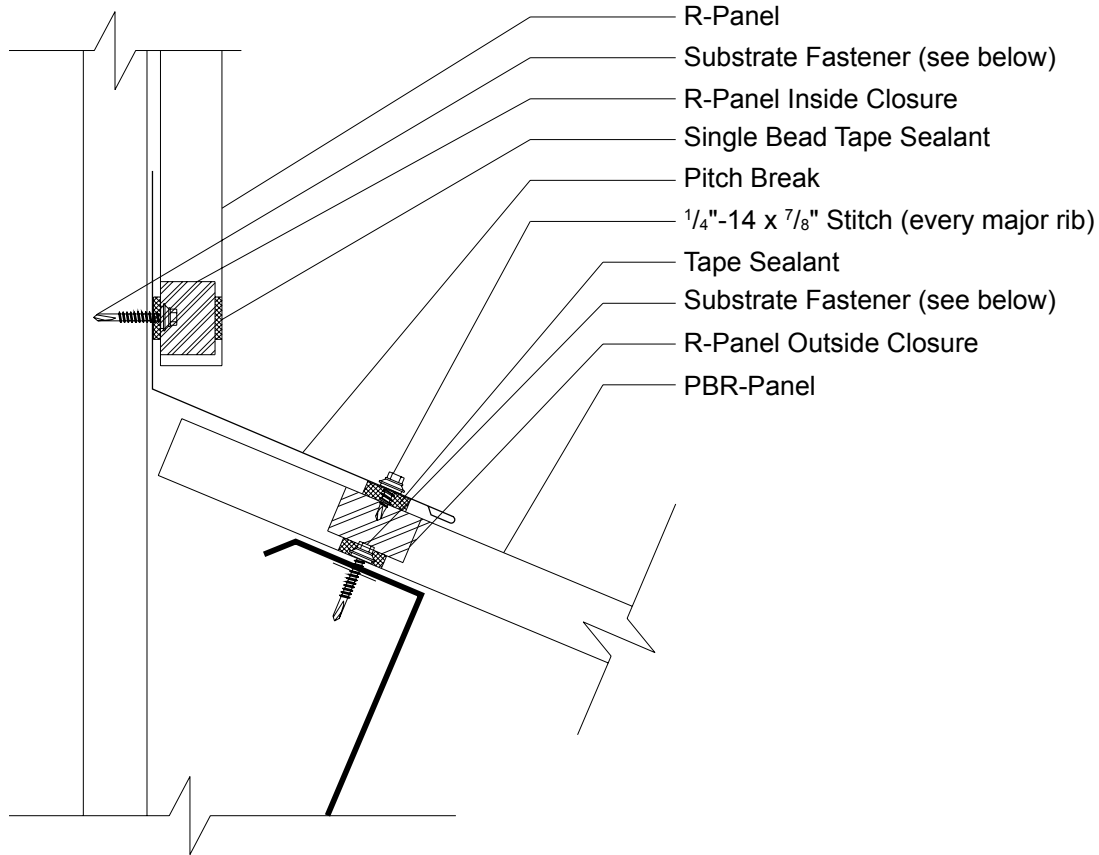

SUBSTRATE FASTENER INFORMATION

Open Framing

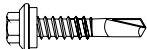

Self Driller
 #12-14 x 1"
 #12-14 x 1-1/2"
 #12-14 x 2"

Solid Wood Substrate



Woodscrew
 #10-14 x 1"
 #10-14 x 1-1/2"
 #10-14 x 2"

2X Wood Framing



Woodscrew
 #10-14 x 1"
 #10-14 x 1-1/2"
 #10-14 x 2"

PBR-PANEL END FASTENING PATTERN

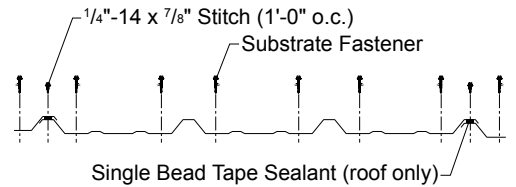

INSTALLATION STEPS

1. Place the Pitch Break Flashing on top of the PBR roof panels. Mark where the edge of the Pitch Break Flashing hits the PBR roof panels, upslope of your mark and downslope of the end fasteners, place a row of Single Bead Tape Sealant across the panel and over each panel rib.
2. Place PBR Outside Closures on top of the Single Bead Tape Sealant.
3. Apply a second row of Single Bead Tape Sealant to the top of the PBR Outside Closures.
4. Fasten the Pitch Break Flashing to the PBR roof panels through the PBR Outside Closures with Stitch Fasteners, one at every major rib.
5. Now fasten the top of the Pitch Break Flashing to the wall or behind the wall panel.
6. Install the counter flashing, reglet or wall panel and fasten to the parapet wall with the appropriate fastener one foot on center. If counter flashing or reglet is used, seal it to parapet wall with tube sealant.
7. If two or more flashings are required lap the flashing over the previously installed flashing by a minimum of two inches. Place a two beads of tube sealant between the flashings and secure with pop rivets two and a half inches on center.

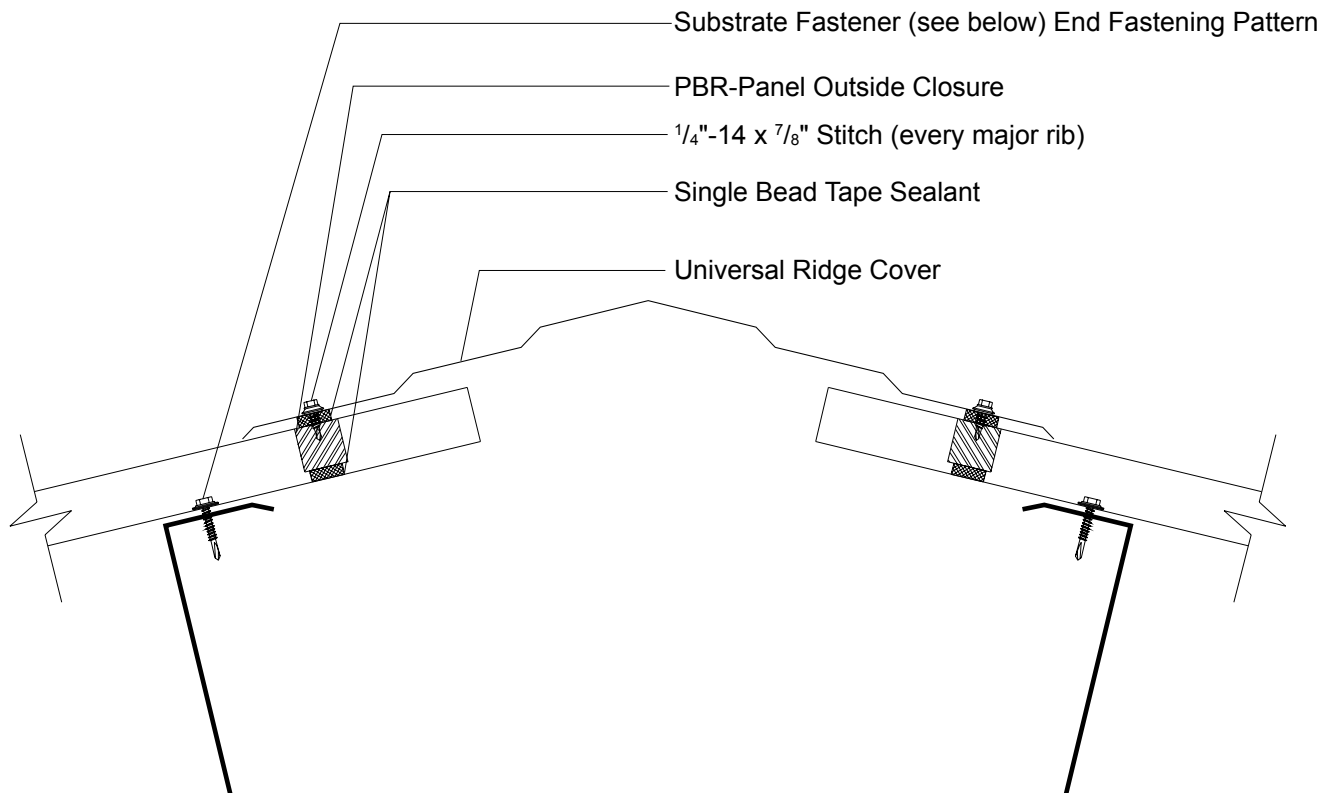

SUBSTRATE FASTENER INFORMATION

PBR-PANEL END FASTENING PATTERN

Open Framing

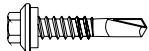

Self Driller
 #12-14 x 1"
 #12-14 x 1-1/2"
 #12-14 x 2"

Solid Wood Substrate

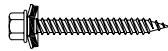

Woodscrew
 #10-14 x 1"
 #10-14 x 1-1/2"
 #10-14 x 2"

2X Wood Framing

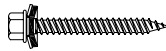

Woodscrew
 #10-14 x 1"
 #10-14 x 1-1/2"
 #10-14 x 2"

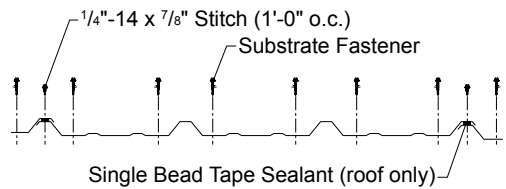

INSTALLATION STEPS

1. Place the Universal Ridge Cover on top of the PBR roof panels. Mark the edge location of both sides of the Universal Ridge Flashing. Place a row of Single Bead Tape Sealant two inches up from your mark, across the panel and over each panel rib on both sides of the ridge.
2. Place PBR Outside Closures on top of the outside closures along the length of the ridge.
3. Apply a second row of Single Bead Tape Sealant to the top of the PBR Outside Closures.
4. Place the Universal Ridge Flashing down on the ridge and fasten the Universal Ridge Flashing to the PBR-Panels through the PBR Outside Closures with Stitch Fasteners, one at every major rib.
5. If two or more flashings are required lap the flashing over the previously installed flashing by a minimum of two inches. Place a two beads of tube sealant between the flashings and secure with pop rivets two and a half inches on center.

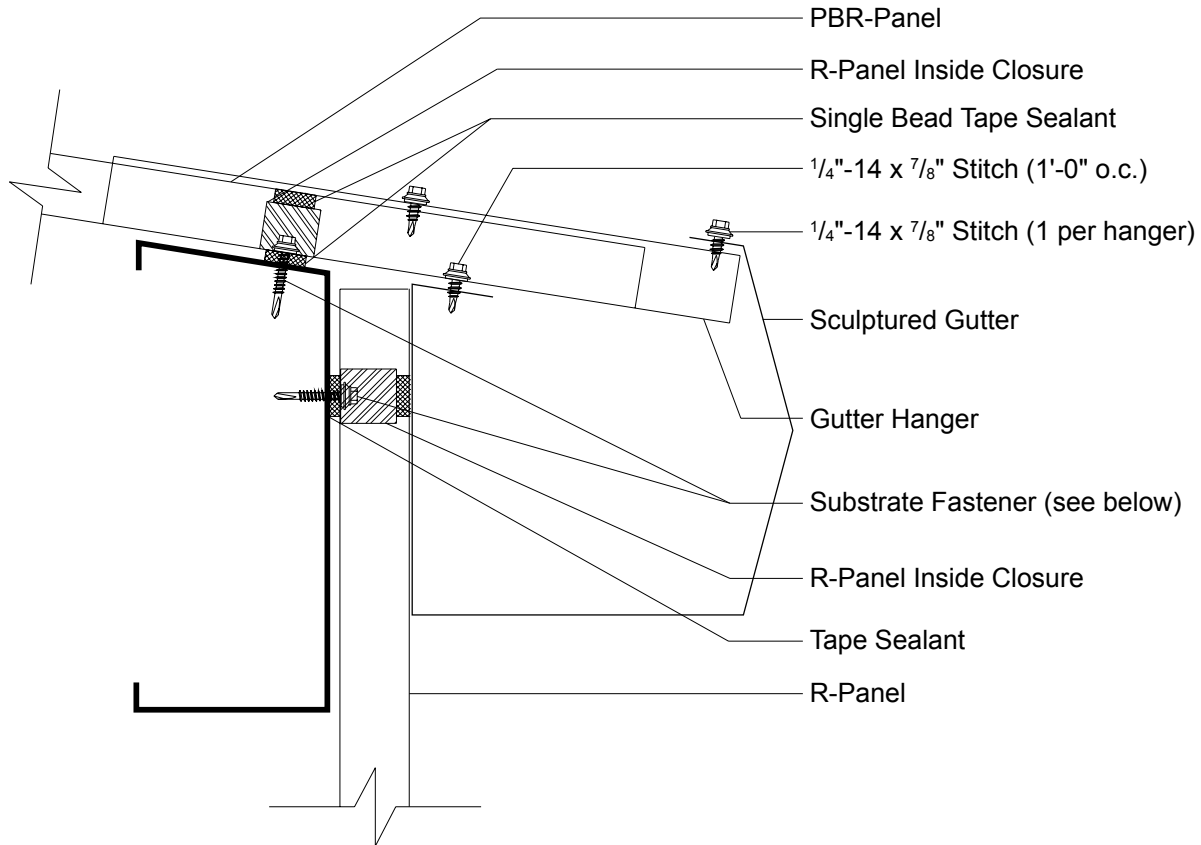

SUBSTRATE FASTENER INFORMATION

Open Framing

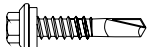

Self Driller
 #12-14 x 1"
 #12-14 x 1-1/2"
 #12-14 x 2"

Solid Wood Substrate



Woodscrew
 #10-14 x 1"
 #10-14 x 1-1/2"
 #10-14 x 2"

2X Wood Framing



Woodscrew
 #10-14 x 1"
 #10-14 x 1-1/2"
 #10-14 x 2"

PBR-PANEL END FASTENING PATTERN

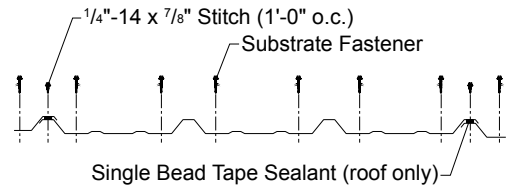

INSTALLATION STEPS

1. install the Gutter Hangers. They need to be spaced at no greater than three feet on center along the gutter line.
2. Hold the Sculptured Gutter in place flush against the Eave Flashing. Set the Gutter Hanger on top of the major rib of the PBR roof panel and slide the Gutter Hanger into the front of the gutter. Lightly mark on the panel the end of the gutter hanger. Measure and install the other Gutter Hangers down the length of the Gutter.
3. Apply Single Bead Tape Sealant to the top of the ribs. Place the Gutter Hangers as marked and fasten the Gutter Hanger to the major rib of the panel with two Stitch Fasteners.
4. Once all of the Gutter Hangers are in place install the Sculptured Gutter flashing back against the Eave Flashing.
5. Fasten the back of the Sculptured Gutter flashing to the end of the roof panel with Stitch Fasteners at a maximum of one foot on center.
6. Now fasten the front of the Sculptured Gutter to the Gutter Hangers with Stitch Fasteners. One fastener per Gutter Hanger.
7. Always remember the size and gauge of the Sculptured Gutter should be designed to applicable governing building codes.

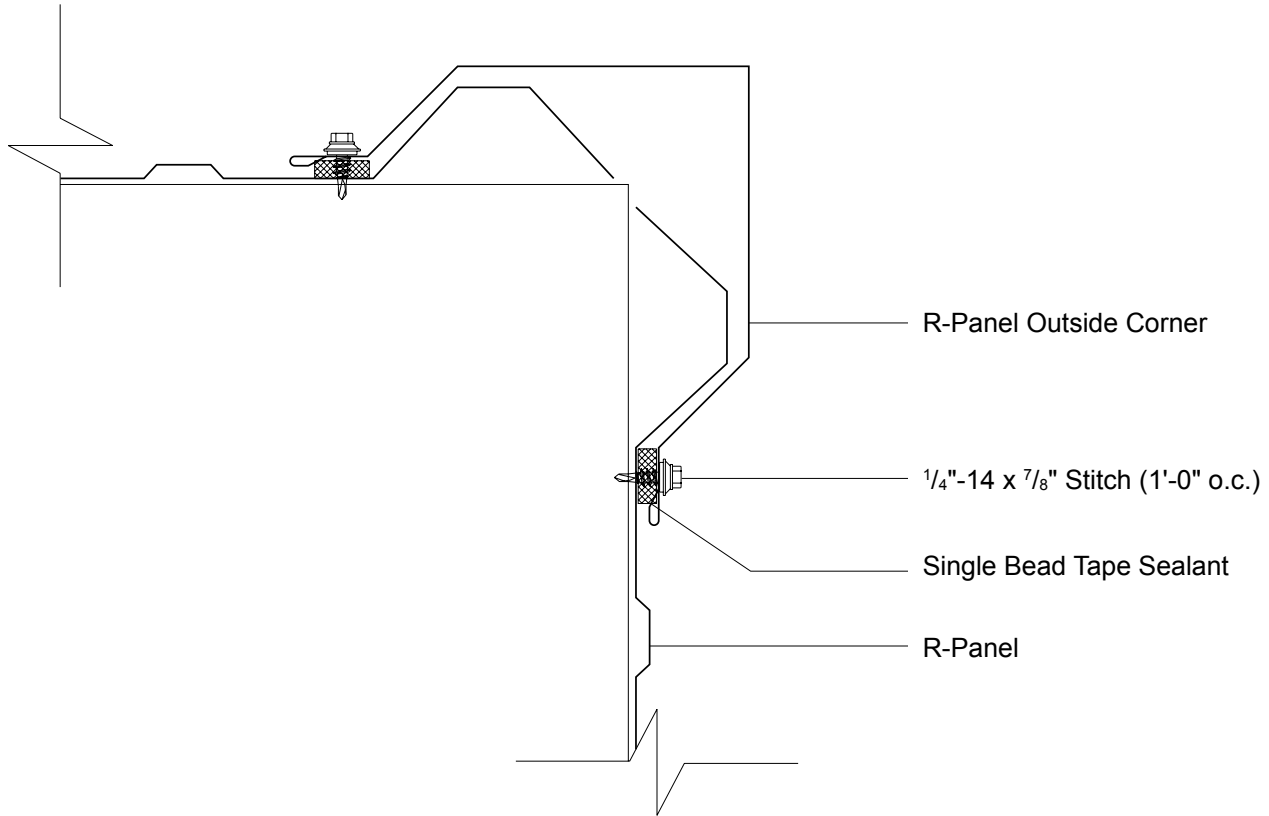

SUBSTRATE FASTENER INFORMATION

OPTIONAL FLASHING

Open Framing

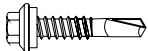

Self Driller
 #12-14 x 1"
 #12-14 x 1-1/2"
 #12-14 x 2"

Solid Wood Substrate

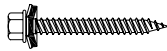

Woodscrew
 #10-14 x 1"
 #10-14 x 1-1/2"
 #10-14 x 2"

2X Wood Framing



Woodscrew
 #10-14 x 1"
 #10-14 x 1-1/2"
 #10-14 x 2"

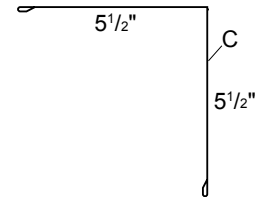

INSTALLATION STEPS

Note: Outside Corner Flashings should be installed working from the ground up.

1. After the PBR wall panel is installed place the first Outside Corner Flashing at the base of the building.
2. Install a row of Single Bead Tape Sealant on each side of the Outside Corner Flashing.
3. Place the Outside Corner Flashing on the wall panels.
4. Fasten to the wall panels with 1/4"-14 x 7/8" Stitch Fasteners, 1'-0" on center.
5. If more than one Outside Corner Flashing is needed then a flashing lap is required.
6. Apply two rows of Tube Sealant to the top of the installed Outside Corner Flashing.
7. Lap the flashings a minimum of 3" and fasten with Pop Rivets 2" on center.

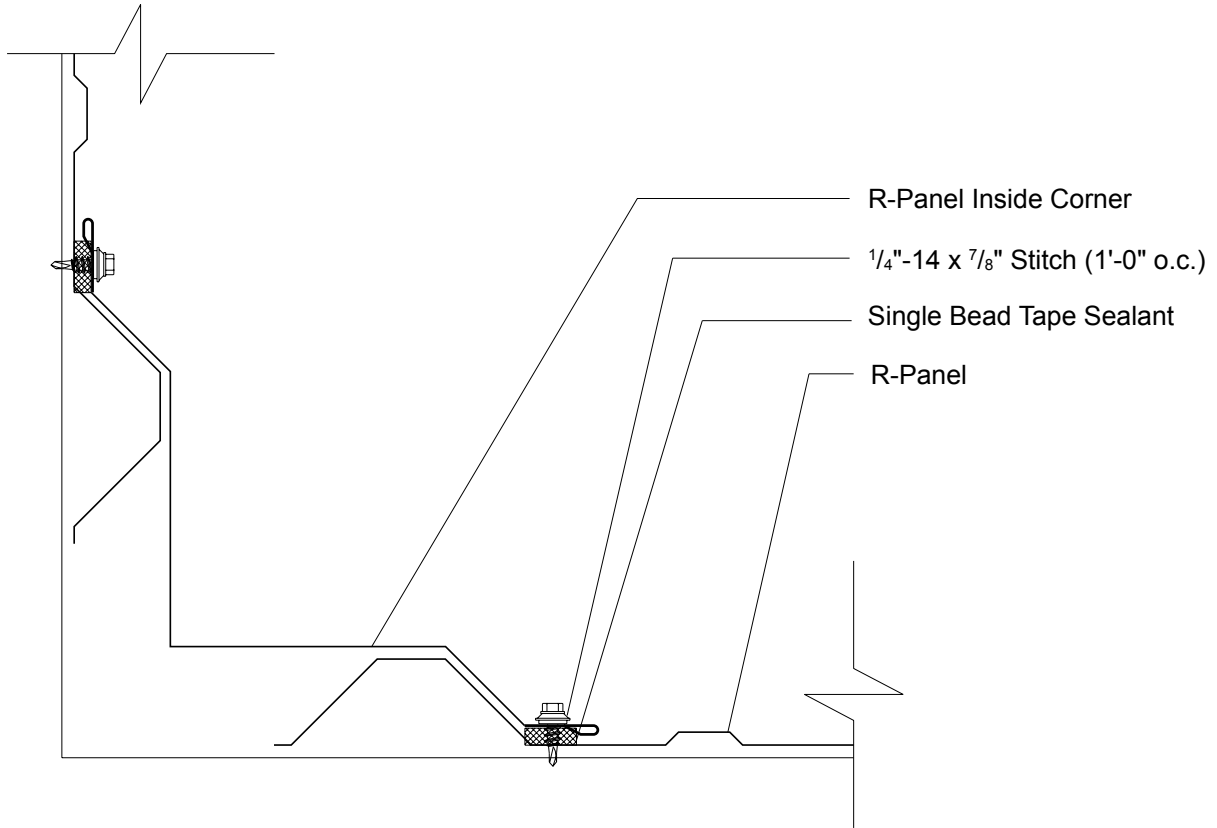

SUBSTRATE FASTENER INFORMATION

OPTIONAL FLASHING

Open Framing

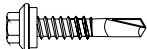

Self Driller
 #12-14 x 1"
 #12-14 x 1-1/2"
 #12-14 x 2"

Solid Wood Substrate



Woodscrew
 #10-14 x 1"
 #10-14 x 1-1/2"
 #10-14 x 2"

2X Wood Framing



Woodscrew
 #10-14 x 1"
 #10-14 x 1-1/2"
 #10-14 x 2"

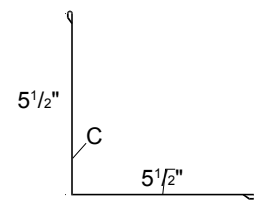

INSTALLATION STEPS

Note: Inside Corner Flashings should be installed working from the ground up.

1. After the PBR wall panel is installed place the first Inside Corner Flashing at the base of the building.
2. Install a row of Single Bead Tape Sealant on each side of the Inside Corner Flashing.
3. Place the Inside Corner Flashing on the wall panels.
4. Fasten to the wall panels with 1/4"-14 x 7/8" Stitch Fasteners, 1'-0" on center.
5. If more than one Inside Corner Flashing is needed then a flashing lap is required.
6. Apply two rows of Tube Sealant to the top of the installed Inside Corner Flashing.
7. Lap the flashings a minimum of 3" and fasten with Pop Rivets 2" on center.

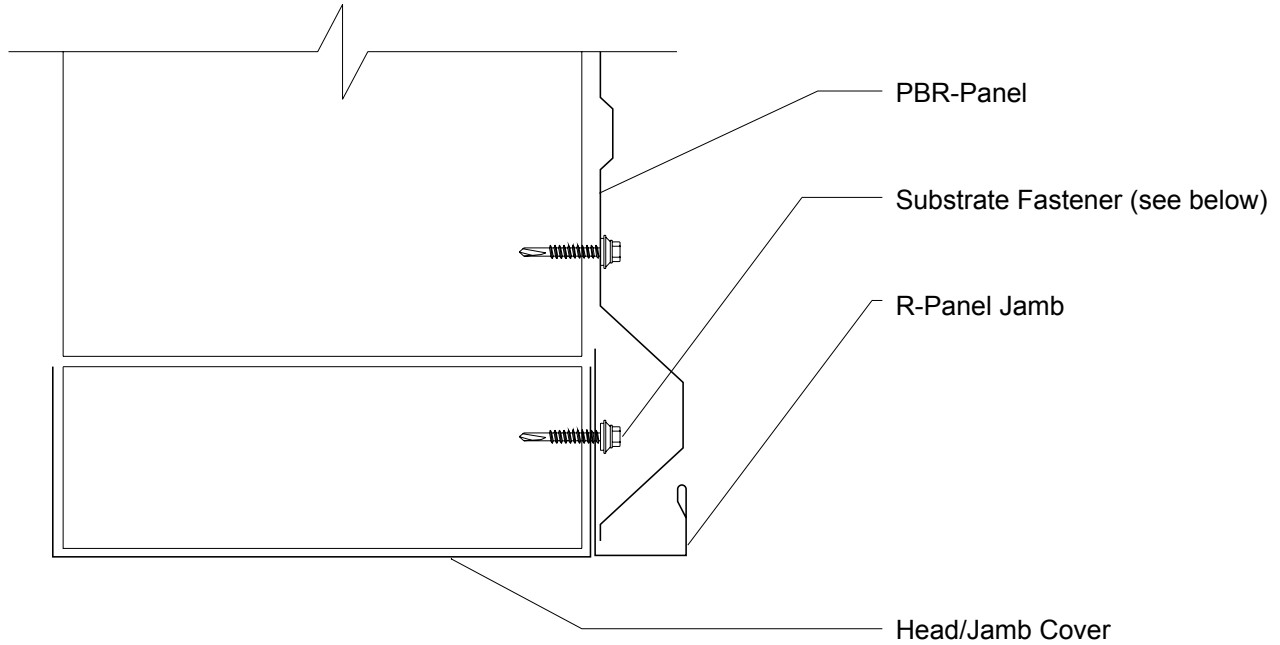

SUBSTRATE FASTENER INFORMATION

Open Framing

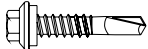

Self Driller
 #12-14 x 1"
 #12-14 x 1-1/2"
 #12-14 x 2"

Solid Wood Substrate



Woodscrew
 #10-14 x 1"
 #10-14 x 1-1/2"
 #10-14 x 2"

2X Wood Framing



Woodscrew
 #10-14 x 1"
 #10-14 x 1-1/2"
 #10-14 x 2"

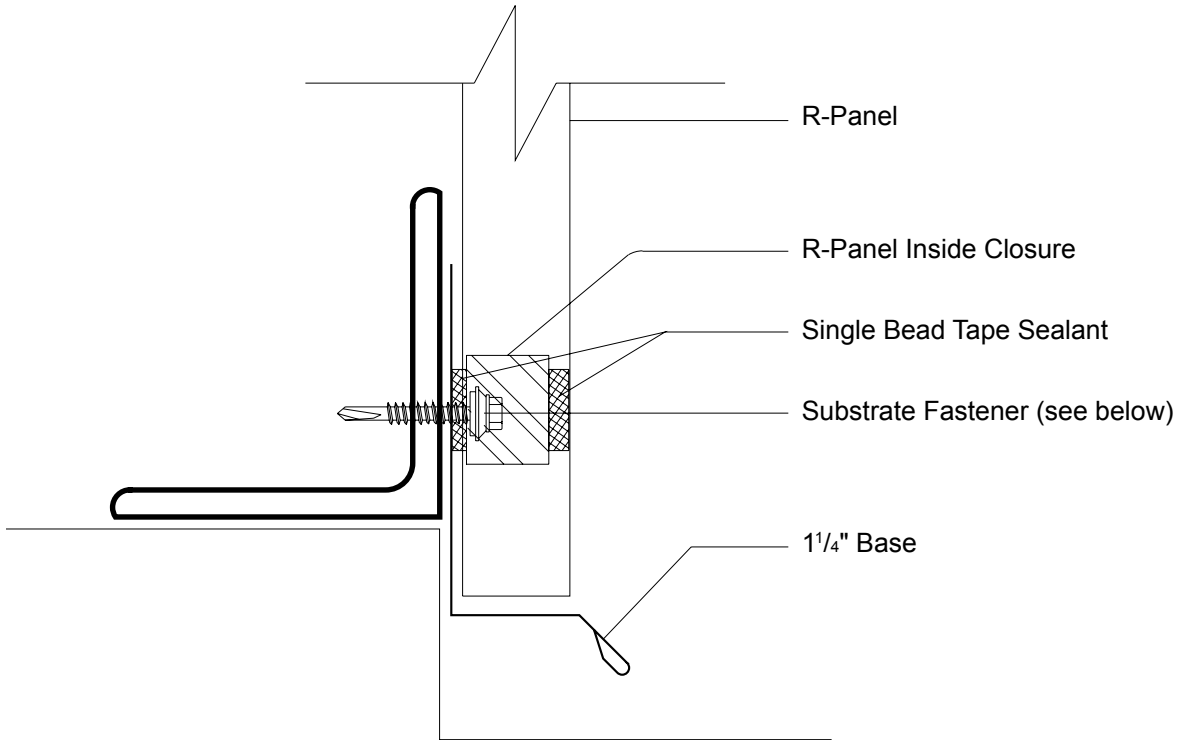

SUBSTRATE FASTENER INFORMATION

PBR-PANEL FASTENING PATTERN

Open Framing

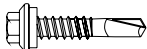

Self Driller
 #12-14 x 1"
 #12-14 x 1-1/2"
 #12-14 x 2"

Solid Wood Substrate

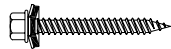

Woodscrew
 #10-14 x 1"
 #10-14 x 1-1/2"
 #10-14 x 2"

2X Wood Framing



Woodscrew
 #10-14 x 1"
 #10-14 x 1-1/2"
 #10-14 x 2"

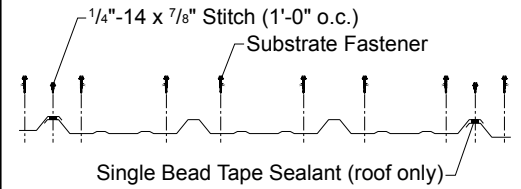

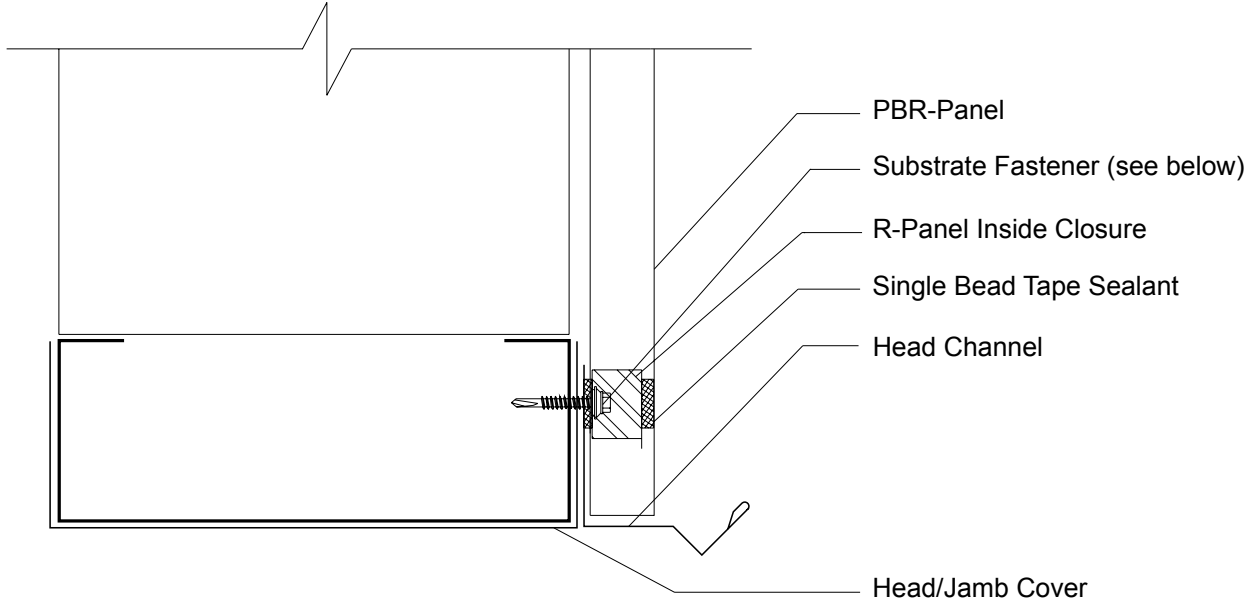

SUBSTRATE FASTENER INFORMATION

PBR-PANEL FASTENING PATTERN

Open Framing

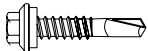

Self Driller
 #12-14 x 1"
 #12-14 x 1-1/2"
 #12-14 x 2"

Solid Wood Substrate

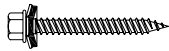

Woodscrew
 #10-14 x 1"
 #10-14 x 1-1/2"
 #10-14 x 2"

2X Wood Framing



Woodscrew
 #10-14 x 1"
 #10-14 x 1-1/2"
 #10-14 x 2"

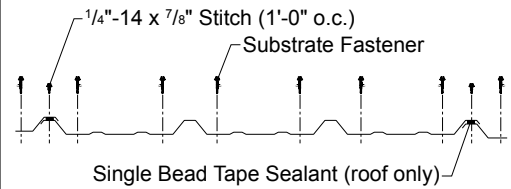

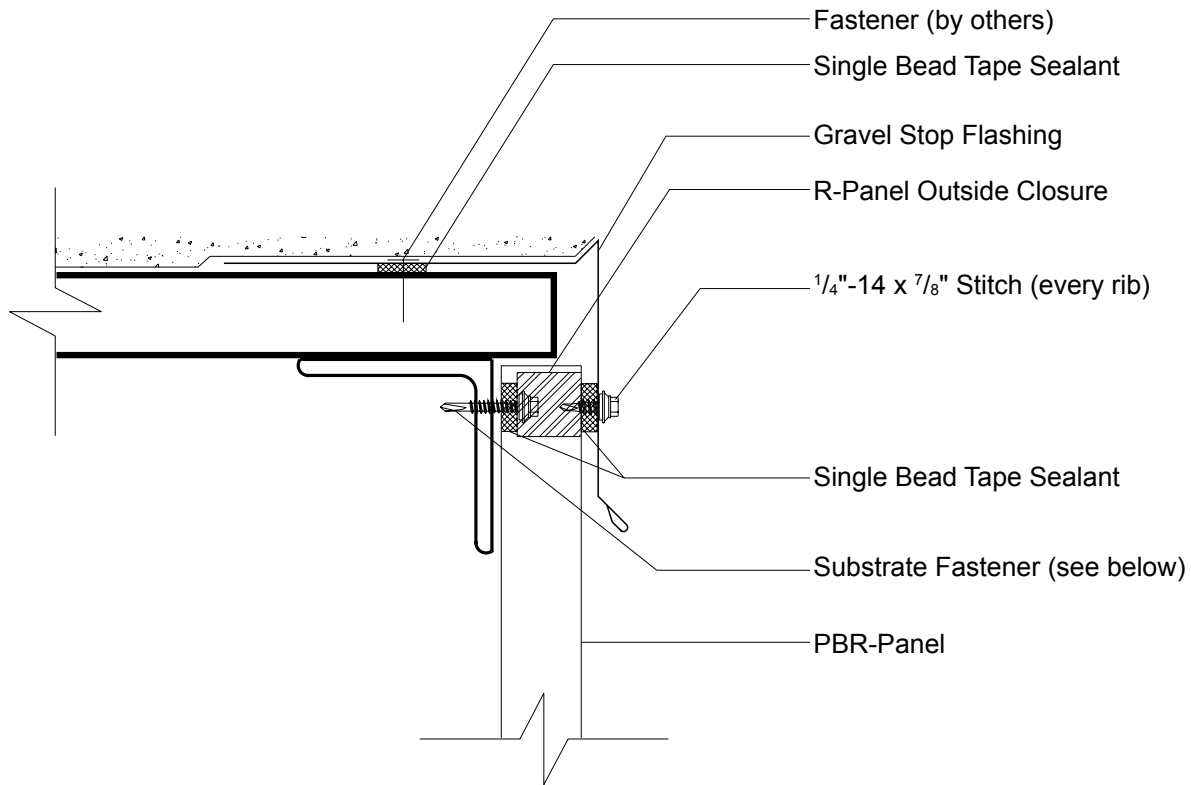

SUBSTRATE FASTENER INFORMATION

PBR-PANEL FASTENING PATTERN

Open Framing

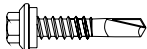

Self Driller
 #12-14 x 1"
 #12-14 x 1-1/2"
 #12-14 x 2"

Solid Wood Substrate



Woodscrew
 #10-14 x 1"
 #10-14 x 1-1/2"
 #10-14 x 2"

2X Wood Framing



Woodscrew
 #10-14 x 1"
 #10-14 x 1-1/2"
 #10-14 x 2"

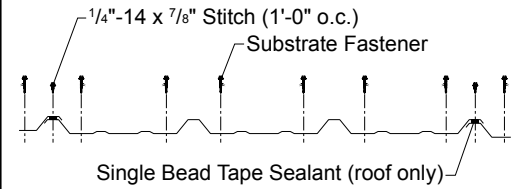

ZAC™ Self Drillers

[COMPONENTS](#) / [FASTENERS](#) / [METAL TO METAL SCREWS](#) / [ZAC™ SELF DRILLERS](#)

EMF's premium line of self-drilling fasteners, the ZAC™ Self Driller hex head is a strong, uniform zinc cap that withstands the toughest installation conditions and comes with a limited lifetime warranty for superior corrosion protection on the head of the fastener. Features include a thick EPDM seal washer, galvanized shank plating and a precision-forged self-drilling point for metal-to-metal applications up to 8-gauge steel. 5/16" or 3/8" head style/size depending on drill point size. Also available painted to match panel colors.



#12-14 Self Driller 3

Head Style Size: 5/16" Hex
Point: SD3
Washer: Thick EPDM Seal Washer
Sizes: 1", 1-1/4" 1-1/2", 2", 2-1/2", 3"
Other: Drill & Tap up to .035 – .210"



#12-24 Self Driller 5

Head Style Size: 3/8" Hex
Point: SD5
Washer: Thick EPDM Seal Washer
Sizes: 1-1/2"
Other: Drill and Tap up to 1/2"



#14 ZAC Tapper Replacement

Head Style Size: 5/16" Hex
Point: SD2/SD3
Washer: Thick EPDM Seal Washer
Sizes: 1-1/2", 1-1/4"
Other: Drill & Tap up to .050 – .210"



1/4-14 Stitch Self Driller 1

Head Style Size: 3/8" or 5/16" Hex
Point: SD1
Washer: Thick EPDM Seal Washer
Sizes: 7/8"
Other: Tap up to .030" – .095"



1/4-14 Self Driller 2

Head Style Size: 5/16" AFH Hex
Point: SD2
Washer: Thick EPDM Seal Washer
Sizes: 1-1/2"
Other: Drill & Tap up to .050 – .150"

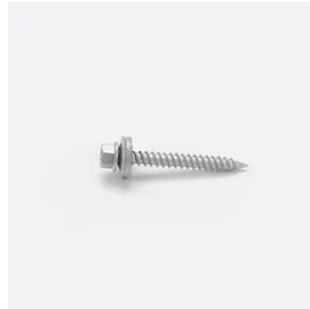

1/4-14 Self Driller 3

Head Style Size: 5/16" HWH
Point: SD3
Washer: Thick EPDM Seal Washer
Sizes: 1-1/4"
Other: Drill and Tap Up to .050-.210"



[Request Quote](#)

[HOME](#)

[ABOUT](#)

[METAL PANELS](#)

[COMPONENTS](#)

[RESOURCES](#)

[GALLERY](#)

[CONTACT](#)

[Lap/Stitch Screws](#)

[Clips](#)



© Extreme Metal Fabricators.

APPENDIX D

10-2 Self Certification for Stormwater



FLORIDA DEPARTMENT OF
Environmental Protection

Bob Martinez Center
2600 Blair Stone Road
Tallahassee, Florida 32399-2400

Ron DeSantis
Governor

Jeanette Nuñez
Lt. Governor

Shawn Hamilton
Secretary

**SELF-CERTIFICATION FOR
A STORMWATER MANAGEMENT SYSTEM IN UPLANDS SERVING
LESS THAN 10 ACRES OF TOTAL PROJECT AREA AND
LESS THAN 2 ACRES OF IMPERVIOUS SURFACES**

Owner(s)/Permittee(s): Walton County Board of County Commissioners
File No: 0444962001EG
File Name: GLENDALE FIRE STATION
Site Address: Highway 2
Defuniak Springs FL - 32433
County: Walton
Latitude: 30° 54' 34.5286"
Longitude: -86° 7' 54.5415"
Total Project Area: 7.6
Total Impervious Surface Area: 1.3
**Approximate Date of Commencement
of Construction:** 04/01/2024

Registered Florida Professional: Rudy Mall
License No.: 94479
Company: Dewberry Engineers Inc.

Date: February 06, 2024

Rudy Mall certified through the Department's Enterprise Self-Service Application portal that the project described above was designed by the above-named Florida registered professional to meet the following requirements:

- (a) The total project area involves less than 10 acres and less than 2 acres of impervious surface;
- (b) Activities will not impact wetlands or other surface waters;
- (c) Activities are not conducted in, on, or over wetlands or other surface waters;
- (d) Drainage facilities will not include pipes having diameters greater than 24 inches, or the hydraulic equivalent, and will not use pumps in any manner;
- (e) The project is not part of a larger common plan, development, or sale; and
- (f) The project does not:
 - 1. Cause adverse water quantity or flooding impacts to receiving water and adjacent lands;

- 2.Cause adverse impacts to existing surface water storage and conveyance capabilities;
- 3.Cause a violation of state water quality standards; or
- 4.Cause an adverse impact to the maintenance of surface or ground water levels or surface water flows established pursuant to s. 373.042 or a work of the district established pursuant to s. 373.086, F.S.

This certification was submitted before initiation of construction of the above project. The system is designed, and will be operated and maintained in accordance with applicable rules adopted pursuant to part IV of chapter 373, F.S. There is a rebuttable presumption that the discharge from such system will comply with state water quality standards. Therefore, construction, alteration, and maintenance of the stormwater management system serving this project is authorized in accordance with s.403.814(12), F.S.

In accordance with s. 373.416(2), F.S., if ownership of the property or the stormwater management system is sold or transferred to another party, continued operation of the system is authorized only if notice is provided to the Department within 30 days of the sale or transfer. This notice can be submitted to:

FDEP Northwest District
160 Governmental Center
Pensacola, FL32502

This certification was submitted along with the following electronic documents:

| File Description |
|-------------------------|
| Stormwater Report |

If you have submitted this certification as a Florida Registered Professional, you may wish to sign and seal this certification, and return a copy to the Department, in accordance with your professional practice act requirements under Florida Statutes.

I, Rudy Mall, License No. 94479, do hereby certify that the above information is true and accurate, based upon my knowledge, information and belief. In the space below, affix signature, date, seal, company name, address and certificate of authorization (if applicable).

This sealed certification may be submitted to the Department, either electronically (as an attachment in Adobe PDF or other secure, digital format) at NWD_ERP_Applications@dep.state.fl.us, or as a hardcopy, at the postal address below:

FDEP Northwest District
160 Governmental Center
Pensacola, FL32502

APPENDIX E
FDOH Septic Permit



STATE OF FLORIDA
DEPARTMENT OF HEALTH
ONSITE SEWAGE TREATMENT AND DISPOSAL
SYSTEM

PERMIT #: 66-S4-2768004
APPLICATION #: AP1985236
DATE PAID: _____
FEE PAID: _____
RECEIPT #: _____
DOCUMENT #: PR2012436

CONSTRUCTION PERMIT FOR: OSTDS New
APPLICANT: (Walton County Board of Commissioners)
PROPERTY ADDRESS: Hwy 2 E & Hwy 83 Defuniak Springs, FL 32433
LOT: NA BLOCK: NA SUBDIVISION: N/A
PROPERTY ID #: 25-5N-19-21000-001-0040 [SECTION, TOWNSHIP, RANGE, PARCEL NUMBER]
[OR TAX ID NUMBER]

SYSTEM MUST BE CONSTRUCTED IN ACCORDANCE WITH SPECIFICATIONS AND STANDARDS OF SECTION 381.0065, F.S., AND CHAPTER 64E-6, F.A.C. DEPARTMENT APPROVAL OF SYSTEM DOES NOT GUARANTEE SATISFACTORY PERFORMANCE FOR ANY SPECIFIC PERIOD OF TIME. ANY CHANGE IN MATERIAL FACTS, WHICH SERVED AS A BASIS FOR ISSUANCE OF THIS PERMIT, REQUIRE THE APPLICANT TO MODIFY THE PERMIT APPLICATION. SUCH MODIFICATIONS MAY RESULT IN THIS PERMIT BEING MADE NULL AND VOID. ISSUANCE OF THIS PERMIT DOES NOT EXEMPT THE APPLICANT FROM COMPLIANCE WITH OTHER FEDERAL, STATE, OR LOCAL PERMITTING REQUIRED FOR DEVELOPMENT OF THIS PROPERTY.

SYSTEM DESIGN AND SPECIFICATIONS

T [1,050] GALLONS GPD _____ Septic Tank _____ CAPACITY
A [0] GALLONS / GPD _____ CAPACITY
N [0] GALLONS GREASE INTERCEPTOR CAPACITY [MAXIMUM CAPACITY SINGLE TANK:1250 GALLONS]
K [] GALLONS DOSING TANK CAPACITY [] GALLONS @[] DOSES PER 24 HRS #Pumps []
D [1,000] SQUARE FEET _____ Drainfield _____ SYSTEM
R [0] SQUARE FEET _____ SYSTEM
A TYPE SYSTEM: [X] STANDARD [] FILLED [] MOUND [] _____
I CONFIGURATION: [X] TRENCH [] BED [] _____
N
F LOCATION OF BENCHMARK: Top of nail w/blue ribbon on 4x4 post near Hwy 83
I ELEVATION OF PROPOSED SYSTEM SITE [1.00] [INCHES] FT [] [ABOVE / BELOW] BENCHMARK/REFERENCE POINT
E BOTTOM OF DRAINFIELD TO BE [13.00] [INCHES] FT [] [ABOVE / BELOW] BENCHMARK/REFERENCE POINT
L
D FILL REQUIRED: [6.00] INCHES EXCAVATION REQUIRED: [0.00] INCHES

Variance approval for #16045 received 3/8/24.
This permit is approved for fire station with 7 bunks, for a total estimate flow of 400 gpd.
The licensed contractor installing the system is responsible for installing the minimum category of tank in accordance with s. 62-6.013(3)(f), FAC. Outlet filter required. Observe all setbacks. Maintain 100 feet from Limited Use well. Proper connection of structure to septic tank must be verified before final approval. (Comments Continued on Page 2.)

SPECIFICATIONS BY: Suzanne M Floyd TITLE: Environmental Specialist III
APPROVED BY: [Signature] TITLE: Environmental Specialist III Walton CHD
DATE ISSUED: 03/18/2024 EXPIRATION DATE: 04/05/2025

DEP 4015, 06-21-2022 (Obsoletes previous editions which may not be used)
Incorporated 62-6.004, FAC

A reinspection fee will be charged for additional inspections.

Septic system drainfield to be installed in single trenches, due to the moderately limited soil present in the soil profile. To prevent soils smear and excessive soil compaction, drainfield shall NOT be installed in soils with textures finer than sand, loamy sand, or sandy loam when the soil moisture content is above the point at which the soil changes from semi-solid to plastic.

If drainfield is split, each portion must be equal in size and form a continuous loop.

Recommend installing drainfield across slope instead of down slope.

Additional fill may be required due to slope. Filled specifications may be required due to slope.

Ensure that storm water drainage is diverted away from the septic system.

Operating permit required prior to final approval.

OSTDS approval does not guarantee septic system performance.

NOTICE OF RIGHTS

A party whose substantial interest is affected by this order may petition for an administrative hearing pursuant to sections 120.569 and 120.57, Florida Statutes. Such proceedings are governed by Rule 28-106, Florida Administrative Code. A petition for administrative hearing must be in writing and must be received by the Agency Clerk for the Department, within twenty-one (21) days from the receipt of this order. The address of the agency clerk is 3900 Commonwealth Boulevard, Mail Station 35, Tallahassee, Florida 32399-3000. The Agency Clerk's email is agency_clerk@FloridaDEP.gov.

Mediation is not available as an alternative remedy.

Your failure to submit a petition for hearing within 21 days from receipt of this order will constitute a waiver of your right to an administrative hearing, and this order shall become a 'final order'.

Should this order become a final order, a party who is adversely affected by it is entitled to judicial review pursuant to Section 120.68, Florida Statutes. Review proceedings are governed by the Florida Rules of Appellate Procedure. Such proceedings may be commenced by filing one copy of a Notice of Appeal with the Agency Clerk of the Department of Environmental Protection and a second copy, accompanied by the filing fees required by law, with the Court of Appeal in the appropriate District Court. The notice must be filed within 30 days of rendition of the final order.



FLORIDA DEPARTMENT OF Environmental Protection

Northwest District
160 W. Government Street, Suite 308
Pensacola, Florida 32502-5740
NWD_EPOST@dep.state.fl.us

Ron DeSantis
Governor

Jeanette Nuñez
Lt. Governor

Shawn Hamilton
Secretary

March 18, 2024

Walton County Board of County Commissioners
c/o Rudy Mall, Dewberry Engineers, Inc.
877 N County Road 393
Santa Rosa Beach, FL 32459
(rmall@deberry.com)

Re: Glendale Fire Department – FLAB07441
Parcel No: 27-5N-19-21000-001-0040
FDOH Walton County #AP1985236
No Objection to the Use of an Onsite Sewage Treatment and Disposal System

Dear Mr. Mall:

This letter is sent in response to the proposed use of an onsite sewage treatment and disposal system (OSTDS) at the Glendale Fire Department establishment located at the northeast quadrant of the intersection of Hwy 2E & Hwy 83 in DeFuniak Springs, Walton County.

Based on a review of the information submitted to the Department (DEP) by the Florida Department of Health, Walton County, DEP has determined the following regarding the proposed use of an OSTDS at the establishment.

DEP determined the following with regard to the management of sewage wastes:

- The establishment will be required to obtain a wastewater facility permit under Chapter 403, F.S., for the entire flow of the establishment. DEP objects to the use of an OSTDS at this establishment.
- The establishment will be required to obtain a wastewater facility permit under Chapter 403, F.S., for the toxic, hazardous, or industrial wastewater-related flow and DEP does not object to the use of an OSTDS for only the domestic or commercial wastewater flow.
- The establishment will not be required to obtain a wastewater facility permit under Chapter 403, F.S., at this time, but DEP objects to the use of an OSTDS for the toxic, hazardous, or industrial wastewater-related flow (see the project description below regarding the management of any toxic, hazardous, or industrial wastewater), and does not object to the use of an OSTDS for only the domestic or commercial wastewater flow.

- The establishment will not be required to get a wastewater facility permit under Chapter 403, F.S., at this time and DEP has no objection to use of an OSTDS-permit for the type and quantity of wastewater generated by the establishment if a variance under section 381.0065, F.S., is granted. This is based on the information presented to DEP (see the project description below regarding the management of any toxic, hazardous, or industrial wastewater). If there is a change in circumstances that affects the waste discharged, a new review is necessary.

According to the information provided to DEP, the project for utilization of an OSTDS for onsite washing of personal protective equipment (PPE) is considered to be industrial waste. The wastewater flow is approximately 350 gallons per day and includes industrial wastewater from the laundry for this facility.

This letter regarding the use of an OSTDS is specific for the proposed project and/or purpose requested and is not transferable for any other use or any other owner or tenant without prior approval from DEP. The continued use of the OSTDS is contingent upon satisfactory system performance. When an approved sewage collection system becomes available, the owner of this system may be required to apply for a connection. Also, should the OSTDS prove to be inadequate to achieve acceptable treatment and disposal, or should regulations change, this establishment may be required to obtain a permit for a wastewater facility.

If this letter is used to obtain an OSTDS permit, it will be incorporated into the permit record. The use of this letter to obtain an OSTDS permit constrains the property owner, subsequent owners and leaseholders of the installation to agree to routine inspections of that facility and its source of wastes during reasonable business hours by DEP and/or the Florida Department of Health County Health Department.

Many commonly encountered materials may not be disposed of in an OSTDS because they are not biodegradable by the system, will contaminate groundwater, or impair the function of the system. Some examples of inappropriate materials are: solvents, thinners, fuels, lubricants, hydraulic oil, vehicle radiator fluid, pesticides, herbicides, inks, mineral acids, lye, photographic wastes, and chemical lab wastes. Disposal of all wastes shall be in accordance with appropriate regulations. This Department has the duty and reserves the right to take enforcement action for violations of ground water quality and surface water quality. Such enforcement action may, in part, require the owner at his or her own expense to install and operate a ground water monitoring system, prepare a contamination assessment plan, and provide remedial action to remove and dispose of environmentally offensive and health-threatening materials from the affected soil and water. Additionally, the Department may seek court-imposed penalties of up to \$10,000 per day for each day of water quality violation.

If you have any questions concerning this matter, please contact me at 850-595-0584.

Sincerely,



William A. Evans, P.E.

Water and Wastewater Permitting Manager

cc:

Suzanne Floyd, Florida DOH in Walton County (suzanne.floyd@flhealth.gov)

DEP Onsite Sewage Program (Elke.Ursin@FloridaDEP.gov)

Tony Cornman, Deputy County Administrator, Walton County (cortony@co.walton.fl.us)

Buddy Wright, Walton County Public Works Director (wribuddy@co.walton.fl.us)

Scott Caraway, Walton County Deputy Public Works Director (carscott@co.walton.fl.us)

Melinda Gates, Walton County Environmental Manager (gatmelinda@co.walton.fl.us)

Maurice Barker, FDEP (maurice.barker@floridadep.gov)

AP1985236



FLORIDA DEPARTMENT OF Environmental Protection

Bob Martinez Center
2600 Blair Stone Road
Tallahassee, FL 32399-2400

Ron DeSantis
Governor

Jeanette Nuñez
Lt. Governor

Shawn Hamilton
Secretary

March 8, 2024

Dewberry Engineers Inc., Agent for:
Walton County BOCC, Applicant
877 County Road 393 North
Santa Rosa Beach, Florida 32459

RE: Variance Request for an Onsite Sewage Treatment and Disposal System
Variance Application #16045
Florida Department of Health in Walton County Reference #AP1995236
Parcel ID number 27-5N-19-21000-001-0040
16, Walton County
Variance from section: 381.0065(4)(i), Florida Statutes (F.S.)
OGC Number: 24-0174

Dear Sir or Madam:

The Variance Review and Advisory Committee for the Onsite Sewage Treatment and Disposal Program has recommended approval, with provisos, of your application for variance in the case of the above referenced property. The advisory committee recommended the following requirements:

1. Obtain a No Objection letter from the Wastewater Program in the permitting area of the Northwest District of the Department of Environmental Protection. Contacts can be found at <https://floridadep.gov/northwest/nw-permitting/content/northwest-district-wastewater-program-contacts>.
2. Obtain an annual operating permit.

I concur with the advisory committee's recommendations and approve your variance subject to the requirements above. This variance, as approved, applies only to those sections of the law or rules referenced above and in no way exempts compliance with other state and local regulations. This variance will expire one year from the date of this letter, unless an onsite sewage treatment and disposal system construction permit is issued by the Florida Department of Health in Walton County, in which case the variance will run concurrent with the system construction permit.

Dewberry Engineers Inc., Agent for:
Walton County BOCC, Applicant (Variance #16045)
Page 2
March 8, 2024

If you have any questions, please contact Laura Kramer at 407-897-4301 or Laura.Kramer@FloridaDEP.gov.

Sincerely,



Kendra Goff, PhD, DABT, CPM, CEHP
Program Director
Division of Water Resource Management

KFG/lk
Enclosure

cc: Florida Department of Health in Walton County

Filing and Acknowledgement

Filed, on this date, pursuant to Section 120.52, Florida Statutes, (F.S.), with the designated Department Clerk, receipt of which is hereby acknowledged.

Lisa Williams
Clerk

03/11/2024
Date

NOTICE OF RIGHTS

This action is final and effective on the date filed with the Clerk of the Department unless a petition for an administrative hearing is timely filed under sections 120.569 and 120.57, F.S., before the deadline for filing a petition. On the filing of a timely and sufficient petition, this action will not be final and effective until further order of the Department. Because the administrative hearing process is designed to formulate final agency action, the hearing process may result in a modification of the agency action or even denial of the request for a variance or waiver.

Petition for Administrative Hearing

A person whose substantial interests are affected by the Department's action may petition for an administrative proceeding (hearing) under sections 120.569 and 120.57, F.S. Unless otherwise provided by statute, and except for agency enforcement and disciplinary actions that shall be initiated under Rule 28-106.2015, F.A.C., pursuant to Rule 28-106.201, F.A.C., a petition for an administrative hearing must contain the following information:

- a) The name and address of each agency affected and each agency's file or identification number, if known;
- b) The name, address, telephone number, and any e-mail address of the petitioner; the name, address, telephone number, and any e-mail address of the petitioner's representative, if any, which shall be the address for service purposes during the course of the proceeding; and an explanation of how the petitioner's substantial interests are or will be affected by the agency determination;
- c) A statement of when and how the petitioner received notice of the agency decision;
- d) A statement of all disputed issues of material fact. If there are none, the petition must so indicate;
- e) A concise statement of the ultimate facts alleged, including the specific facts that the petitioner contends warrant reversal or modification of the agency's proposed action;
- f) A statement of the specific rules or statutes that the petitioner contends require reversal or modification of the agency's proposed action, including an explanation of how the alleged facts relate to the specific rules or statutes; and
- g) A statement of the relief sought by the petitioner, stating precisely the action that the petitioner wishes the agency to take with respect to the agency's proposed action.

The petition must be filed (received by the Clerk) in the Office of General Counsel of the Department at 3900 Commonwealth Boulevard, Mail Station 35, Tallahassee, Florida 32399-3000. The Agency Clerk's email is agency_clerk@FloridaDEP.gov. Also, a copy of the petition shall be mailed to the applicant at the address indicated above at the time of filing.

Time Period for Filing a Petition

In accordance with Rule 62-110.106(3), F.A.C., petitions for an administrative hearing must be filed within 21 days of receipt of this written notice. The failure to file a petition within the appropriate time period shall constitute a waiver of that person's right to request an administrative determination (hearing) under sections 120.569 and 120.57, F.S., or to intervene in this proceeding and participate as a party to it. Any subsequent intervention (in a proceeding initiated by another party) will be only at the discretion of the presiding officer upon the filing of a motion in compliance with Rule 28-106.205, F.A.C.

Extension of Time

Under Rule 62-110.106(4), F.A.C., a person whose substantial interests are affected by the Department's action may also request an extension of time to file a petition for an administrative hearing. The Department may, for good cause shown, grant the request for an extension of time. Requests for extension of time must be filed with the Office of General Counsel of the Department at 3900 Commonwealth Boulevard, Mail Station 35, Tallahassee, Florida 32399-3000, before the applicable deadline for filing a petition for an administrative hearing. A timely request for extension of time shall toll the running of the time period for filing a petition until the request is acted upon.

Mediation

Mediation is not available in this proceeding.

Judicial Review

Once this decision becomes final, any party to this action has the right to seek judicial review pursuant to section 120.68, F.S., by filing a Notice of Appeal pursuant to Rules 9.110 and 9.190, Florida Rules of Appellate Procedure, with the Clerk of the Department in the Office of General Counsel, 3900 Commonwealth Boulevard, Mail Station 35, Tallahassee, Florida 32399-3000; and by filing a copy of the Notice of Appeal accompanied by the applicable filing fees with the appropriate District Court of Appeal. The Notice of Appeal must be filed within 30 days from the date this action is filed with the Clerk of the Department.



**STATE OF FLORIDA
DEPARTMENT OF ENVIRONMENTAL PROTECTION
APPLICATION FOR VARIANCE FROM CHAPTER 62-6, FAC
STANDARDS FOR ONSITE SEWAGE TREATMENT AND DISPOSAL SYSTEMS**
Authority: Chapter 381, Florida Statutes
Chapter 62-6, Florida Administrative Code

| |
|-------------------------------|
| Variance Application Number |
| |
| Onsite Sewage Office Use Only |
| |

Follow the instructions on the back of this form for assembling your application for variance. Eight (8) copies of this form and supporting documentation must be submitted with the required fee to your local county health department. Your application must be reviewed by the local county health department and the completed application received by the Bureau of Onsite Sewage Programs in Tallahassee no later than the 15th of the month to be placed on the agenda for the next monthly meeting of the variance review and advisory committee. If the 15th falls on a weekend or legal holiday, the deadline for receipt will be the next regular working day. If the variance request involves setbacks from wells or surface waters, the separation of the drainfield from the estimated wet season high water table, or the authorized sewage flow of the property, the county health department must post a sign on the property giving notice of the application for variance.

PART I - GENERAL INFORMATION

(To be completed by the applicant. See instructions on the back of this form.)
(TYPE OR PRINT LEGIBLY)

APPLICANT INFORMATION

Property Owner: WALTON COUNTY BOCC Phone: (W) (850) 891-8474 (H) () Email: SELDAVE@CO.WALTON.FL.GOV
 Owner's Agent: DEWBERRY ENGINEERS INC. (LUDY MALL) Phone: (W) (850) 571-1249 (H) () Email: RMALL@DEWBERRY.COM
 Mailing Address: 877 COUNTY ROAD 383 NORTH City: SANTA ROSA BEACH State: FL Zip: 32459

PROPERTY INFORMATION

Property Street Address: N/A City: _____ County: WALTON
 Lot: _____ Block: _____ Subdivision: _____ Unit: _____
 Section: 27 Township: 6N Range: 19W Parcel Number: 27-6N-19-21000-001-0040
 Metes & Bounds Description (Attach property legal description)

VARIANCE REQUEST INFORMATION

A variance may not be granted under section 381.0065, FS, until the department is satisfied the following conditions have been met.

Address each item explaining how your variance request satisfies the statutory conditions for a variance. Attach a separate sheet if necessary.

1. Please explain how your variance request satisfies the statutory requirement that the hardship was not caused intentionally by the action of the applicant. THE PROPOSED FILL STATION WILL BE UTILIZING THE WASHING SERVICES ON SITE TO WASH P.P.E. GEAR THAT MAY BE CONSIDERED AS INDUSTRIAL, HAZARDOUS, OR TOXIC WASTE.

2. Please explain how your variance request satisfies the statutory requirement that no reasonable alternative, taking into consideration factors such as cost exists for the treatment of the sewage. THERE IS CURRENTLY NO AVAILABLE SEWER ON SITE OR ANY OTHER REASONABLE ALTERNATIVE THAT EXISTS FOR THE PROPOSED TREATMENT OF THE SEWAGE.

3. Please explain how your variance request satisfies the statutory requirement that the discharge from the onsite sewage treatment and disposal system will not adversely affect the health of the applicant or the public or significantly degrade the groundwater or surface waters. ACCORDING TO RECENT GEOTECHNICAL INVESTIGATIONS DONE FOR THE PROJECT SITE, THE DEPTH TO GROUND WATER EXCEEDS 10-FT FOR TEST LOCATIONS NEAR THE DRAINFIELD, AND THEREFORE THE EXISTING GROUND WATER SHOULD NOT BE ADVERSELY AFFECTED. THE PROPOSED DRAIN FIELD LOCATION PROVIDES ADEQUATE SEPERATION FROM ANY NEARBY SURFACE WATERS.

I attest the above information is true. I acknowledge that in the submission of this variance request, I hereby authorize department employees to enter onto my property to conduct inspection activities and to post public notice of this variance request.

Signature of Owner or Agent: _____ Date: 10, 9, 2023

Mission:

To protect, promote & improve the health of all people in Florida through integrated state, county & community efforts.



Ron DeSantis
Governor

Joseph A. Ladapo, MD, PhD
State Surgeon General

Vision : To be the Healthiest State in the Nation

September 08, 2023

Rudy Mall (Dewberry Engineers Inc)
877 N County Road 393
Santa Rosa Beach, FL 32459

Application Denial and Notice of Right to Administrative Proceedings
Application Document No: AP1985236
Hwy 2 E & Hwy 83
Defuniak Springs, FL 32433
Lot: NA Block: NA Subdivision: N/A

Dear Applicant:

This will acknowledge receipt of an application and plans for an onsite sewage treatment and disposal system construction permit dated August 22, 2023 for a proposed system to be constructed on the above referenced property.

You are hereby notified that your application is denied because the proposal described does not meet the requirements of section 381.0065, Florida Statutes, or Chapter 62-6, Florida Administrative Code. Specifically the proposal has the following violations:

| <u>Code Citation</u> | <u>Letter Detail</u> | <u>Code Citation Description</u> |
|----------------------|--|--|
| 62-6.002(29), F.A.C. | Fire station intends to wash personal protective equipment (PPE) on site which may contain industrial, hazardous, or toxic sewage waste. | Industrial, hazardous, or toxic sewage waste |

As an applicant who has been denied a permit, you have the right to request a variance or hearing to appeal the department's action. Requests for a hearing must be made to this office in writing no later than 21 days from the receipt of this letter. Mediation pursuant to S.120.573, Florida Statutes, is not available to resolve this dispute.

JAL

Rudy Mall (Dewberry Engineers Inc)
Page two
September 08, 2023

Your lot may qualify for a performance based treatment system under Part IV, Chapter 62-6, Florida Administrative Code. You should consult with a professional engineer registered in Florida for further information on performance based systems.

If you have any questions on this matter, please call our office at (850) 401-6360.

Sincerely,

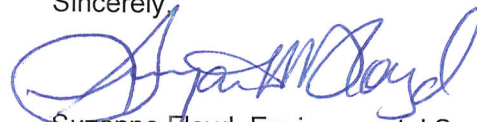
A handwritten signature in blue ink, appearing to read "Suzanne Floyd". The signature is fluid and cursive, with the first name being more prominent.

Suzanne Floyd, Environmental Specialist III

NOTICE TO POTENTIAL VARIANCE APPLICANTS

If pursuing a variance application, please note that the following information is taken from the section of Florida Statutes dealing with variance applications for onsite sewage treatment and disposal systems. To find the Florida Statutes on the internet, please go to <http://www.leg.state.fl.us/Statutes/index.cfm>. Scroll down and click on "Title XXIX." Find and click on "Chapter 381." Find and click on "381.0065." The citation to look for is Chapter 381.0065(4)(h)1., Florida Statutes.

The department may grant variances in hardship cases which may be less restrictive than the provisions specified in this section. A variance may not be granted under this section until the department is satisfied that:

- a. The hardship was not caused intentionally by the action of the applicant;
- b. No reasonable alternative, taking into consideration factors such as cost, exists for the treatment of the sewage; and
- c. The discharge from the onsite sewage treatment and disposal system will not adversely affect the health of the applicant or the public or significantly degrade the groundwater or surface waters.

Where soil conditions, water table elevation, and setback provisions are determined by the department to be satisfactory, special consideration must be given to those lots platted before 1972.

While the final authority to grant or deny variances rests solely with the Department of Environmental Protection, variance applications are reviewed by a State Variance Review and Advisory Committee. The committee meets once a month in a predetermined location in Florida. You are invited to attend, at your own expense, or send someone to represent you. The committee will evaluate your request during the meeting, and will make a recommendation on the disposition of your application to the Department.

Please note there are specific requirements and deadlines for variance applications. Please call your local county health department representative for information on how to file for a variance request.



STATE OF FLORIDA
DEPARTMENT OF HEALTH
ON-SITE SEWAGE TREATMENT AND DISPOSAL
SYSTEM
APPLICATION FOR CONSTRUCTION PERMIT

PERMIT NO. AP1985236
DATE PAID: _____
FEE PAID: _____
RECEIPT #: 60-54-2768004

APPLICATION FOR:

- New System Existing System Holding Tank Innovative
 Repair Abandonment Temporary _____

APPLICANT: Walton County Board of County Commissioners

AGENT: Dewberry Engineers Inc. TELEPHONE: _____

MAILING ADDRESS: 877 County Road 393 North, Santa Rosa Beach, FL 32459

TO BE COMPLETED BY APPLICANT OR APPLICANT'S AUTHORIZED AGENT. SYSTEMS MUST BE CONSTRUCTED BY A PERSON LICENSED PURSUANT TO 489.105(3) (m) OR 489.552, FLORIDA STATUTES. IT IS THE APPLICANT'S RESPONSIBILITY TO PROVIDE DOCUMENTATION OF THE DATE THE LOT WAS CREATED OR PLATTED (MM/DD/YY) IF REQUESTING CONSIDERATION OF STATUTORY GRANDFATHER PROVISIONS.

PROPERTY INFORMATION

LOT: NA BLOCK: NA SUBDIVISION: N/A PLATTED: 4-19-83

PROPERTY ID #: SWP 27 28-5N-19-21000-001-0040 ZONING: COM I/M OR EQUIVALENT: [No]

PROPERTY SIZE: 7.58 ACRES WATER SUPPLY: [] PRIVATE PUBLIC [] <=2000GPD [] >2000GPD

IS SEWER AVAILABLE AS PER 381.0065, FS? [No] DISTANCE TO SEWER: _____ FT

PROPERTY ADDRESS: Northeast quadrant of the intersection of Highway 2 E and State Highway 83.

DIRECTIONS TO PROPERTY: Located northeast of intersection Highway 2 E and State Highway 83.

BUILDING INFORMATION

[] RESIDENTIAL [] COMMERCIAL

| Unit No | Type of Establishment | No. of Bedrooms | Building Area Sqft | Commercial/Institutional System Design Table 1, Chapter 64E-6, FAC |
|---------|-----------------------|-----------------|--------------------|--|
| 1 | Fire Station | 7-Bunks | 8,120 | 400 GPD; Max # of Employees = 7; Max # of Meals = 21 |
| 2 | _____ | _____ | _____ | _____ |
| 3 | _____ | _____ | _____ | _____ |
| 4 | _____ | _____ | _____ | _____ |

[] Floor/Equipment Drains [] Other (Specify) N/A

SIGNATURE: _____ DATE: 8/21/23

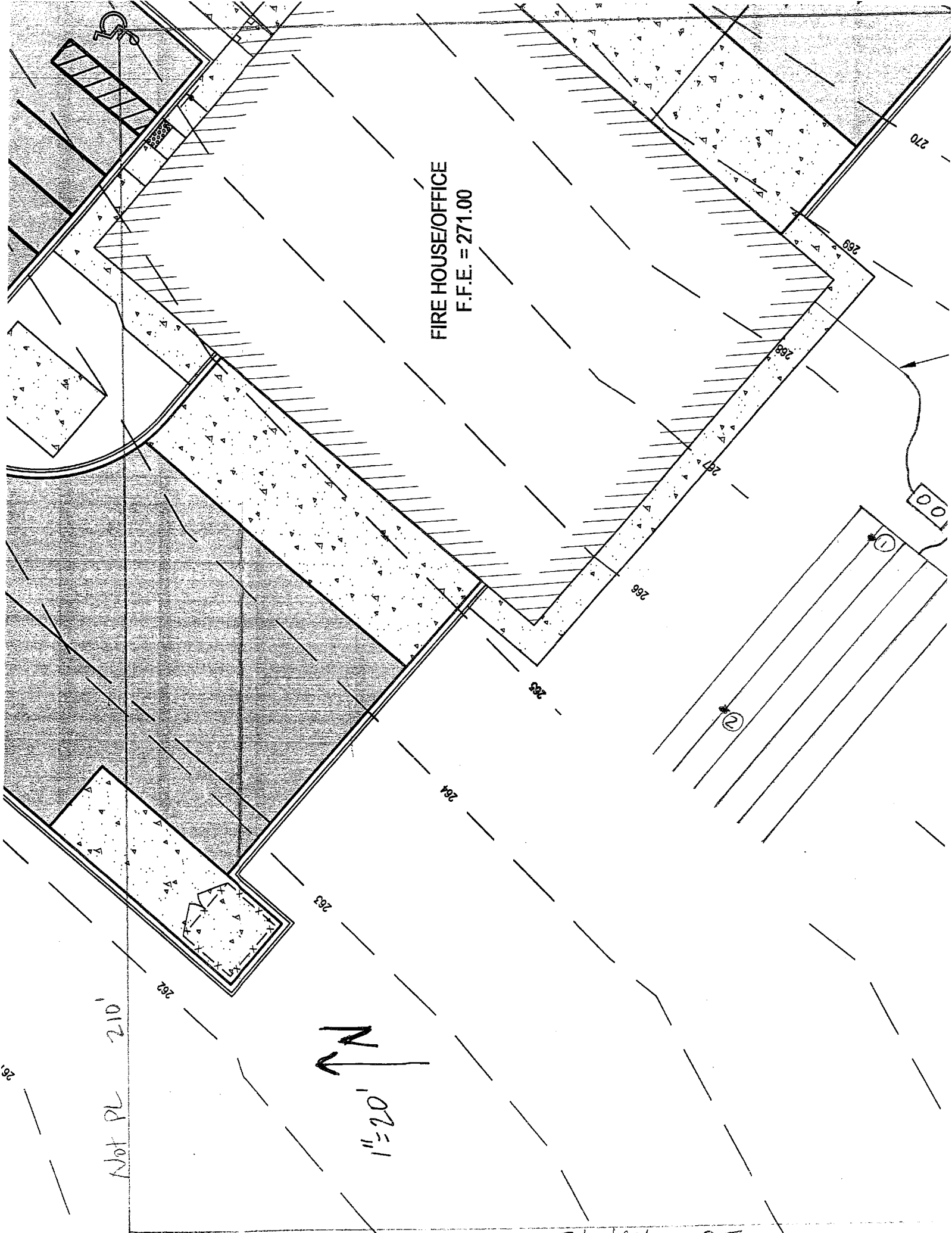

FIRE HOUSE/OFFICE
F.F.E. = 271.00

1" = 20'
N

Not PL 210'

270

269

268

267

266

265

264

263

262

261

FIELD (DESIGN BY OTHER)

PROPOSED 4" PVC SANITARY SEWER LINE

← slope 4%

1.01 Acres of parcel

NOT PL

210'

IDE FACILITIES, STRUCTURES, AND UTILITIES HAVE BEEN PLOTTED
ON THE INFORMATION AND SURVEYS AVAILABLE AT THE TIME OF
OF THESE FEATURES MUST, THEREFORE, BE CONSIDERED
MAY BE OTHER FACILITIES, STRUCTURES, AND UTILITIES WHICH DID
WAS NOT KNOWN) AT THE TIME OF DRAWING PREPARATION. IT IS
ACTOR(S) TO HAVE ALL EXISTING FACILITIES, STRUCTURES, AND
ANY EXCAVATION OR CONSTRUCTION ACTIVITY; AND TO PROTECT
HOSE SPECIFICALLY NOTED FOR REMOVAL OR DEMOLITION) DURING

Approved by:



FDH-Walton

10/19/2023

Bm

266

267

2)

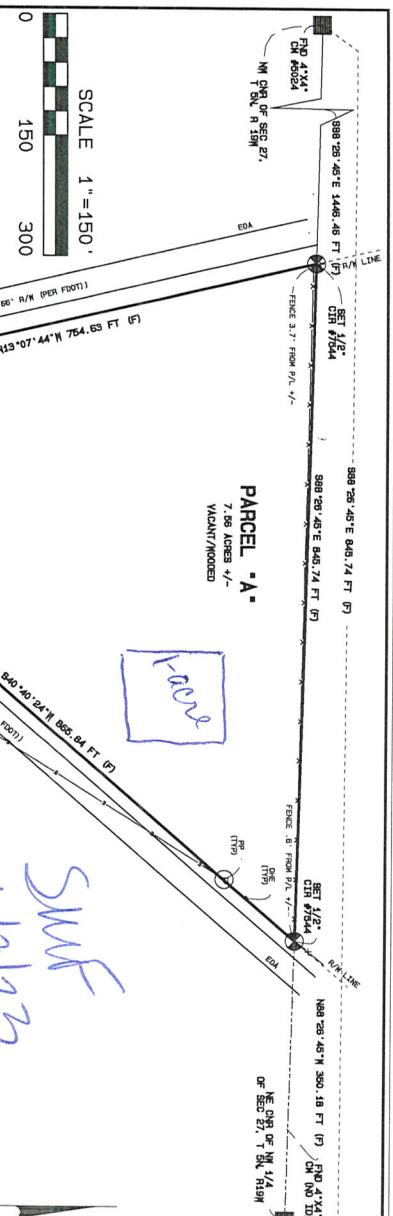

LEGEND OF ABBREVIATIONS

1A - LICENSE SURVEYS
 1B - IRON ROD MONUMENT
 1C - IRON PIPE MONUMENT
 1D - CONCRETE MONUMENT
 1E - BRASS MONUMENT
 1F - BRASS MARKER
 1G - BRASS BULLOCK
 1H - BRASS BULLOCK
 1I - BRASS BULLOCK
 1J - BRASS BULLOCK
 1K - BRASS BULLOCK
 1L - BRASS BULLOCK
 1M - BRASS BULLOCK
 1N - BRASS BULLOCK
 1O - BRASS BULLOCK
 1P - BRASS BULLOCK
 1Q - BRASS BULLOCK
 1R - BRASS BULLOCK
 1S - BRASS BULLOCK
 1T - BRASS BULLOCK
 1U - BRASS BULLOCK
 1V - BRASS BULLOCK
 1W - BRASS BULLOCK
 1X - BRASS BULLOCK
 1Y - BRASS BULLOCK
 1Z - BRASS BULLOCK

BOUNDARY SURVEY

OF
 A PARCEL OF LAND LYING
 IN SECTION 27, TOWNSHIP 5N,
 RANGE 19W, MALTON COUNTY,
 FLORIDA

DESCRIPTION PARCEL "A"

AS PROVIDED:
 ALL THAT PORTION OF THE NE 1/4 OF NW 1/4 LYING EAST OF STATE ROAD 493 AND NORTH AND WEST
 OF STATE ROAD #2 IN SECTION 27, TOWNSHIP 6 NORTH, RANGE 19 WEST, MALTON COUNTY, FLORIDA.

SURVEY NOTES AND REPORT

- 1) BEARING BASTIS IS THE 4"x4" CM #5024 AND THE 4"x4" CM ALONG THE NORTHERLY LINE OF SEC 27 AS BEING S89°26'45" E (STATE PLANE COORDINATE SYSTEM, ZONE FLORIDA NORTH, NORTH AMERICAN DATUM 1983)
- 2) SURVEY PERFORMED WITH THE BENEFIT OF TITLE SEARCH PROVIDED BY: ALLIANT NATIONAL TITLE INSURANCE COMPANY, EFFECTIVE DATE: MARCH 14, 2023. AGENT'S FILE REFERENCE: 20102097. PROPOSED INSURED: MALTON COUNTY SHERIFF'S OFFICE
- 3) INTERNAL IMPROVEMENTS WERE NOT LOCATED, EXCEPT AS SHOWN. UNDERGROUND UTILITIES, FOUNDATIONS OR OTHER NON-VISIBLE STRUCTURES OR ENCROACHMENTS, IF ANY, WERE NOT LOCATED.
- 4) PORTIONS OF THE PROPERTY SHOWN HEREON MAY BE ENVIRONMENTALLY SENSITIVE AND SUBJECT TO STATE AND/OR FEDERAL JURISDICTION AND/OR REGULATION. PERMITS MAY BE REQUIRED FOR DISTURBANCE TO THESE AREAS.
- 5) CLIENT IS ADVISED TO SEEK LEGAL COUNSEL BEFORE CONSTRUCTING OR MOVING FENCES OR OTHER STRUCTURES.
- 6) BASED ON REVIEW OF THE NATIONAL FLOOD INSURANCE RATE MAP OF MALTON COUNTY, FLORIDA, PANEL NUMBERS 12131C00706 DATED 09/29/10. THE SUBJECT PROPERTY LIES IN ZONE "X".
- 7) SURVEY MAP INFORMATION SHOWN HEREON WAS DERIVED FROM FIELD MEASUREMENTS UNLESS OTHERWISE DENOTED.
- 8) THIS SURVEY WAS PREPARED FOR THE CLIENT'S USE AND PURPOSE AS SHOWN. CLAIMS AND INTERESTS OF OTHER PARTIES ARE NOT REPRESENTED AND SHALL NOT BE MADE WITHOUT THE EXPLICIT WRITTEN PERMISSION OF THE SURVEYOR.
- 9) THIS SURVEY MEETS OR EXCEEDS THE STANDARDS OF PRACTICE FOR ACCURACY.

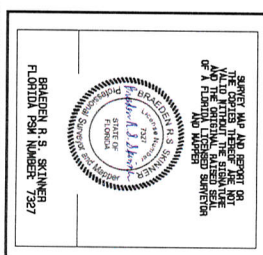

CLIENT:
 MALTON COUNTY
 SHERIFF'S OFFICE

CERTIFIED TO:
 ALLIANT NATIONAL TITLE
 SURVEY COMPANY
 MITCHELL LAND & TITLE, INC.

DATE OF SURVEY:
 MARCH 22, 2023

FIELD BOOK:
 27-SN-19-21000-001-0020

SURVEY TOP: 23471

DRAWN BY:
 SETH SKINNER
 JANIE CARROLL

REVISED DATE:
 JUNE 2023

ADDED COMMITMENT

REVISED DATE:
 AUGUST 29, 2023

ADDED COMMITMENT
 MODIFYING ALONG
 NORTH LINE

NOTE: THIS SURVEY WAS ELECTRONICALLY SIGNED AND SEALED BY: BRADEN R. S. SKINNER, PSM ON AUGUST 29, 2023 AS PER THE RULES SET FORTH IN 51-17 FAC PERMITTING ELECTRONIC SIGNATURES AND SEALS BY PROFESSIONAL SURVEYORS AND MAPPERS

LAND ENGINEERING SERVICES, INC.

P. O. BOX 49
 3761 U.S. HWY 90 E
 DEFWIAK SPRINGS,
 FL 32433

PHONE: 850-892-3639
 FAX: 850-892-6326
 LB#7544

BRADEN R. S. SKINNER
 FLORIDA PSM NUMBER 7327

FIELD (DESIGN BY OTHER)

PROPOSED 4" PVC SANITARY SEWER LINE

Slope 4.9%

1.01 Acres of Parcel

210'

NOT PL

(S):
GRADE FACILITIES, STRUCTURES, AND UTILITIES HAVE BEEN PLOTTED ON THE INFORMATION AND SURVEYS AVAILABLE AT THE TIME OF THESE FEATURES MUST, THEREFORE, BE CONSIDERED TO BE OTHER FACILITIES, STRUCTURES, AND UTILITIES WHICH DID NOT EXIST AT THE TIME OF DRAWING PREPARATION. IT IS THE RESPONSIBILITY OF THE CONTRACTOR TO VERIFY THE LOCATION AND DEPTH OF ANY EXCAVATION OR CONSTRUCTION ACTIVITY; AND TO PROTECT THOSE SPECIFICALLY NOTED FOR REMOVAL OR DEMOLITION) DURING

Approved by:

[Signature]

FD04-Walton

10/9/2023

BM

1" = 20'
N

Not PL 210'

26.

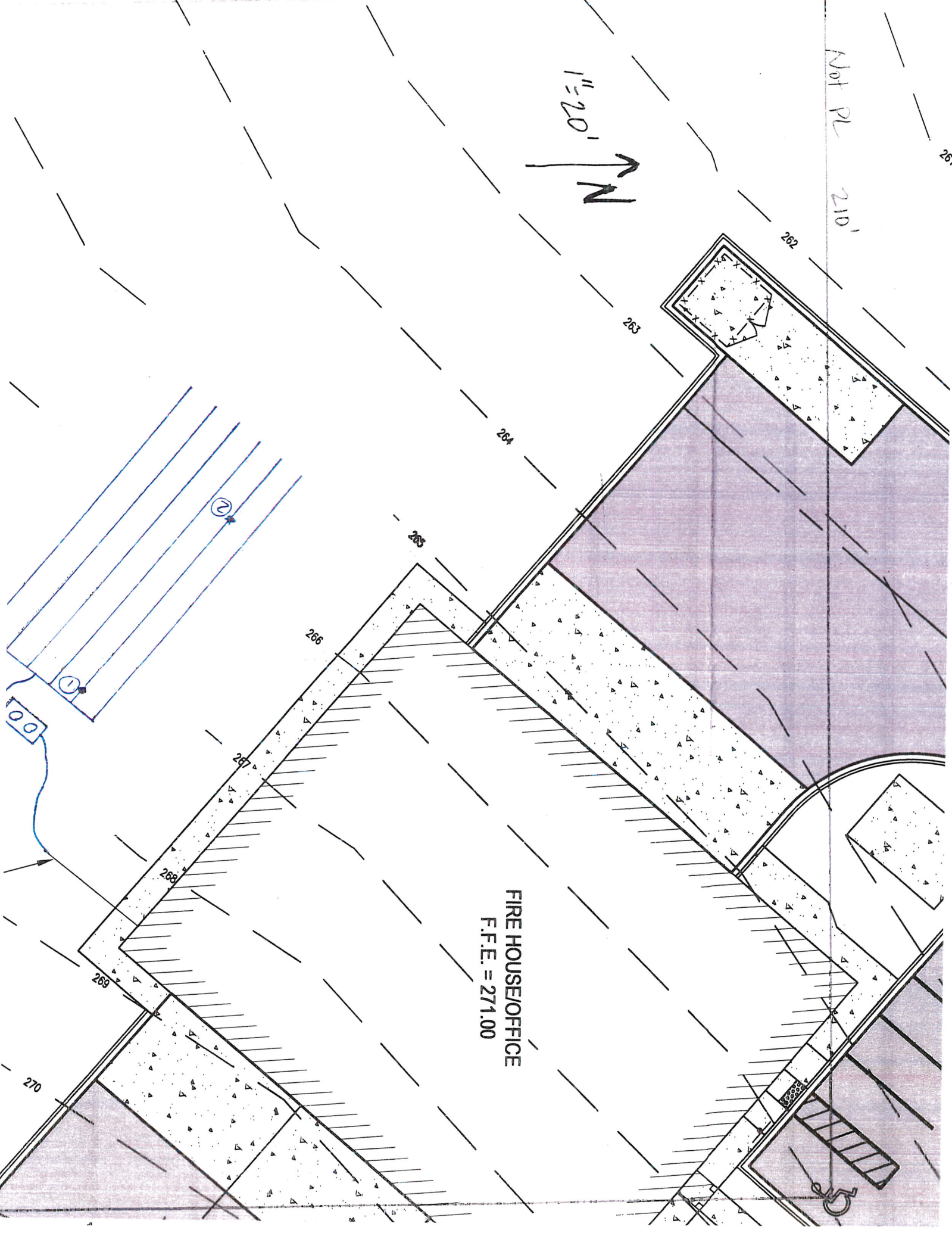

FIRE HOUSE/OFFICE
F.F.E. = 271.00

270

269

268

267

266

265

264

263

262



STATE OF FLORIDA
DEPARTMENT OF HEALTH
ONSITE SEWAGE TREATMENT AND DISPOSAL SYSTEM
SITE EVALUATION AND SYSTEM SPECIFICATION

APPLICATION # AP1985236
PERMIT # 66-S4-2768004
DOCUMENT # SE1911264

APPLICANT: Walton County Board of Commissioners

CONTRACTOR / AGENT: Dewberry Engineers Inc

LOT: NA

BLOCK: NA

SUBDIVISION: N/A ID#: 25-5N-19-21000-001-0040

TO BE COMPLETED BY ENGINEER, HEALTH DEPARTMENT EMPLOYEE, OR OTHER QUALIFIED PERSON. ENGINEERS MUST PROVIDE REGISTRATION NUMBER AND SIGN AND SEAL EACH PAGE OF SUBMITTAL. COMPLETE ALL ITEMS.

PROPERTY SIZE CONFORMS TO SITE PLAN: YES NO NET USABLE AREA AVAILABLE: 7.58 ACRES
TOTAL ESTIMATED SEWAGE FLOW: 350 GALLONS PER DAY [RESIDENCES-TABLE1 / OTHER-TABLE 2]
AUTHORIZED SEWAGE FLOW: 11370.01 GALLONS PER DAY [1500 GPD/ACRE OR 2500 GPD/ACRE]
UNOBSTRUCTED AREA AVAILABLE: 3000.00 SQFT UNOBSTRUCTED AREA REQUIRED: 1500.00 SQFT

BENCHMARK/REFERENCE POINT LOCATION: Top of nail w/blue ribbon on 4x4 post near Hwy 83
ELEVATION OF PROPOSED SYSTEM SITE 1.00 [INCHES / FT] [ABOVE / BELOW] BENCHMARK/REFERENCE POINT

THE MINIMUM SETBACK WHICH CAN BE MAINTAINED FROM THE PROPOSED SYSTEM TO THE FOLLOWING FEATURES
SURFACE WATER: N/A FT DITCHES/SWALES: N/A FT NORMALLY WET: YES NO
WELLS: PUBLIC: N/A FT LIMITED USE: 300+ FT PRIVATE: N/A FT NON-POTABLE: N/A FT
BUILDING FOUNDATIONS: 30 FT PROPERTY LINES: +100 FT POTABLE WATER LINES: 132 FT

SITE SUBJECT TO FREQUENT FLOODING? YES NO 10 YEAR FLOODING? YES NO
10 YEAR FLOOD ELEVATION FOR SITE: NA FT [MSL / NGVD] SITE ELEVATION: NA FT [MSL / NGVD]

SOIL PROFILE INFORMATION SITE 1

| USDA SOIL SERIES:Dothan loamy sand, 2 to 5 percent | | |
|--|-----------------|----------|
| Munsell #/Color | Texture | Depth |
| 10YR 4/2 | Sandy Loam | 0 To 8 |
| 10YR 6/6 | Sandy Clay Loam | 2 To 4 |
| 10YR 5/4 | Sandy Loam | 8 To 16 |
| 5YR 5/8 | Sandy Loam | 8 To 10 |
| 10YR 5/6 | Sandy Clay Loam | 16 To 30 |
| 5YR 5/6 | Sandy Clay Loam | 27 To 30 |
| 5YR 5/6 | Sandy Clay | 30 To 36 |
| 10YR 5/6 | Sandy Clay | 30 To 36 |
| 10YR 7/3 | Sandy Clay | 34 To 36 |
| 10YR 7/2 | CMN/PRM RF | 36 To 46 |
| 5YR 6/8 | Sandy Clay | 40 To 72 |
| 10YR 7/4 | Sandy Clay | 46 To 72 |
| 7.5YR 8/1 | CMN/PRM RF | 46 To 72 |
| 2.5YR 6/6 | Sandy Clay | 50 To 63 |
| 10YR 7/6 | Sandy Clay | 61 To 72 |
| 10YR 5/4 | Sandy Clay | 61 To 72 |
| 2.5YR 5/6 | Sandy Clay | 63 To 72 |

SOIL PROFILE INFORMATION SITE 2

| USDA SOIL SERIES:Dothan loamy sand, 2 to 5 percent | | |
|--|-----------------|----------|
| Munsell #/Color | Texture | Depth |
| 10YR 4/2 | Sandy Loam | 0 To 8 |
| 10YR 5/4 | Sandy Loam | 4 To 14 |
| 10YR 5/8 | Sandy Loam | 14 To 24 |
| 10YR 6/6 | Sandy Clay Loam | 24 To 34 |
| 10YR 6/6 | Sandy Clay | 34 To 48 |
| 10YR 5/6 | Sandy Clay | 38 To 59 |
| 10YR 7/2 | CMN/PRM RF | 48 To 72 |
| 10YR 7/3 | Sandy Clay | 50 To 59 |
| 10YR 6/8 | Sandy Clay | 50 To 59 |
| 5YR 5/8 | Sandy Clay | 50 To 72 |
| 10YR 6/8 | Sandy Loam | 59 To 72 |
| 5YR 7/3 | Sandy Loam | 59 To 72 |

OBSERVED WATER TABLE: > 72.00 INCHES [ABOVE / BELOW] EXISTING GRADE TYPE: [PERCHED / APPARENT]
ESTIMATED WET SEASON WATER TABLE ELEVATION: 36 INCHES [ABOVE / BELOW] EXISTING GRADE
HIGH WATER TABLE VEGETATION: YES NO MOTTLING: YES NO DEPTH: 36.00 INCHES



STATE OF FLORIDA
DEPARTMENT OF HEALTH
ONSITE SEWAGE TREATMENT AND DISPOSAL SYSTEM
SITE EVALUATION AND SYSTEM SPECIFICATION

APPLICATION # AP1985236
PERMIT # 66-S4-2768004
DOCUMENT # SE1911264

SOIL TEXTURE/LOADING RATE FOR SYSTEM SIZING: Sandy Clay/0.35 DEPTH OF EXCAVATION: _____ INCHES
DRAINFIELD CONFIGURATION: TRENCH BED OTHER (SPECIFY) _____

REMARKS/ADDITIONAL CRITERIA

SP1: 1"BBM, SP1: 20.5"BBM. Sunny day. 4% slope to the north. Additional fill may be required due to slope.

SITE EVALUATED BY:

Floyd, Suzanne (Title: Environmental Specialist III) (FDOH in Walton County)

DATE: 09/22/2023

DEP 4015, 06-21-2022 (Obsoletes previous editions which may not be used)
Incorporated 62-6.004, FAC

Page 3 of 4

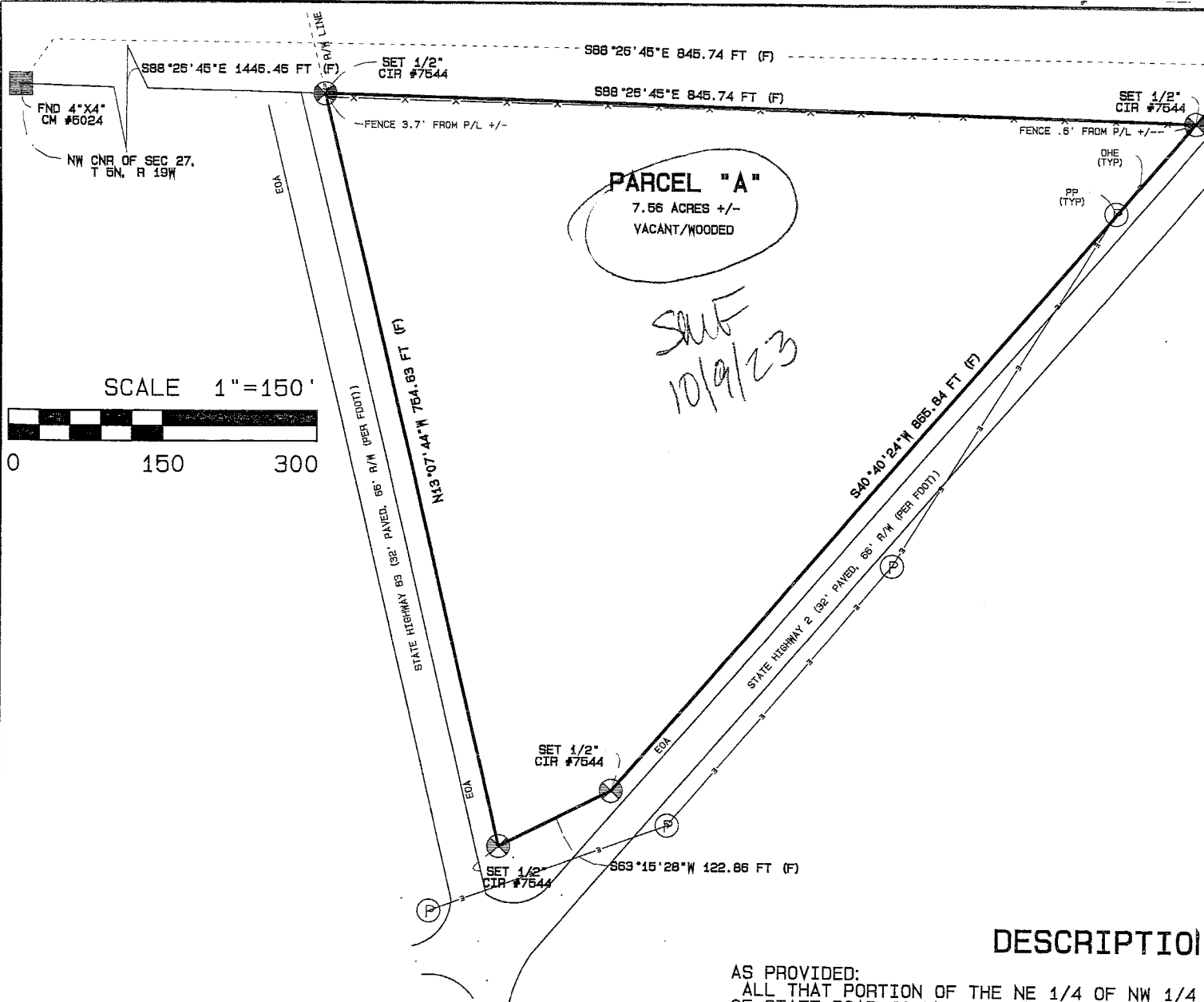

DESCRIPTION

AS PROVIDED:
 ALL THAT PORTION OF THE NE 1/4 OF NW 1/4
 OF STATE ROAD #2 IN SECTION 27, TOWNSHIP !

SURVEY NOTES AND REPORT

- 1) BEARING BASIS IS THE 4"x4" CM #5024 AND THE 4"x4" CM ALONG THE NORTHERLY LINE OF SEC 27 AS BEING S88°26'45"E (STATE PLANE COORDINATE SYSTEM, ZONE FLORIDA NORTH, NORTH AMERICAN DATUM 1983)
- 2) SURVEY PERFORMED WITH THE BENEFIT OF TITLE SEARCH PROVIDED BY: ALLIANT NATIONAL TITLE INSURANCE COMPANY.
 EFFECTIVE DATE: MARCH 14, 2023, AGENTS FILE REFERENCE: 20102097,
 PROPOSED INSURED: WALTON COUNTY SHERRIFF'S OFFICE
- 3) INTERNAL IMPROVEMENTS WERE NOT LOCATED, EXCEPT AS SHOWN. UNDERGROUND UTILITIES, FOUNDATIONS OR OTHER NON-VISIBLE STRUCTURES OR ENCROACHMENTS, IF ANY, WERE NOT LOCATED.
- 4) PORTIONS OF THE PROPERTY SHOWN HEREON MAY BE ENVIRONMENTALLY SENSITIVE AND SUBJECT TO STATE AND/OR FEDERAL JURISDICTION AND/OR REGULATION. PERMITS MAY BE REQUIRED FOR DISTURBANCE TO THESE AREAS.
- 5) CLIENT IS ADVISED TO SEEK LEGAL COUNSEL BEFORE CONSTRUCTING OR MOVING FENCES OR OTHER STRUCTURES.
- 6) BASED ON REVIEW OF THE NATIONAL FLOOD INSURANCE RATE MAP OF WALTON COUNTY, FLORIDA, PANEL NUMBERS 12131C00706 DATED 09/29/10, THE SUBJECT PROPERTY LIES IN ZONE "X"
- 7) SURVEY MAP INFORMATION SHOWN HEREON WAS DERIVED FROM FIELD MEASUREMENTS UNLESS OTHERWISE DENOTED.
- 8) THIS SURVEY WAS PREPARED FOR THE CLIENT'S USE AND PURPOSE AS SHOWN. USAGE FOR ANY OTHER PURPOSE, REPRODUCTIONS (IN WHOLE OR IN PART) SHALL NOT BE MADE WITHOUT THE EXPLICIT WRITTEN PERMISSION OF THE SURVEYOR.
- 9) THIS SURVEY MEETS OR EXCEEDS THE STANDARDS OF PRACTICE FOR ACCURACY.

- 10) EXCEPT RENDERS NC TO BE WITH
- 11) EXCEPT OF THE PER
- 12) EXCEPT:

LEGEND OF ABBREVIATIONS

N88°26'45"W 350.18 FT (F) FND 4"x4" CH (NO ID)
 NE CNR OF NW 1/4 OF SEC 27, T 5N, R19W

- FND - FOUND
- CIR - CAPPED IRON ROD
- POC - POINT OF COMMENCEMENT
- POB - POINT OF BEGINNING
- APP - APPARENT
- P/L - PROPERTY LINE
- P/C - PROPERTY CORNER
- N/D - NAIL IN DISK
- CLF - CHAIN LINK FENCE
- WBF - WOOD BOARD FENCE
- WMF - WIRE MESH FENCE
- BWF - BARB WIRE FENCE
- DIA - DIAMETER
- PP - POWER POLE
- OHE - OVERHEAD ELECTRIC
- OR - OFFICIAL RECORD
- SEC - SECTION
- T - TOWNSHIP
- R - RANGE
- √ - NOT TO SCALE
- FT - FEET
- # - NUMBER
- +/- - MORE OR LESS
- EW - EDGE OF WATER
- MP - METALLIC POINT
- LB - LICENSE BUSINESS
- IR - IRON ROD
- CM - CONCRETE MONUMENT
- IP - IRON PIPE
- ID - IDENTIFICATION
- C/L - CENTERLINE
- EOA - EDGE OF ASPHALT
- EOD - EDGE OF DIRT
- CNR - CORNER
- F - FIELD
- P - PLAT
- D - DEED
- EL - ELEVATION
- FFE - FINISHED FLOOR ELEVATION
- WM - WATER METER
- PG - PAGE
- R/W - RIGHT-OF-WAY
- LB - LICENSE BUSINESS
- PE - PROFESSIONAL ENGINEER
- PSM - PROFESSIONAL SURVEYOR AND MAPPER
- P.O. - POST OFFICE
- OHE - OVERHEAD ELECTRIC
- PP - POWER POLE
- TYP - TYPICAL
- EM - ELECTRIC METER
- EB - ELECTRIC BOX
- TBM - TEMPORARY BENCHMARK
- PK NAIL - PARKER KALON NAIL

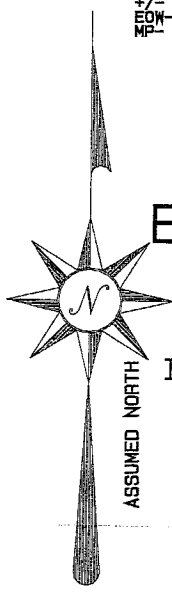

BOUNDARY SURVEY
 OF
 A PARCEL OF LAND LYING
 IN SECTION 27, TOWNSHIP 5N,
 RANGE 19W, WALTON COUNTY,
 FLORIDA

PARCEL "A"

NG EAST OF STATE ROAD #83 AND NORTH AND WEST
 RTH, RANGE 19 WEST, WALTON COUNTY, FLORIDA.

1 THROUGH 10 AND 14 ARE NOT SURVEY RELATED AND THE UNDERSIGNED CERTIFYING SURVEYOR
 ION THERE TO. (NOTE ALL RECORDED INSTRUMENTS REFERRED TO HEREIN ARE UNDERSTOOD
 HE PUBLIC RECORDS OF WALTON COUNTY, FLORIDA.)

1 AND 12 FACTS WHICH WOULD BE DISCLOSED BY AN ACCURATE AND COMPREHENSIVE SURVEY
 HEREIN DESCRIBED ARE PLOTTED AND SHOWN HEREIN.

2 ARE BLANKET IN NATURE AND HEREIN CANNOT BE DESCRIBED OR ACCURATELY PLOTTED.

LAND ENGINEERING SERVICES, INC.

P.O. BOX 49
 3751 U.S. HWY 90 E
 DEFUNIAK SPRINGS,
 FL 32433

PHONE: 850-892-3639
 FAX: 850-892-6326

LB#7544

**CLIENT:
 WALTON COUNTY
 SHERIFF'S OFFICE**

CERTIFIED TO:
 CLIENT:
 ALLIANT NATIONAL TITLE
 INSURANCE COMPANY;
 MITCHELL LAND & TITLE, INC;

DATE OF SURVEY:
 MARCH 22, 2023
 FIELD CREW CHIEF:
 SCOTT COOK
 PARCEL ID:
 27-5N-19-21000-001-0020

SURVEY ID#: 23471
 DRAWN BY:
 SETH SKINNER
 CHECKED BY:
 JANIE CARROLL

REVISED DATE:
 JUNE 1, 2023
 ADDED COMMITMENT

REVISED DATE:
 AUGUST 29, 2023
 CORRECTED
 WORDING ALONG
 NORTH LINE

NOTE: THIS SURVEY WAS
 ELECTRONICALLY SIGNED AND SEALED
 BY: BRAEDEN R. S. SKINNER, PSM ON
 AUGUST 29, 2023 AS PER THE RULES
 SET FORTH IN 5J-17 FAC PERMITTING
 ELECTRONIC SIGNATURES AND SEALS
 BY PROFESSIONAL SURVEYORS AND
 MAPPERS

SURVEYOR'S CERTIFICATE
 I, THE UNDERSIGNED BEING
 A LICENSED SURVEYOR AND
 MAPPER IN THE STATE OF
 FLORIDA, DO HEREBY CERTIFY
 THAT THE SURVEY AS SHOWN,
 TO THE BEST OF MY KNOWLEDGE,
 MEETS THE REQUIREMENTS OF
 THE STANDARDS OF PRACTICE
 OF THE STATE OF FLORIDA (CHAPTER
 5J -17 FLORIDA ADMINISTRATIVE
 CODE PURSUANT TO CHAPTER
 472, AND CHAPTER 461 OF THE
 FLORIDA STATUTES EXCEPT AS
 OTHERWISE NOTED

SURVEY MAP AND REPORT OR
 THE COPIES THEREOF ARE NOT
 VALID WITHOUT THE SIGNATURE
 AND THE ORIGINAL RAISED SEAL
 OF A FLORIDA LICENSED SURVEYOR
 AND MAPPER



BRAEDEN R.S. SKINNER
 FLORIDA PSM NUMBER: 7327

Walton County Property Appraiser

Homestead Application

Apply for Homestead Exemption

Income and Expense Form

Income and Expense Form

Parcel Summary

Parcel ID 27-5N-19-21000-001-0040
 Location Address DEFUNIAK SPRINGS 32433
 Brief Tax Description NE4 OF NW4 LYING E OF ST RD #83 AND N & W OF ST RD #2 IN SEC 27-5N-19W OR 3287-852 OR 3288-1297
(Note: Not to be used on legal documents.)
 Property Use Code COUNTY (8600)
 Sec/Twp/Rng 27-5N-19
 Tax District COUNTY (5)
 Millage Rate 8.3537
 Acreage 7.58
 Homestead N

[View Map](#)

Owner Information

Primary Owner
WALTON COUNTY BOARD OF COUNTY COMMISSIONERS
 161 E SLOSS AVE
 DEFUNIAK SPRINGS, FL 32433

Preliminary Values

| | 2023 Preliminary Values |
|-----------------------------|-------------------------|
| Building Value | \$0 |
| Extra Features Value | \$0 |
| Land Value | \$1,023 |
| Land Agricultural Value | \$1,023 |
| Agricultural (Market) Value | \$13,644 |
| Just (Market) Value | \$13,644 |
| Assessed Value | \$1,023 |
| Exempt Value | \$1,023 |
| Taxable Value | \$0 |
| Differential | \$0 |

Land Information

| Land Use | Number of Units | Unit Type | Acres | Frontage |
|-----------------------|-----------------|-----------|-------|----------|
| 005401 - TIMBER 1A | 7.58 | AC | 7.58 | 0 |
| 009911 - MKTVALAG <40 | 7.58 | AC | 7.58 | 0 |

Sales

| Multi Parcel | Sale Date | Sale Price | Instrument | Book/Page | Qualification | Vacant/Improved | Grantor | Grantee |
|--------------|-----------|------------|------------|------------------|---------------|-----------------|--|--|
| N | 5/2/2023 | \$100 | WD | <u>3288/1297</u> | Unqualified | Vacant | ADKINSON MICHAEL A JR OFFICE OF THE SHERIFF | WALTON COUNTY BOARD OF COUNTY COMMISSIONERS |
| N | 4/19/2023 | \$100,000 | WD | <u>3287/852</u> | Qualified | Vacant | WILKERSON GLADYS | ADKINSON MICHAEL A JR OFFICE OF THE SHERIFF |

Gillespie, Toni T

From: Mall, Rudolph <rmall@Dewberry.com>
Sent: Wednesday, August 9, 2023 3:22 PM
To: DL CHD66 EHWeb
Cc: Godwin, Charylene G
Subject: FW: Glendale Fire Station - Septic Application
Attachments: Topographic Survey.pdf; Parcel Map.pdf; dh4015-Application for Construction Permit.pdf; Variance DH4057.pdf; 50150622-Glendale FD_2023-8-9.pdf; glendale fire department report ds.pdf

Follow Up Flag: Follow up
Flag Status: Flagged

EXTERNAL EMAIL: DO NOT CLICK links or open attachments unless you recognize the sender and know the content is safe.

Hello,

Walton County is proposing to construct a new fire station located in Glendale, Walton County, FL (see parcel map). The existing site currently has no water or sewer. The building footprint will be the same exact footprint as the Choctaw Beach Fire Station that was recently permitted with you guys. Similar to Choctaw Beach, the Glendale fire station will be utilizing a septic system. Attached are the draft applications for the DH4015 sewage treatment and the DH4057 DEP Variance form (for PPE equipment entering the system). I'll forward signatures once I confirm this is what you need. I plan on flagging the site sometime next week. Will let you know.

Thanks,
Rudy Mall

Rudy Mall, PE

Project Engineer
877 North County Highway 393
Santa Rosa Beach, FL 32459-5370
D 850.571.1249 C 850.635.2620
LICENSED PE



.....
The social media icons are small, black, and arranged horizontally. From left to right: LinkedIn (in), Twitter (bird), Instagram (camera), and YouTube (play button).
www.dewberry.com

From: Mall, Rudolph
Sent: Wednesday, August 9, 2023 3:12 PM
To: King, Robert E <Robert.King@flhealth.gov>
Cc: Godwin, Charylene G <Charylene.Godwin@flhealth.gov>; Steele, Crystal C <Crystal.Steele@flhealth.gov>
Subject: Glendale Fire Station - Septic Application

Hey Robert – hope all is well. Walton County is proposing to construct a new fire station located in Glendale, Walton County, FL (see parcel map). The existing site currently has no water or sewer. The building footprint will be the same exact footprint as the Choctaw Beach Fire Station that was recently permitted with you guys. Similar to Choctaw Beach, the Glendale fire station will be utilizing a septic system. Attached are the draft applications for the DH4015 sewage treatment and the DH4057 DEP Variance form (for PPE equipment entering the system). I'll forward signatures once I confirm this is what you need. I plan on flagging the site sometime next week. Will let you know.

Thanks,
Rudy

Rudy Mall, PE

Project Engineer
877 North County Highway 393
Santa Rosa Beach, FL 32459-5370
D 850.571.1249 C 850.635.2620
LICENSED PE



.....
[in](#) [Twitter](#) [Instagram](#) [YouTube](#)
www.dewberry.com

CONFIDENTIALITY NOTICE: This e-mail message, including any attachments, is intended only for the use of the person(s) to whom it is addressed and may contain confidential and privileged information. Any unauthorized review, use, disclosure, copying, or distribution is prohibited. If you are not the intended recipient, please contact the sender by reply e-mail and destroy all copies of the original message.

From: Floyd, Suzanne M <Suzanne.Floyd@flhealth.gov>
Sent: Monday, August 21, 2023 4:47 PM
To: Mall, Rudolph <rmall@Dewberry.com>
Cc: DL CHD66 EHWeb <DLCHD66EHWeb@flhealth.gov>
Subject: Glendale Fire Department

[CAUTION] External Email. DO NOT click links or open attachments unless expected. Please use the "Phish Alert" button to report all suspicious emails.

Good Afternoon,

After reviewing the septic application for the Glendale Fire Department there are a few things we still need.

- 1) Will the building be on municipal water or a private well? **Private Well**
 - a. If it is municipal water, we need the name of the system on the application. We will also need the proposed water meter location and where the water line will enter the building on the site plan.
 - b. If it is a private well, we need the proposed location of the well and where the water line will connect to the building on the site plan. The private well would need to be permitted as a Limited Use Well and would need to be at least 100 ft from any part of the septic system. **Noted. A copy of the Limited Use Well permit application will be provided prior to construction. Proposed septic tank is approximately 300 ft from the water well location.**
- 2) Please indicate on the site plan where the septic system is to be located and which direction the drainfield is to be in. You can indicate where the tank is to be located and then rough sketch in where the drain field should be, we will draw it in to scale once the fieldwork is completed. **Please see attached updated Utility Plan which shows tank and drain field location.**
- 3) Please specify on the application page if any additional people will be working and/or eating at the Fire Station besides the around the clock personnel. This might be cleaning staff, maintenance staff, etc.
- 4) Please specify if maintenance and washing of the fire trucks will occur on site.

Thank you,
Suzanne M. Floyd
Environmental Specialist III

Environmental Health
Florida Department of Health Walton County
362 State Highway 83
Defuniak Springs, FL 32433
Phone: 850-892-8021, x6457
Fax: (850) 892-8025
Suzanne.Floyd@flhealth.gov

Please click on the link below to answer a brief survey on your **Customer Satisfaction**.
Thank you.

<https://www.surveymonkey.com/r/JSZMKRH>

Mission: To protect, promote & improve the health of all people in Florida through integrated state, county and community efforts.

Please Note: Florida has a very broad public records law. Most written communications to or from state officials regarding state business are public records available to the public and media upon request. Your email communication may therefore be subject to public disclosure.

CONFIDENTIALITY NOTICE: This e-mail message, including any attachments, is intended only for the use of the person(s) to whom it is addressed and may contain confidential and privileged information. Any unauthorized review, use, disclosure, copying, or distribution is prohibited. If you are not the intended recipient, please contact the sender by reply e-mail and destroy all copies of the original message.

Floyd, Suzanne M

From: Mall, Rudolph <rmall@dewberry.com>
Sent: Tuesday, August 22, 2023 8:39 AM
To: Floyd, Suzanne M
Cc: DL CHD66 EHWeb
Subject: RE: Glendale Fire Department
Attachments: Utility Plan - Glendale.pdf

You don't often get email from rmall@dewberry.com. [Learn why this is important](#)

EXTERNAL EMAIL: DO NOT CLICK links or open attachments unless you recognize the sender and know the content is safe.

Hi Suzanne – please see below responses.

- 1) Will the building be on municipal water or a private well? **Private Well**
 - a. If it is municipal water, we need the name of the system on the application. We will also need the proposed water meter location and where the water line will enter the building on the site plan.
 - b. If it is a private well, we need the proposed location of the well and where the water line will connect to the building on the site plan. The private well would need to be permitted as a Limited Use Well and would need to be at least 100 ft from any part of the septic system. **Noted. A copy of the Limited Use Well permit application will be provided prior to construction. Proposed septic tank is approximately 300 ft from the proposed water well location.**
- 2) Please indicate on the site plan where the septic system is to be located and which direction the drainfield is to be in. You can indicate where the tank is to be located and then rough sketch in where the drain field should be, we will draw it in to scale once the fieldwork is completed. **Please see attached updated Utility Plan which shows tank and drain field location.**
- 3) Please specify on the application page if any additional people will be working and/or eating at the Fire Station besides the around the clock personnel. This might be cleaning staff, maintenance staff, etc. **No additional personnel.**
- 4) Please specify if maintenance and washing of the fire trucks will occur on site. **Yes, maintenance and washing will occur on site. Any runoff inside and outside the truck bays will be conveyed/directed to proposed stormwater management facility for water quality treatment.**

Thank you,
Rudy

Rudy Mall, PE

Project Engineer
877 North County Highway 393
Santa Rosa Beach, FL 32459-5370
D 850.571.1249 C 850.635.2620
LICENSED PE

 **Dewberry**



Gillespie, Toni T

From: Mall, Rudolph <rmail@Dewberry.com>
Sent: Tuesday, August 22, 2023 8:39 AM
To: Floyd, Suzanne M
Cc: DL CHD66 EHWeb
Subject: RE: Glendale Fire Department
Attachments: Utility Plan - Glendale.pdf

Some people who received this message don't often get email from rmail@dewberry.com. [Learn why this is important](#)

EXTERNAL EMAIL: DO NOT CLICK links or open attachments unless you recognize the sender and know the content is safe.

Hi Suzanne – please see below responses.

- 1) Will the building be on municipal water or a private well? **Private Well**
 - a. If it is municipal water, we need the name of the system on the application. We will also need the proposed water meter location and where the water line will enter the building on the site plan.
 - b. If it is a private well, we need the proposed location of the well and where the water line will connect to the building on the site plan. The private well would need to be permitted as a Limited Use Well and would need to be at least 100 ft from any part of the septic system.
Noted. A copy of the Limited Use Well permit application will be provided prior to construction. Proposed septic tank is approximately 300 ft from the proposed water well location.
- 2) Please indicate on the site plan where the septic system is to be located and which direction the drainfield is to be in. You can indicate where the tank is to be located and then rough sketch in where the drain field should be, we will draw it in to scale once the fieldwork is completed. **Please see attached updated Utility Plan which shows tank and drain field location.**
- 3) Please specify on the application page if any additional people will be working and/or eating at the Fire Station besides the around the clock personnel. This might be cleaning staff, maintenance staff, etc. **No additional personnel.**
- 4) Please specify if maintenance and washing of the fire trucks will occur on site. **Yes, maintenance and washing will occur on site. Any runoff inside and outside the truck bays will be conveyed/directed to proposed stormwater management facility for water quality treatment.**

Thank you,
Rudy

Rudy Mall, PE

Project Engineer
877 North County Highway 393
Santa Rosa Beach, FL 32459-5370
D 850.571.1249 C 850.635.2620
LICENSED PE

 **Dewberry**

From: Floyd, Suzanne M <Suzanne.Floyd@flhealth.gov>
Sent: Monday, August 21, 2023 4:47 PM
To: Mall, Rudolph <rmall@Dewberry.com>
Cc: DL CHD66 EHWeb <DLCHD66EHWeb@flhealth.gov>
Subject: Glendale Fire Department

[CAUTION] External Email. DO NOT click links or open attachments unless expected. Please use the "Phish Alert" button to report all suspicious emails.

Good Afternoon,

After reviewing the septic application for the Glendale Fire Department there are a few things we still need.

- 1) Will the building be on municipal water or a private well? **Private Well**
 - a. If it is municipal water, we need the name of the system on the application. We will also need the proposed water meter location and where the water line will enter the building on the site plan.
 - b. If it is a private well, we need the proposed location of the well and where the water line will connect to the building on the site plan. The private well would need to be permitted as a Limited Use Well and would need to be at least 100 ft from any part of the septic system.
Noted. A copy of the Limited Use Well permit application will be provided prior to construction. Proposed septic tank is approximately 300 ft from the water well location.
- 2) Please indicate on the site plan where the septic system is to be located and which direction the drainfield is to be in. You can indicate where the tank is to be located and then rough sketch in where the drain field should be, we will draw it in to scale once the fieldwork is completed. **Please see attached updated Utility Plan which shows tank and drain field location.**
- 3) Please specify on the application page if any additional people will be working and/or eating at the Fire Station besides the around the clock personnel. This might be cleaning staff, maintenance staff, etc.
- 4) Please specify if maintenance and washing of the fire trucks will occur on site.

Thank you,
Suzanne M. Floyd
Environmental Specialist III

Environmental Health
Florida Department of Health Walton County
362 State Highway 83
Defuniak Springs, FL 32433
Phone: 850-892-8021, x6457
Fax: (850) 892-8025
Suzanne.Floyd@flhealth.gov

Please click on the link below to answer a brief survey on your **Customer Satisfaction**.
Thank you.

<https://www.surveymonkey.com/r/JSZMKRH>

Mission: To protect, promote & improve the health of all people in Florida through integrated state, county and community efforts.

Please Note: Florida has a very broad public records law. Most written communications to or from state officials regarding state business are public records available to the public and media upon request. Your email communication may therefore be subject to public disclosure.

CONFIDENTIALITY NOTICE: This e-mail message, including any attachments, is intended only for the use of the person(s) to whom it is addressed and may contain confidential and privileged information. Any unauthorized review, use, disclosure, copying, or distribution is prohibited. If you are not the intended recipient, please contact the sender by reply e-mail and destroy all copies of the original message.

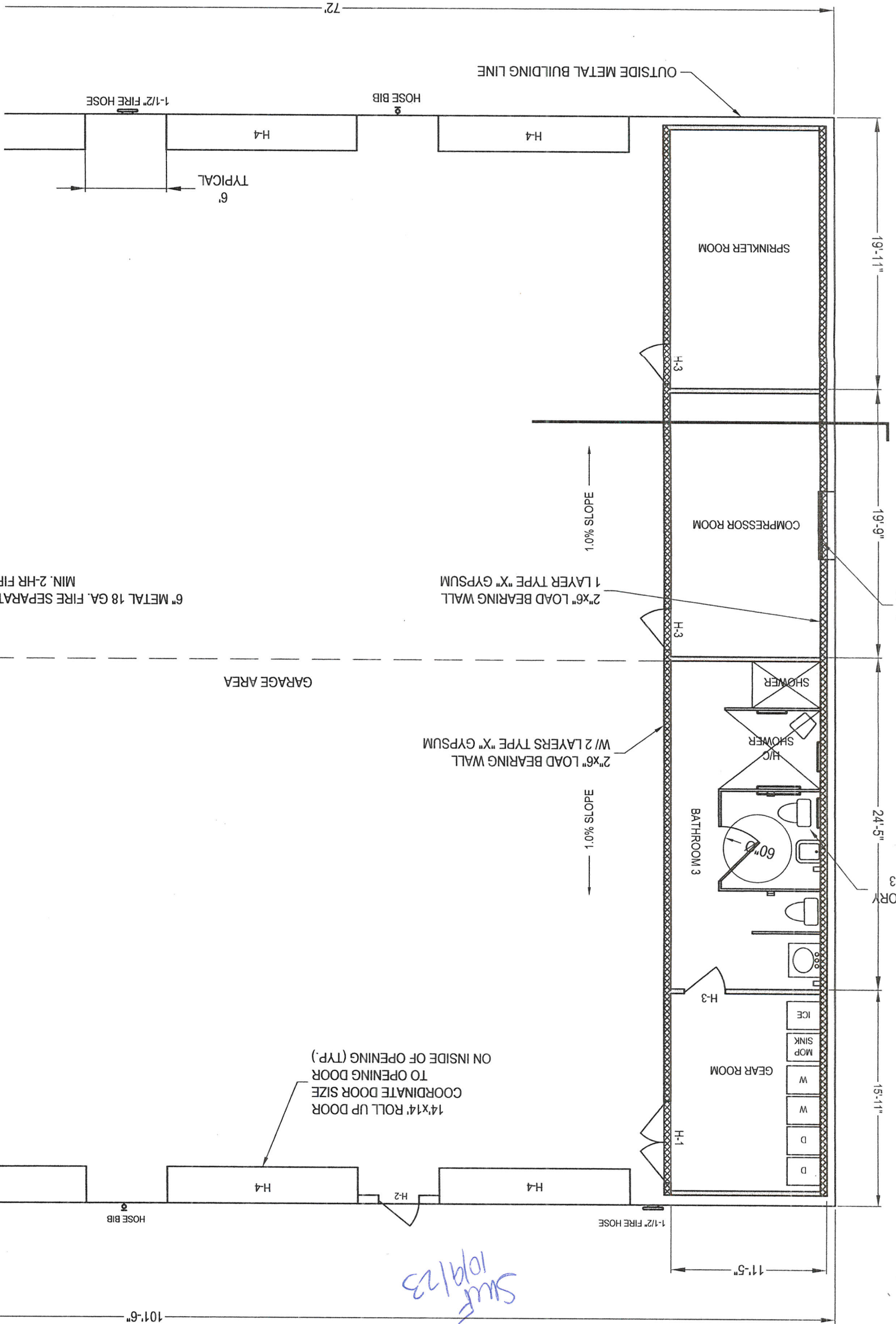

72'-0" (Overall width)
 1-1/2" FIRE HOSE
 HOSE BIB
 H-4
 6' TYPICAL
 1-1/2" FIRE HOSE

6" METAL 18 GA. FIRE SEPARAT
 MIN. 2-HR FIF

GARAGE AREA

14'x14' ROLL UP DOOR
 COORDINATE DOOR SIZE
 TO OPENING (TYP.)
 ON INSIDE OF OPENING

*SWF
 10/9/23*

101'-6" (Overall length)
 REAR (NORTH)

19'-11" (Room 1)
 19'-9" (Room 2)
 24'-5" (Room 3)
 15'-11" (Room 4)

1.0% SLOPE

1.0% SLOPE

2"x6" LOAD BEARING WALL
 1 LAYER TYPE "X" GYPSUM

2"x6" LOAD BEARING WALL
 W/ 2 LAYERS TYPE "X" GYPSUM

SPRINKLER ROOM

COMPRESSOR ROOM

BATHROOM 3

GEAR ROOM

D D
 W W
 MOP SINK
 ICE

SHOWER

SHOWER

H-3

H-3

H-3

H-3

H-1

H-4

H-4

H-4

H-4

H-2

HOSE BIB

1-1/2" FIRE HOSE

11'-5" (Room 4 width)

ST

1.3

SOR



FLORIDA DEPARTMENT OF Environmental Protection

Northwest District
160 W. Government Street, Suite 308
Pensacola, Florida 32502-5740
NWD_EPOST@dep.state.fl.us

Ron DeSantis
Governor

Jeanette Nuñez
Lt. Governor

Shawn Hamilton
Secretary

March 18, 2024

Walton County Board of County Commissioners
c/o Rudy Mall, Dewberry Engineers, Inc.
877 N County Road 393
Santa Rosa Beach, FL 32459
(rmall@deberry.com)

Re: Glendale Fire Department – FLAB07441
Parcel No: 27-5N-19-21000-001-0040
FDOH Walton County #AP1985236
No Objection to the Use of an Onsite Sewage Treatment and Disposal System

Dear Mr. Mall:

This letter is sent in response to the proposed use of an onsite sewage treatment and disposal system (OSTDS) at the Glendale Fire Department establishment located at the northeast quadrant of the intersection of Hwy 2E & Hwy 83 in DeFuniak Springs, Walton County.

Based on a review of the information submitted to the Department (DEP) by the Florida Department of Health, Walton County, DEP has determined the following regarding the proposed use of an OSTDS at the establishment.

DEP determined the following with regard to the management of sewage wastes:

- The establishment will be required to obtain a wastewater facility permit under Chapter 403, F.S., for the entire flow of the establishment. DEP objects to the use of an OSTDS at this establishment.
- The establishment will be required to obtain a wastewater facility permit under Chapter 403, F.S., for the toxic, hazardous, or industrial wastewater-related flow and DEP does not object to the use of an OSTDS for only the domestic or commercial wastewater flow.
- The establishment will not be required to obtain a wastewater facility permit under Chapter 403, F.S., at this time, but DEP objects to the use of an OSTDS for the toxic, hazardous, or industrial wastewater-related flow (see the project description below regarding the management of any toxic, hazardous, or industrial wastewater), and does not object to the use of an OSTDS for only the domestic or commercial wastewater flow.

- The establishment will not be required to get a wastewater facility permit under Chapter 403, F.S., at this time and DEP has no objection to use of an OSTDS-permit for the type and quantity of wastewater generated by the establishment if a variance under section 381.0065, F.S., is granted. This is based on the information presented to DEP (see the project description below regarding the management of any toxic, hazardous, or industrial wastewater). If there is a change in circumstances that affects the waste discharged, a new review is necessary.

According to the information provided to DEP, the project for utilization of an OSTDS for onsite washing of personal protective equipment (PPE) is considered to be industrial waste. The wastewater flow is approximately 350 gallons per day and includes industrial wastewater from the laundry for this facility.

This letter regarding the use of an OSTDS is specific for the proposed project and/or purpose requested and is not transferable for any other use or any other owner or tenant without prior approval from DEP. The continued use of the OSTDS is contingent upon satisfactory system performance. When an approved sewage collection system becomes available, the owner of this system may be required to apply for a connection. Also, should the OSTDS prove to be inadequate to achieve acceptable treatment and disposal, or should regulations change, this establishment may be required to obtain a permit for a wastewater facility.

If this letter is used to obtain an OSTDS permit, it will be incorporated into the permit record. The use of this letter to obtain an OSTDS permit constrains the property owner, subsequent owners and leaseholders of the installation to agree to routine inspections of that facility and its source of wastes during reasonable business hours by DEP and/or the Florida Department of Health County Health Department.

Many commonly encountered materials may not be disposed of in an OSTDS because they are not biodegradable by the system, will contaminate groundwater, or impair the function of the system. Some examples of inappropriate materials are: solvents, thinners, fuels, lubricants, hydraulic oil, vehicle radiator fluid, pesticides, herbicides, inks, mineral acids, lye, photographic wastes, and chemical lab wastes. Disposal of all wastes shall be in accordance with appropriate regulations. This Department has the duty and reserves the right to take enforcement action for violations of ground water quality and surface water quality. Such enforcement action may, in part, require the owner at his or her own expense to install and operate a ground water monitoring system, prepare a contamination assessment plan, and provide remedial action to remove and dispose of environmentally offensive and health-threatening materials from the affected soil and water. Additionally, the Department may seek court-imposed penalties of up to \$10,000 per day for each day of water quality violation.

If you have any questions concerning this matter, please contact me at 850-595-0584.

Sincerely,



William A. Evans, P.E.
Water and Wastewater Permitting Manager

cc:

Suzanne Floyd, Florida DOH in Walton County (suzanne.floyd@flhealth.gov)

DEP Onsite Sewage Program (Elke.Ursin@FloridaDEP.gov)

Tony Cornman, Deputy County Administrator, Walton County (cortony@co.walton.fl.us)

Buddy Wright, Walton County Public Works Director (wribuddy@co.walton.fl.us)

Scott Caraway, Walton County Deputy Public Works Director (carscott@co.walton.fl.us)

Melinda Gates, Walton County Environmental Manager (gatmelinda@co.walton.fl.us)

Maurice Barker, FDEP (maurice.barker@floridadep.gov)

APPENDIX F

**5,000 Gal Water
Storage Tank Pad
Detail**

| REVISIONS | | | | |
|-----------|-----------------------------|----------|-------|----------|
| REV. | DESCRIPTION | DATE | DRAWN | APPROVED |
| A | FIRST ISSUE | 04/07/17 | BAF | --- |
| B | DIM'S ADDED TO SECTION VIEW | 10/08/17 | BAF | --- |

GENERAL NOTES

G1 UNLESS INDICATED OTHERWISE BY AQUAMATE IN WRITING, SITE PREPARATION FOR THE TANK SHALL BE BY THE CUSTOMER. GUIDELINES FOR SITE PREPARATION ARE AS OUTLINED BELOW.

G2 VEHICULAR TRAFFIC ON THE COMPLETED SUB-GRADE SHOULD BE LIMITED. MARKS OR RUTS LEFT IN THE SUBGRADE BY VEHICULAR TRAFFIC SHOULD BE REPAIRED AS PER THE GUIDELINES SUPPLIED.

G3 WHEN IN DOUBT THE CUSTOMER SHALL SEEK ADVICE FROM THE AQUAMATE REPRESENTATIVE.

SITE SELECTION

S1 IN THE SELECTION OF THE LOCATION FOR THE PLACEMENT OF THE TANK, A COMPETENT PERSON APPOINTED BY THE CUSTOMER SHALL INSPECT THE SITE TO ENSURE IT IS SUITABLE FOR PURPOSE AND THE TANK WILL NOT CAUSE FAILURE OF THE SOIL ON THE SITE.

S2 ON SITES WHERE FILL IS REQUIRED ON SLOPES OF 1:8 (VERTICAL TO HORIZONTAL) OR GREATER, SERIES OF PARALLEL, BENCHED TERRACES SHALL BE EXCAVATED OVER THE AREAS TO BE FILLED.

S3 RETAINING WALLS, WHERE REQUIRED TO SUPPORT THE FILL, SHALL BE TO APPLICABLE CODES AND STANDARDS

FOUNDATION PREPARATION

F1 CLEAR ALL DEBRIS, STRIP VEGETATION AND REMOVING ORGANIC MATTER, SHRUBS, TIMBER STUMPS, BOULDERS, RUBBLE AND THE LIKE, THEN TRIM NATURAL GROUND TO GIVE CORRECT LEVELS AND PROFILES AS THE BASIS FOR CONSTRUCTING THE HARDSTAND PLATFORM TO SUPPORT THE TANK.

F2 A LAYER OF STRUCTURAL MATERIAL WITH A MAXIMUM PARTICLE SIZE OF 0.25", AT LEAST 4" THICK, SHALL BE PLACED IN NEAR-HORIZONTAL LAYERS OF UNIFORM THICKNESS IN MAXIMUM LIFTS OF 4" DEPOSITED SYSTEMATICALLY ACROSS THE FILL AREA AND COMPACTED TO 98% MINIMUM STANDARD DENSITY RATIO TO DESIGN LEVEL.

F3 IN THE EVENT THE SOIL AT THE BASE OF THE EXCAVATION CANNOT BE COMPACTED AS SPECIFIED, SEEK ADDITIONAL ADVICE FROM AQUAMATE REPRESENTATIVE.

FOOTING CONSTRUCTION

C1 CONCRETE TO BE NORMAL WEIGHT WITH MIXES DESIGNED TO MEET A MINIMUM OF 3000 psi 28-DAY COMPRESSIVE STRENGTH. COVER TO BE 3" MINIMUM

C2 PROVIDE FORTECON MEMBRANE TO UNDERSIDE OF SLAB

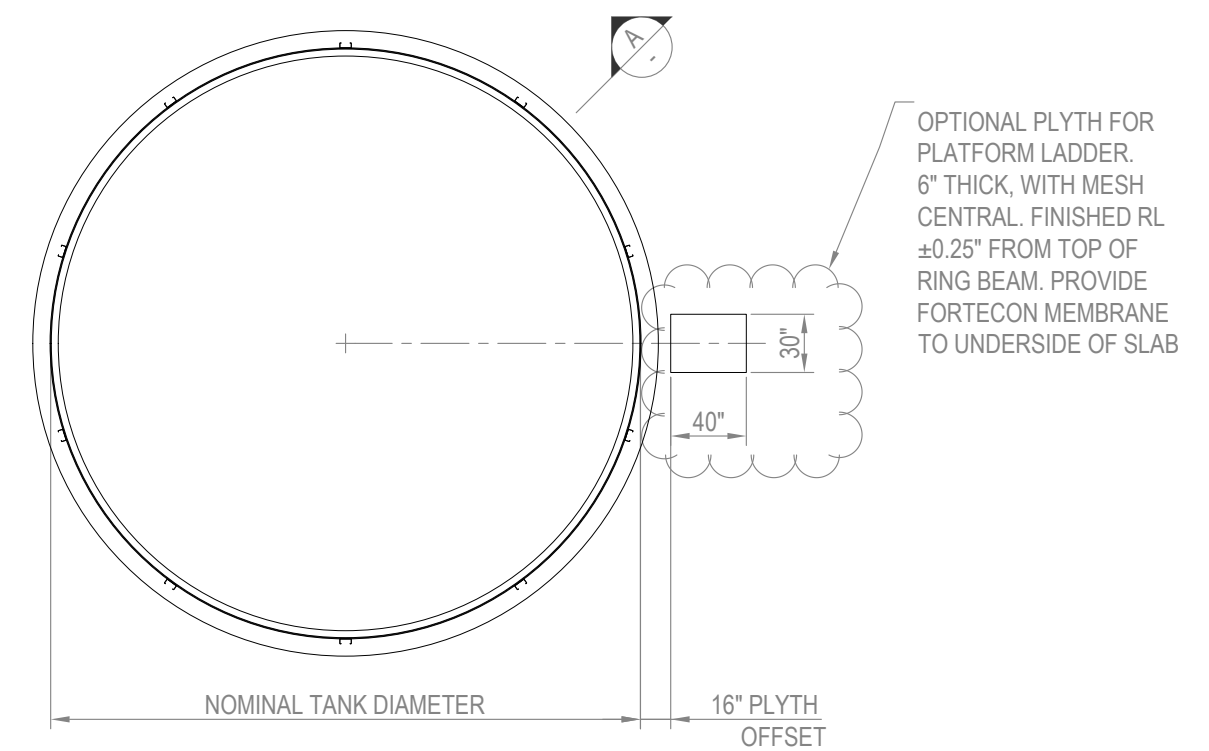

PLAN VIEW
SCALE: 1:100

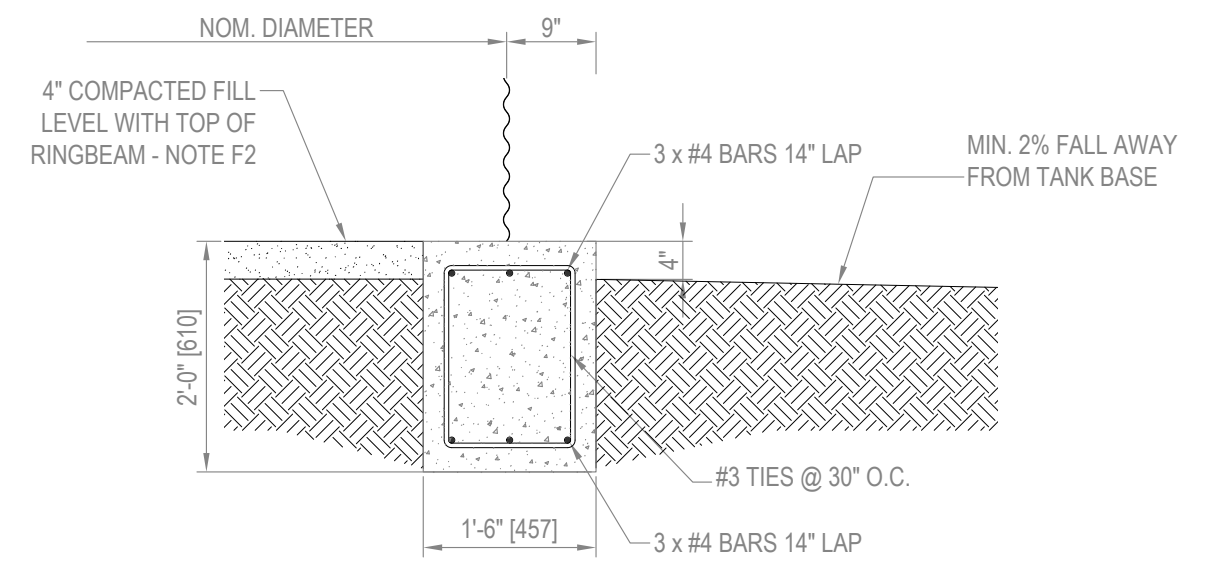

SECTION A
SCALE: 1:20

| | | | | | | |
|----------|------|-----------|---------|---|-----------|------------|
| INIT. | DATE | MATERIAL: | TITLE: | <p>STEEL TANK FOOTING 'MS' WATER TANK RANGE STANDARD COMPONENT</p> | | SHEET SIZE |
| DRAWN | BAF | 04/07/17 | N/A | | | |
| CHECKED | | | FINISH: | PROJECT No.: | DRG No.: | B |
| APPROVED | | | N/A | D035 | P000-1004 | |
| ISSUED | | | | SCALE: | SHEET: | WEIGHT: |
| | | | | 1:100 | 1 OF 1 | |



4132 Atlanta Hwy, Suite 110 #314, Loganville, GA 30052
844.320.TANK(8265) info@aquamatetanks.com aquamatetanks.com